

ALLGEMEINE HNO-INSTRUMENTE
GENERAL ENT INSTRUMENTS
INSTRUMENTS GENERAUX POUR ORL
INSTRUMENTOS GENERALES PARA ORL
STRUMENTI GENERALI PER ORL



Mikro-Skalpellklingen und -griffe
 Micro Scalpel Blades and Handles
 Micro lames de bistouris et manches
 Micro hojas de bisturi y mangos
 Micro lame per bisturi e manici

in Packungen à 10 St.
 in packages of 10 ea.
 en boîtes de 10 pièces
 en cajas de 10 c/u
 en scatole di 10 pezzi



12.0061 #61 **12.0062** #62 **12.0062S** #62S **12.0065** #65 **12.0067** #67 **12.0069** #69

Griffe für Klingen
 handles for blades
 manches pour lames
 mangos para hojas
 manici per bisturi

12.0061 - 12.0069



12.0180 100 mm
12.0182 125 mm
12.0184 155 mm
12.0186 180 mm
12.0188 200 mm



LANDOLD
12.0153
 21 cm bajonett

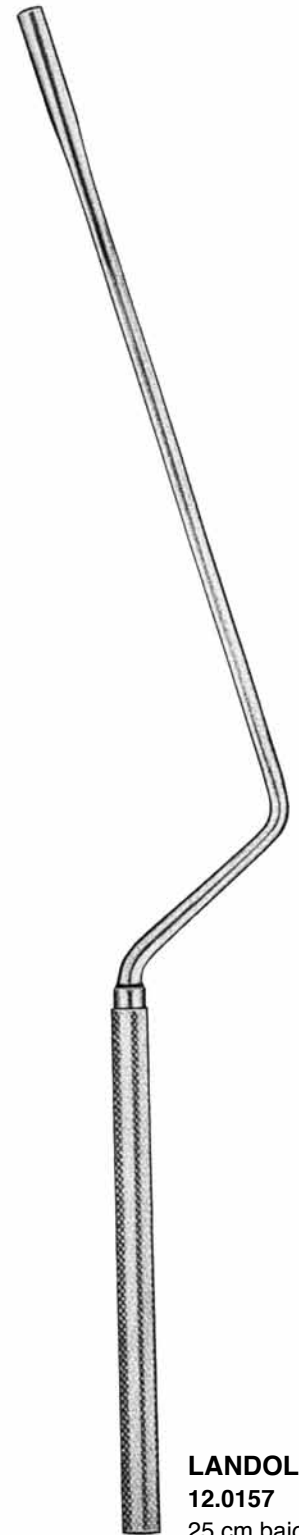

LANDOLD
12.0157
 25 cm bajonett

steril, in Packungen à 100
sterile, in packages of 100
stériles, en boîtes de 100
estériles, en cajas de 100
sterili, confezione da 100



12.0010
10



12.0011
11



12.0012
12

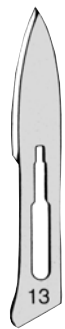

12.0013
13



12.0014
14



12.0015
15



12.0016
16



12.0017
17

Skalpellgriffe mit doppelter Aufnahme
Double Blade Handles
Manches á bistouris pour 2 lames
Mangos de bisturías para 2 hojas
Manici da bisturi per 2 lame



#5

12.0190
16 cm, 1,0 mm
12.0191
16 cm, 1,5 mm
12.0192
16 cm, 2,0 mm



#3

12.0195
12,5 cm, 1,0 mm
12.0196
12,5 cm, 1,5 mm
12.0197
12,5 cm, 2,0 mm

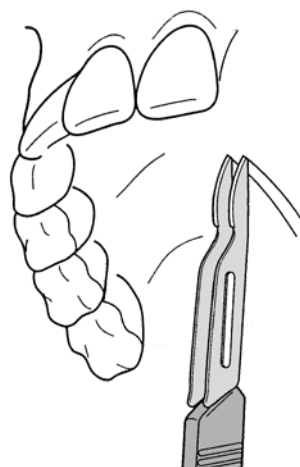

Griffe für Klagen
 Handles for Blades
 Manches pour lames
 Mangos para bisturis
 Manici per bisturi Fig.

Fig. 10,11,12,12d,13,14,15,15c,16,17,

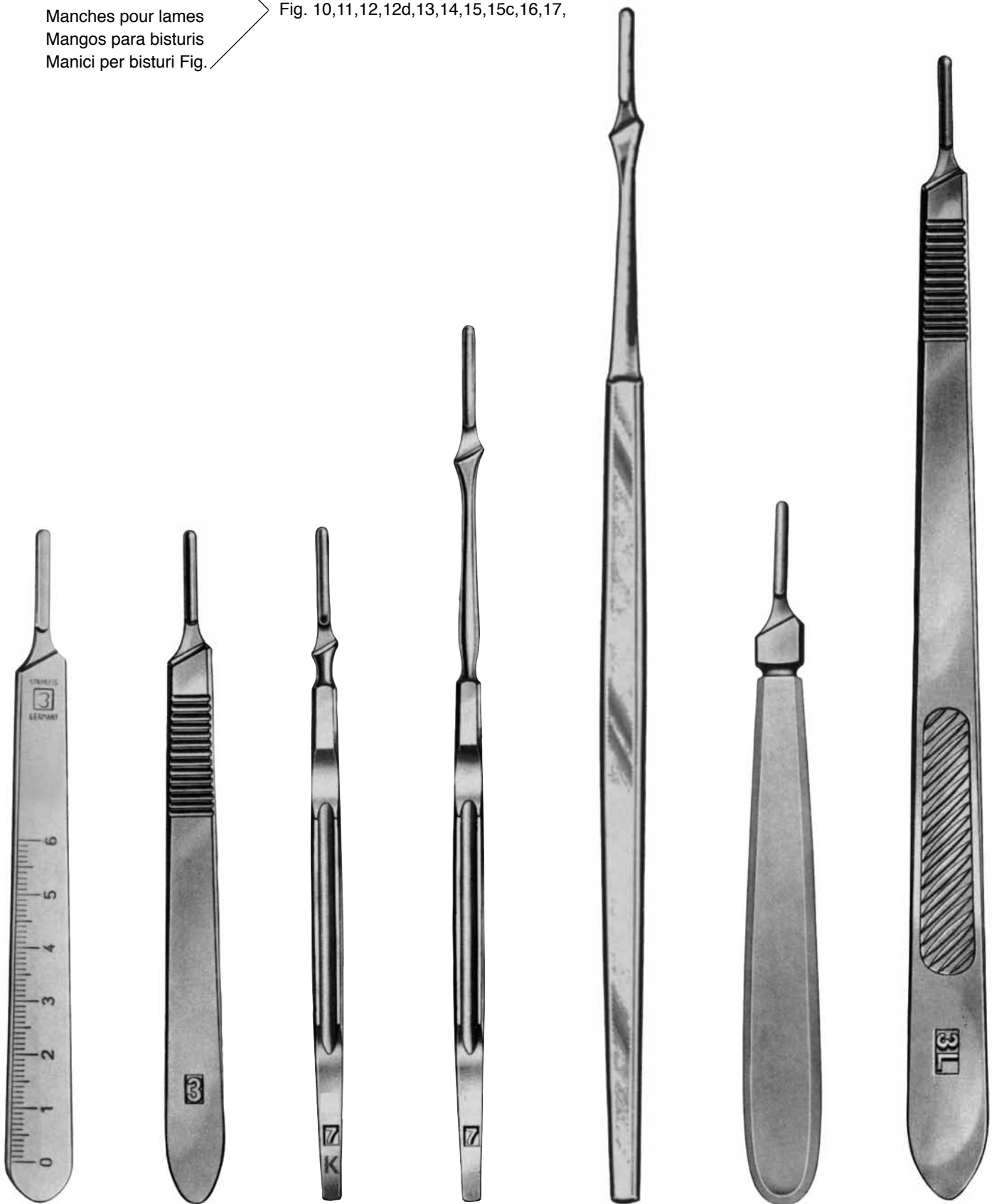

12.0101
 Technical #3

12.0103
 #3 12 cm

12.0106
 #7 K 12,5 cm

12.0107
 #7 16 cm

12.0127
 #7 L 22,5 cm

COLLIN
12.0108
 #8 13 cm

12.0113
 #3 L 21 cm

Griffe für Klagen
 Handles for Blades
 Manches pour lames
 Mangos para bisturis
 Manici per bisturi

Fig. 10,11,12,12d,13,14,15,15c,16,17,

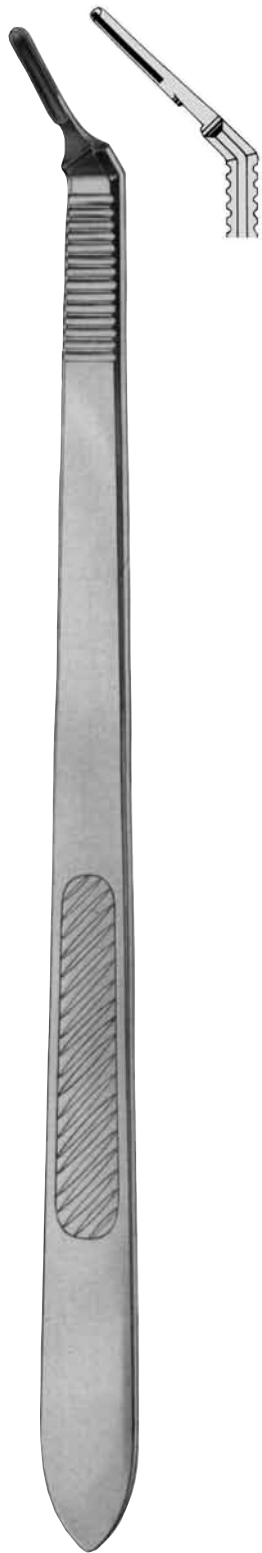

12.0115
 #3 L 20 cm



12.0123
 #5, 16 cm



12.0125
 #5, 16 cm



12.0133
 #3, 21cm



BARRON
12.0163
 #3 13 cm



12.0173
 12,5 cm

Kunststoffgriff
 plastic handle
 manche en plastique
 mango plástico
 manico plastica

steril, in Packungen à 100
 sterile, in packages of 100
 stériles, en boîtes de 100
 estériles, en cajas de 100
 sterili, confezione da 100



12.0018
18



12.0019
19



12.0020
20



12.0021
21



12.0022
22

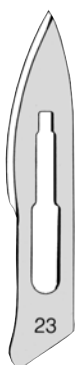

12.0023
23



12.0024
24



12.0025
25



12.0034
34



12.0036
36

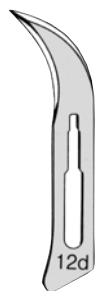

12.0042
12 d



12.0044
24 d



12.0045
15 c



12.0046
36 d

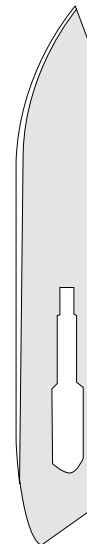

POST-MORTEM
12.0060
60

nicht steril
 not sterile
 pas stériles
 no estériles
 non sterile

Griffe für Klengen
Handles for Blades
Manches pour lames
Mangos para bisturis
Manici per bisturi

Fig. 18,19,20,21,22,23,24,25,34,36,44,46



12.0105
3/4 16 cm



12.0102
Technical #4



12.0104
#4 12 cm



COLLIN
12.0109
#9 14 cm

Griffe für Klengen
 Handles for Blades
 Manches pour lames
 Mangos para bisturis
 Manici per bisturi

Fig. 18,19,20,21,22,23,24,25,34,36,44,46

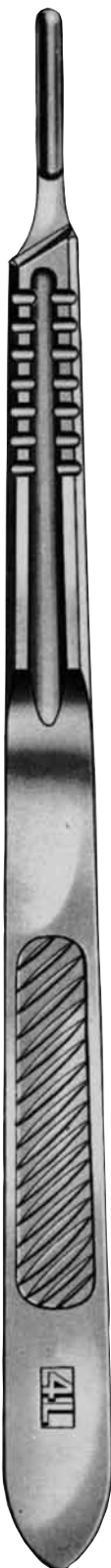

12.0114
 #4 L 21 cm



12.0117
 #4 L 20 cm



KLING-EX
12.0070

Skalpelklengen-Abnehmer
 Scalpel-blade remover
 Oteur-bistouris
 Quita hojas
 togliere-lame



Kunststoffgriff
 plastic handle
 manche en plastique
 mango plástico
 manico plastica

12.0174
 13,5 cm

SCHEREN
SCISSORS
CISEAUX
TIJERAS
FORBICI

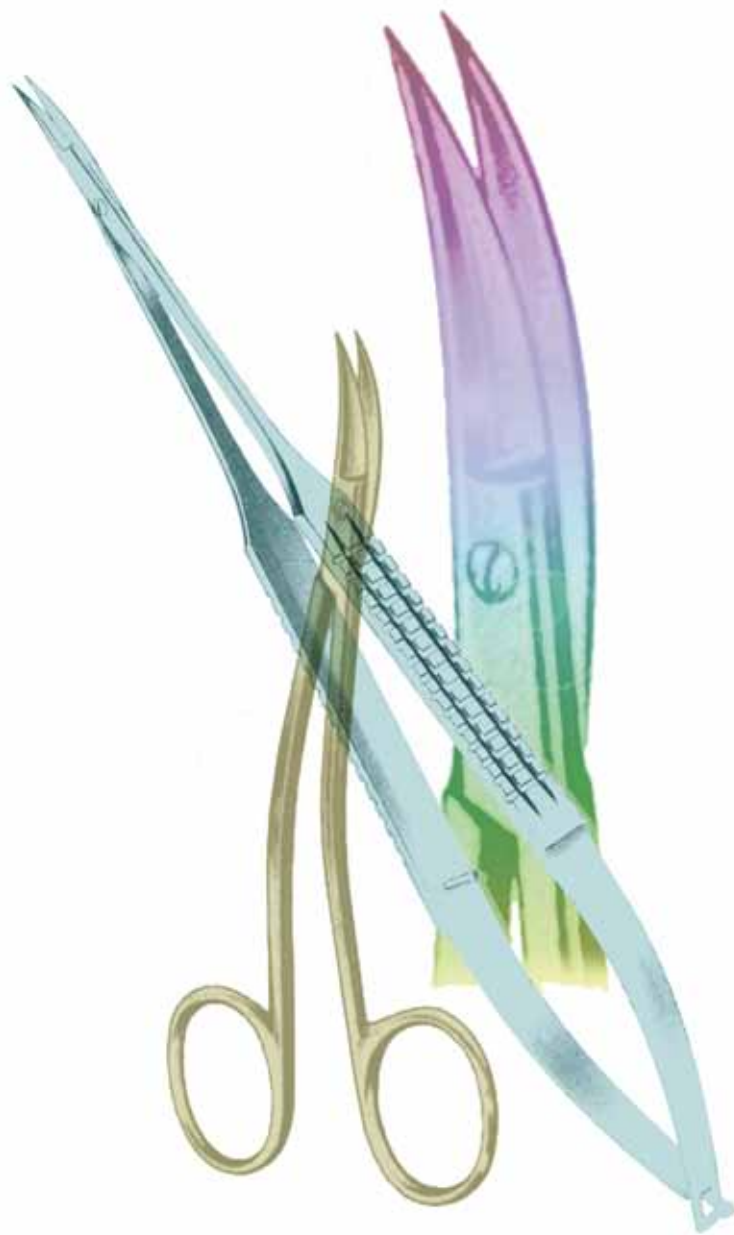

PRO-MED ist Ihnen behilflich bei der Zusammenstellung von Operationsbestecken für die verschiedensten Disziplinen. Fragen Sie nach unseren vorbereiteten OP-Bestecken.

For your convenience a wide variety of Suggested Operating Sets for most general and specialized procedures is available from **PRO-MED**. Please contact us or your local dealer.

PRO-MED vous propose de multiples compositions de boîtes opératoires multidisciplinaires. Demandez nos suggestions pour de nombreuses interventions.

PRO-MED le ayuda en componer varias cajas de instrumentos quirúrgicos. Pregunte por nuestro instrumental quirúrgico preparado.

Per la vostra comodità **PRO-MED** Vi aiuta nella raccolta di strumenti chirurgici per le varie discipline. Vi preghiamo di chiedere informazioni sui nostri set di strumenti chirurgici già preparati.



28.2120
12,5 cm / Ø 7mm
gerade / straight
droit / recto / retto

28.2121
12,5 cm / Ø 7 mm
gebogen / curved
courbe / curvo / curvo



28.2122
15 cm / Ø 8 mm
gerade / straight /
droit / recto / retto



28.2123
15 cm / Ø 8 mm
gebogen / curved /
courbe / curvo /
curvo



28.2133
15 cm / Ø 8 mm
gebogen / curved /
courbe / curvo /
curvo

stumpf / blunt /
mousses / romas /
smusse

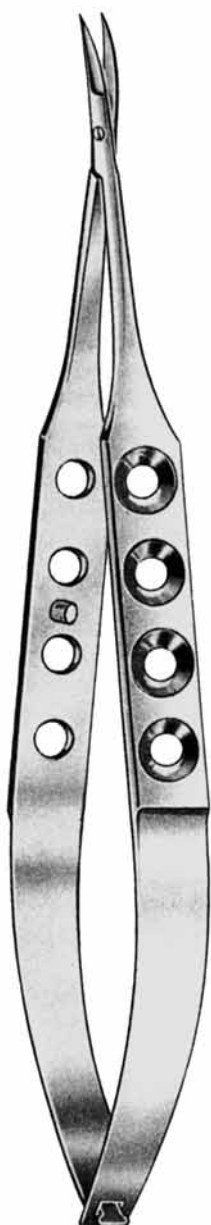

VANNAS
 28.2714 12 cm
 28.2718 16 cm



VANNAS
 28.2715 12 cm
 28.2719 16 cm



VANNAS
 28.2711 12 cm



YASARGIL
 28.2712 12 cm
 28.2716 16 cm
 28.2722 18,5 cm



YASARGIL
 28.2713 12 cm
 28.2717 16 cm
 28.2723 18,5 cm



MILLES
 28.2720 16 cm

gezahnt/serrated
 dentelés/dentada
 dentate



MILLES
 28.2721 16 cm

gezahnt/serrated
 dentelés/dentada
 dentate

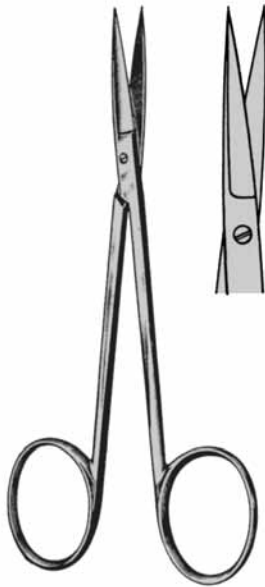

IRIS

- 13.0010 9,0 cm
- 13.0010SC** 9,0 cm
- 13.0012 10,5 cm
- 13.0012SC** 10,5 cm
- 13.0014 11,5 cm
- 13.0014SC** 11,5 cm



IRIS

- 13.0011 9,0 cm
- 13.0011SC** 9,0 cm
- 13.0013 10,5 cm
- 13.0013SC** 10,5 cm
- 13.0015 11,5 cm
- 13.0015 SC** 11,5 cm



IRIS

- 13.0012L 10,5 cm
- 13.0012LSC** 10,5 cm
- 13.0013L 10,5 cm
- 13.0013LSC** 10,5 cm

linkshändig / left handed /
 pour gaucher / para zurdo / per mano sinistra

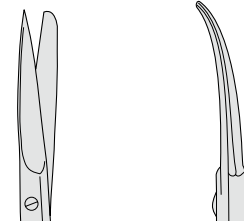

- 13.0022 10,0 cm
- 13.0016 11,5 cm
- 13.0023 10,0 cm
- 13.0017 11,5 cm

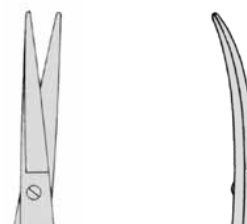

- 13.0018 11,5 cm
- 13.0019 11,5 cm



IRIS

mit grossen Ringen
with large rings
avec anneaux larges
con anillos grandes
con anelli grandi

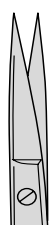

13.0032 10 cm



13.0033 10 cm

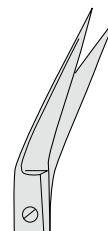

13.0041 9,0 cm

13.0043 10,5 cm

13.0043SC 10,5 cm

13.0045 11,0 cm

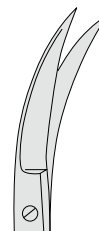

WALKER

13.0051 9,0 cm

13.0053 10,5 cm

13.0055 11,5 cm

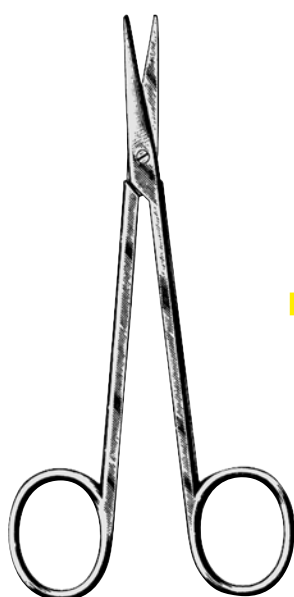

STRABISMUS

11,5 cm



13.0060

13.0060SC



13.0061

13.0061SC



STRABISMUS

13.0062 11,5 cm



STRABISMUS

13.0063 11,5 cm



13.0071
11 cm

13.0070
11 cm

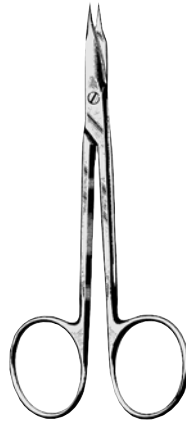

STEVENS

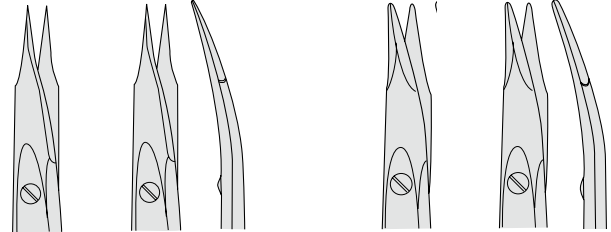

13.0076	13.0077	10,5 cm	13.0078	13.0079
13.0080	13.0081	11,5 cm	13.0082	13.0083
13.0080SC	13.0081SC	11,5 cm	13.0082SC	13.0083SC

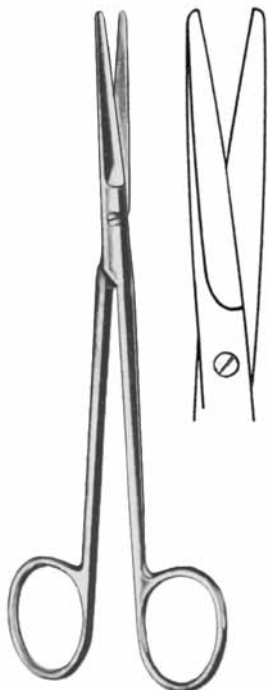

MIXTER
13.0130
15 cm

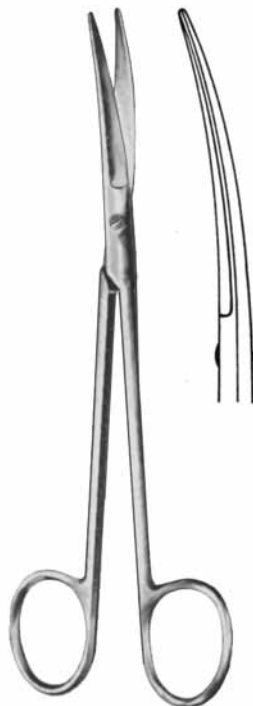

MIXTER
13.0131
15 cm

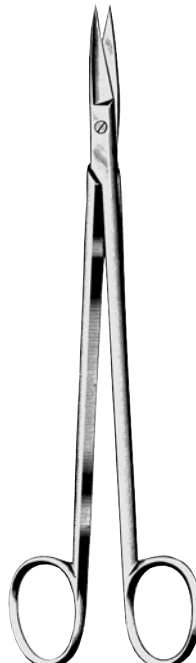

KELLY
13.0140
glatt / smooth
lisse / lisa / liscio

13.0146
gezahnt / serrated
dentées / dentadas /
dentata

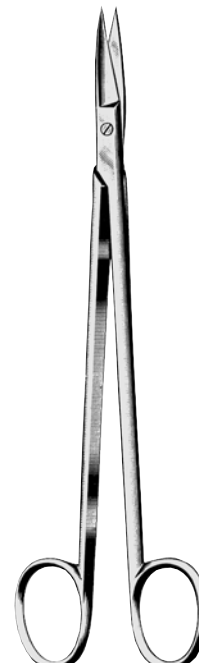

KELLY
13.0140SC
gerade / straight
droits / recta/ retto

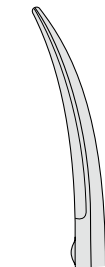

KELLY
13.0141 16 cm
glatt / smooth
lisse / lisa / liscio

13.0141SC 16 cm
gebogen / curved
courbe / curvo / curvo
13.0147
gezahnt / serrated
dentées / dentadas /
dentata



GRAZIL

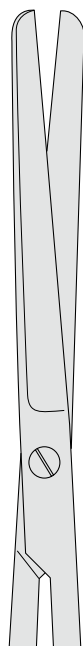

13.0152 13 cm
13.0154 14,5 cm

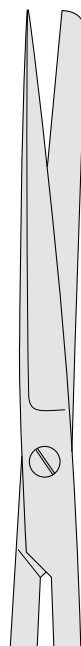

13.0162 13 cm
13.0164 14,5 cm



13.0172 13 cm
13.0174 14,5 cm



GRAZIL

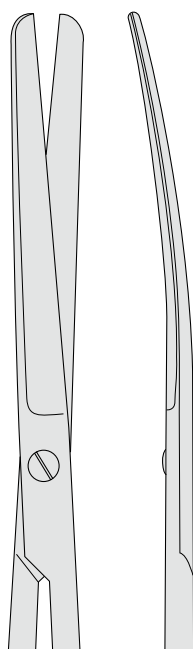

13.0153 13 cm
13.0155 14,5 cm

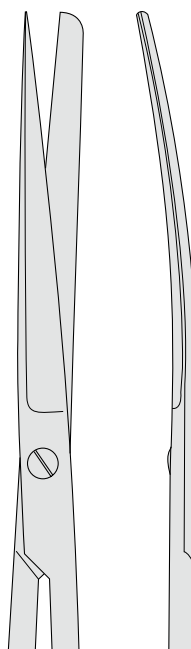

13.0163 13 cm
13.0165 14,5 cm

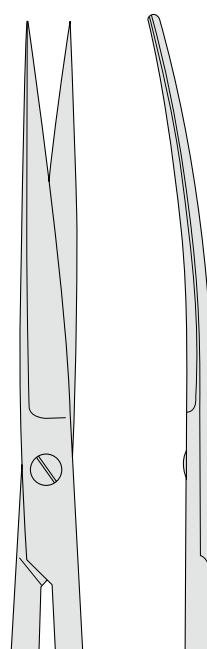

13.0173 13 cm
13.0175 14,5 cm

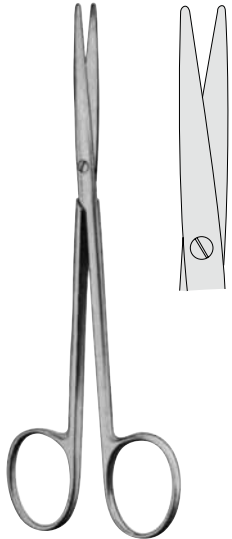

METZENBAUM-BABY

- 13.0594 11,5 cm
- 13.0594SC** 11,5 cm
- 13.0596 13,0 cm
- 13.0598 14,5 cm
- 13.0598SC** 14,5 cm



METZENBAUM-BABY

- 13.0595 11,5 cm
- 13.0595SC** 11,5 cm
- 13.0597 13,0 cm
- 13.0599 14,5 cm
- 13.0599SC** 14,5 cm



LAHEY-METZENBAUM



13.0752
15 cm

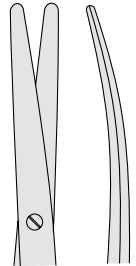

13.0753
15 cm

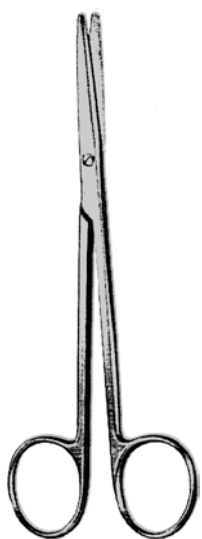

METZENBAUM

14,5 cm

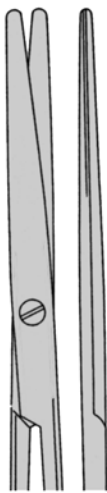

13.0600
13.0600L

linkshändig/left-handed/
pour gaucher/para zurdo/
per mano sinistra

13.0600SC

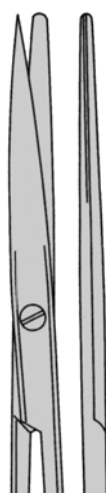

13.0620



13.0640

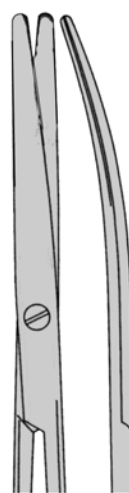

13.0601
13.0601L

linkshändig/left-handed/
pour gaucher/para zurdo/
per mano sinistra

13.0601SC

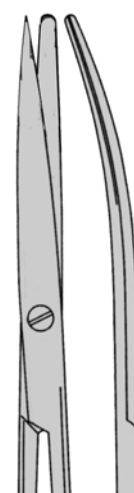

13.0621

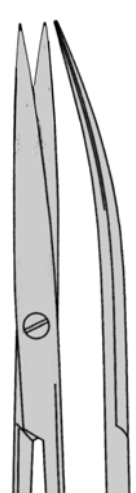

13.0641



stumpf - stumpf
blunt - blunt
mousses - mousses
romo - romo
smusso - smusso



spitz - stumpf
sharp - blunt
pointu - mousses
agudo - romo
appuntato - smusso



METZENBAUM

- 13.0602 18,0 cm **13.0602SC**
- 13.0602L 18,0 cm
linkshändig/left-handed/
pour gaucher/para zurdo/
per mano sinistra
- 13.0604 20,0 cm **13.0604SC**
- 13.0606 23,0 cm **13.0606SC**
- 13.0608 25,0 cm **13.0608SC**
- 13.0610 28,0 cm **13.0610SC**
- 13.0612 30,0 cm **13.0612SC**

METZENBAUM

- 13.0603 18,0 cm **13.0603SC**
- 13.0603L 18,0 cm
linkshändig/left-handed/
pour gaucher/para zurdo/
per mano sinistra
- 13.0605 20,0 cm **13.0605SC**
- 13.0607 23,0 cm **13.0607SC**
- 13.0609 25,0 cm **13.0609SC**
- 13.0611 28,0 cm **13.0611SC**
- 13.0613 30,0 cm **13.0613SC**

METZENBAUM

- 13.0622 18,0 cm
- 13.0624 20,0 cm
- 13.0626 23,0 cm
- 13.0628 25,0 cm
- 13.0630 28,0 cm

METZENBAUM

- 13.0623 18,0 cm
- 13.0625 20,0 cm
- 13.0627 23,0 cm
- 13.0629 25,0 cm
- 13.0631 28,0 cm



spitz - spitz
sharp - sharp
pointu - pointu
agudo - agudo
appuntato - appuntato

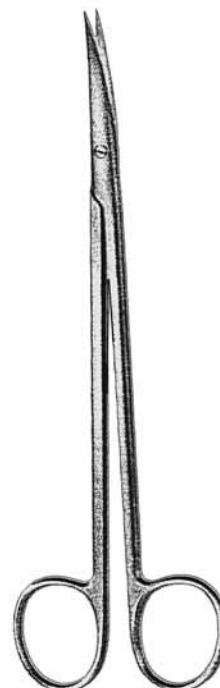

METZENBAUM

- 13.0642 18,0 cm
- 13.0644 20,0 cm **13.0644SC**
- 13.0646 23,0 cm
- 13.0648 25,0 cm
- 13.0650 28,0 cm **13.0650SC**

METZENBAUM

- 13.0643 18,0 cm
- 13.0645 20,0 cm **13.0645SC**
- 13.0647 23,0 cm
- 13.0649 25,0 cm
- 13.0651 28,0 cm **13.0651SC**

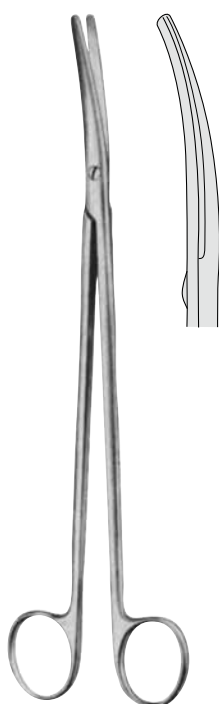
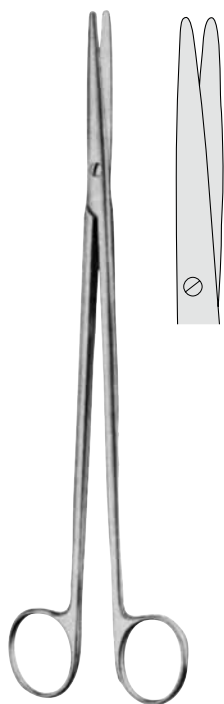

METZENBAUM-FINO

- 13.0660 14,5 cm **13.0660SC**
- 13.0662 18,0 cm **13.0662SC**
- 13.0664 20,0 cm **13.0664SC**
- 13.0666 23,0 cm **13.0666SC**

METZENBAUM-FINO

- 13.0661 14,5 cm **13.0661SC**
- 13.0663 18,0 cm **13.0663SC**
- 13.0665 20,0 cm **13.0665SC**
- 13.0667 23,0 cm **13.0667SC**

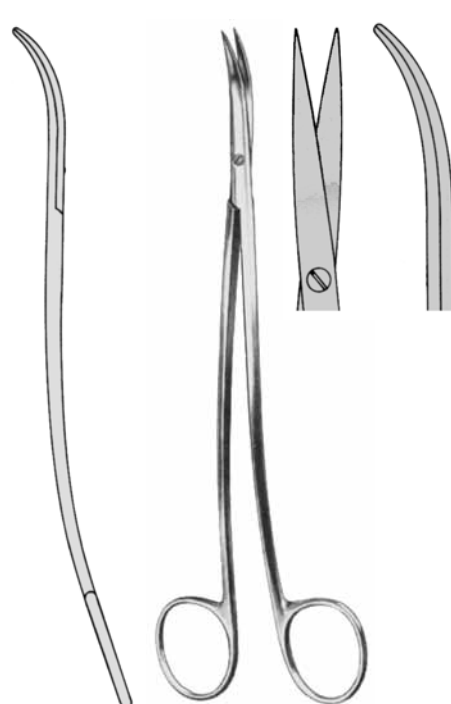
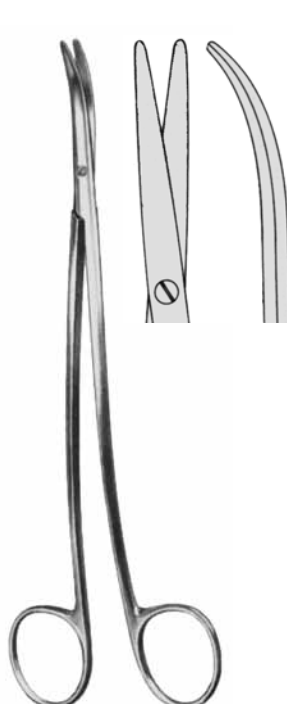
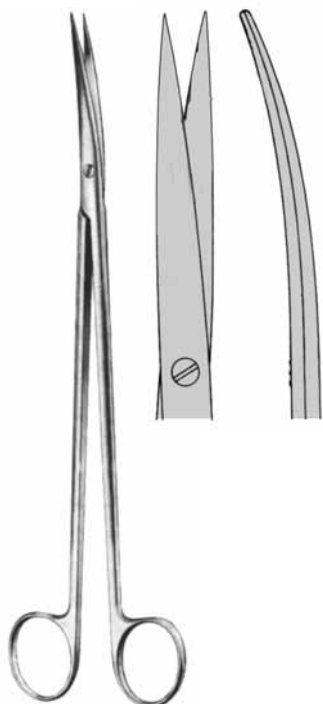
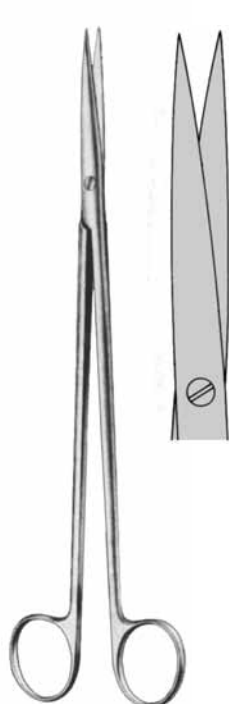

METZENBAUM-FINO

- 13.0670 14,5 cm
- 13.0672 18,0 cm
- 13.0674 20,0 cm
- 13.0676 23,0 cm

METZENBAUM-FINO

- 13.0671 14,5 cm
- 13.0673 18,0 cm
- 13.0675 20,0 cm
- 13.0677 23,0 cm

METZENBAUM-FINO

- 13.0683 18,0 cm
- 13.0685 20,0 cm
- 13.0687 23,0 cm

METZENBAUM-FINO

- 13.0693 18,0 cm
- 13.0695 20,0 cm
- 13.0697 23,0 cm



IRIS
13.5000
 11,5 cm

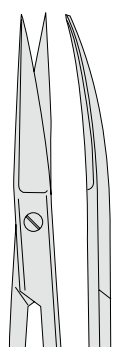

IRIS
13.5001
 11,5 cm



IRIS
13.5007
 11,5 cm



STRABISMUS
13.5010
 11,5 cm



STRABISMUS
13.5011
 11,5 cm



GOLDMAN-FOX
13.5020
 13 cm

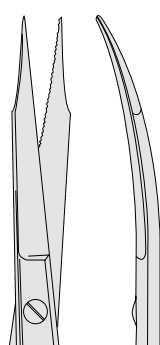

GOLDMAN-FOX
13.5021
 13 cm



BABY-LEXER
13.5030
 10 cm



BABY-LEXER
13.5031
 10 cm



RAGNELL
13.5041
 11,5 cm

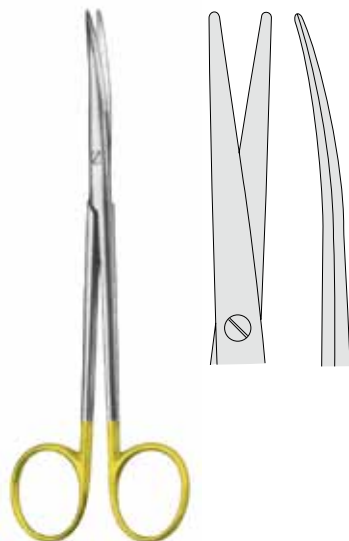

TOENNIS-ADSON
13.5291 17,5 cm



METZENBAUM



13.5298
11,5 cm

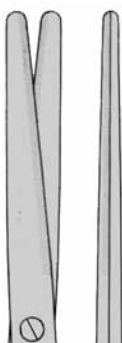

13.5300
14,5 cm



METZENBAUM

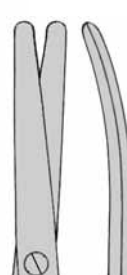

13.5299
11,5 cm

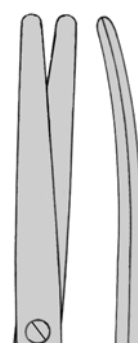

13.5301
14,5 cm

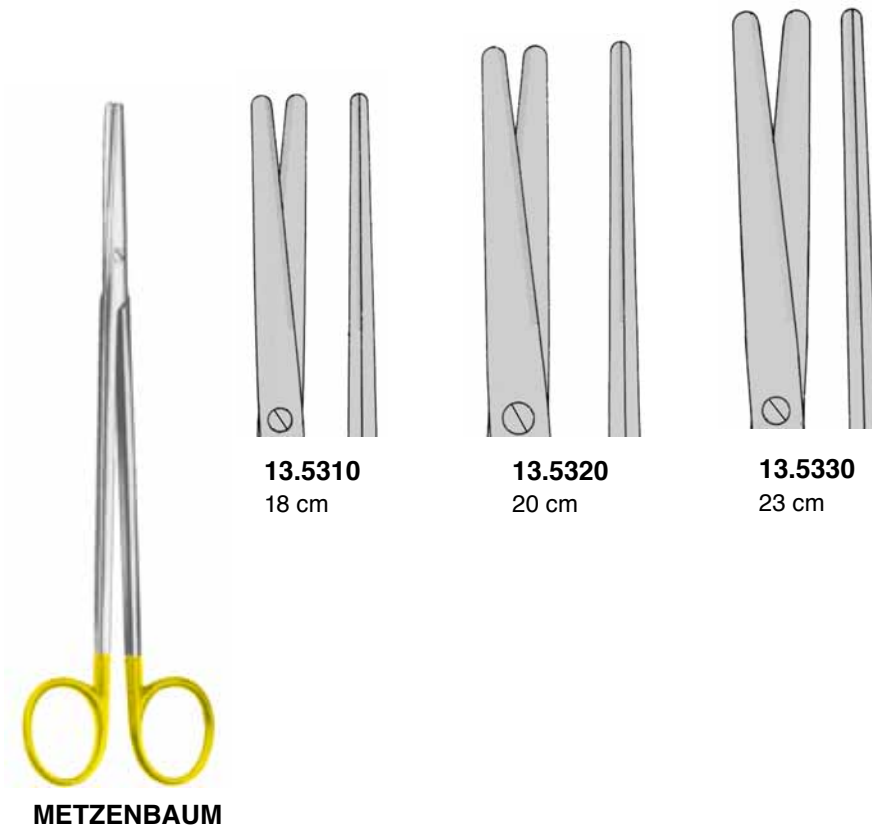

13.5310
18 cm

13.5320
20 cm

13.5330
23 cm

METZENBAUM

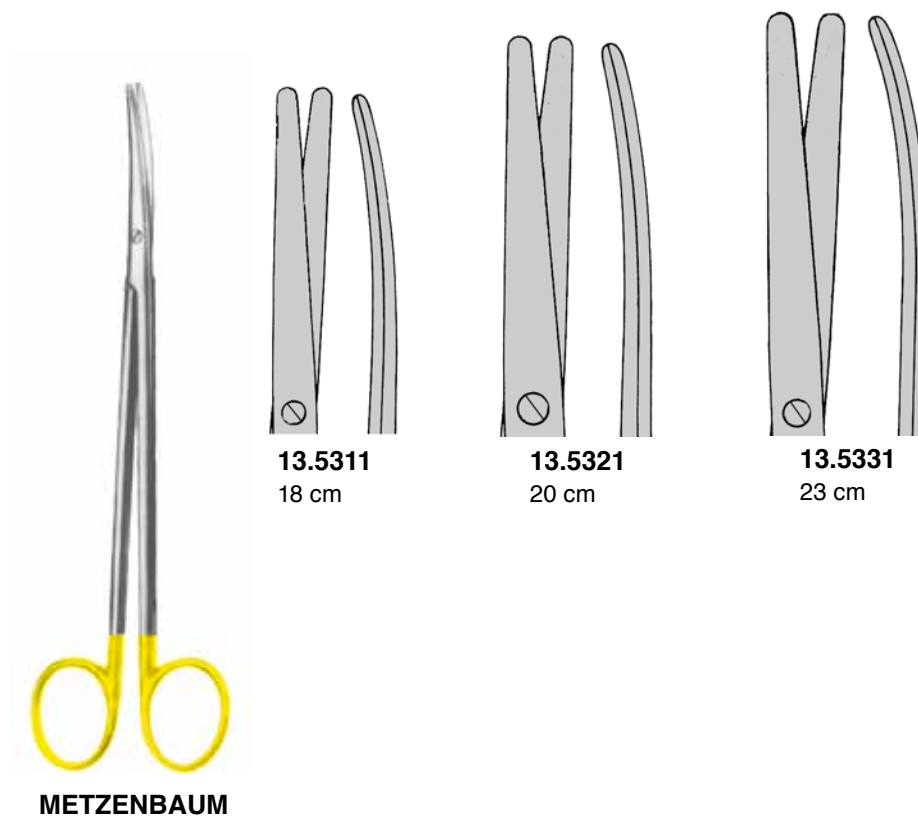

13.5311
18 cm

13.5321
20 cm

13.5331
23 cm

METZENBAUM



METZENBAUM-FINO

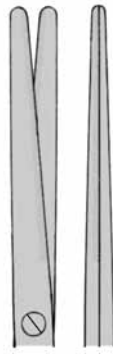

13.5304
14,5 cm

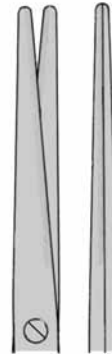

13.5314
18 cm



13.5324
20 cm



METZENBAUM-FINO

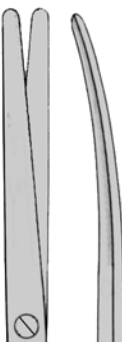

13.5305
14,5 cm

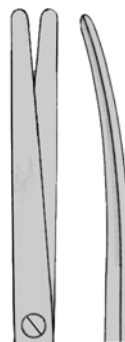

13.5315
18 cm

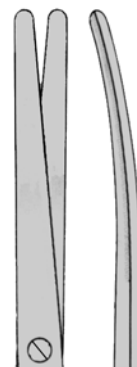

13.5325
20 cm



METZENBAUM X-FINO

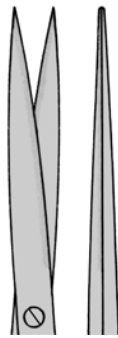

13.5308
14,5 cm

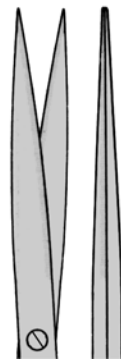

13.5318
18 cm



13.5328
20 cm



METZENBAUM X-FINO

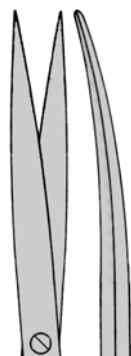

13.5309
14,5 cm

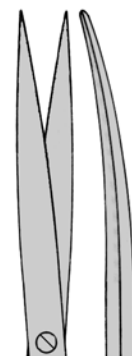

13.5319
18 cm

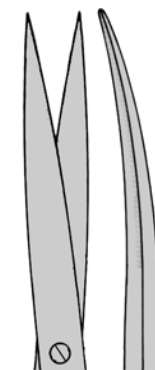

13.5329
20 cm

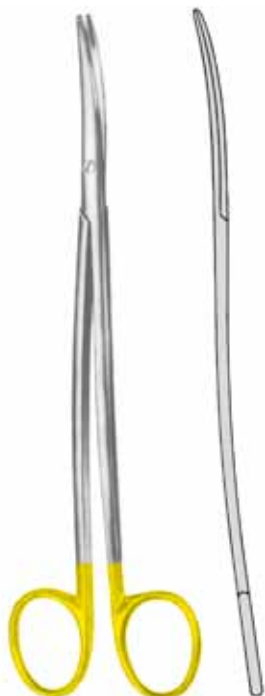

METZENBAUM-FINO

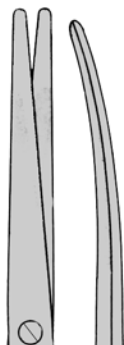

13.5313
18 cm

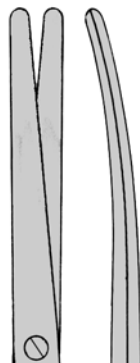

13.5323
20 cm

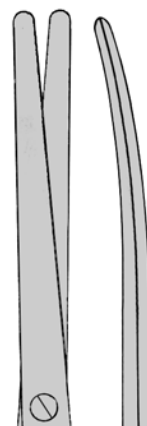

13.5333
23 cm

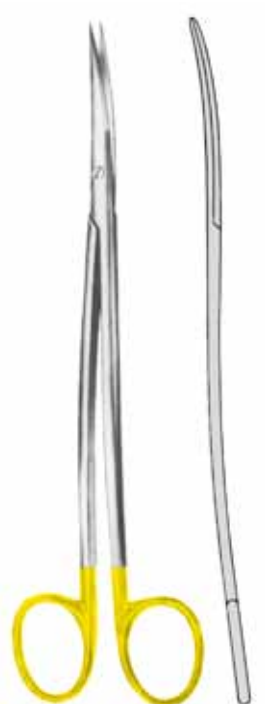

METZENBAUM-FINO

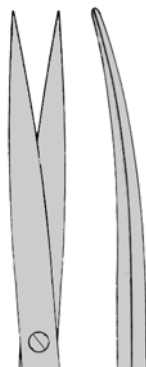

13.5317
18 cm

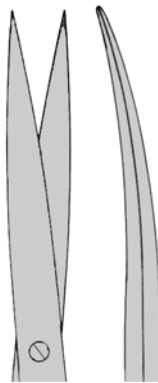

13.5327
20 cm



13.5337
23 cm

PINZETTEN
FORCEPS
PINCES
PINZAS
PINZE



TITANIUM



GRAEFE
 14.0010 10 cm



GRAEFE
 14.0011 10 cm

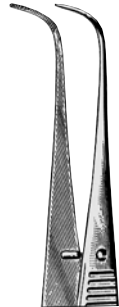

GRAEFE
 14.0013 10 cm



GRAEFE-SELECT
 10 cm



30.2000
 0,8 mm



30.2001
 0,8 mm



30.2003
 0,8 mm



30.2009
 0,8 mm



30.2000 T
 0,8 mm



30.2001T
 0,8 mm



30.2003T
 0,8 mm



GRAEFE-SELECT
 10 cm



30.2004
 0,5 mm



30.2005
 0,5 mm



30.2007
 0,5 mm



GRAEFE
14.0510
10 cm 1x2



14.0511
10 cm 1x2

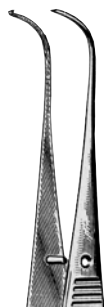

14.0513
10 cm 1x2



GRAEFE-SELECT
10 cm



30.2010
0,8 mm
1x2



30.2011
0,8 mm
1x2



30.2013
0,8 mm
1x2



GRAEFE-SELECT
10 cm



30.2014
0,5 mm
1x2



30.2015
0,5 mm
1x2



30.2017
0,5 mm
1x2



MIKRO
15.5 cm



14.0780
0,6 mm



14.0782
0,8 mm



14.0784
1,0 mm

Uhrmacher-Pinzetten / Jeweller Type Forceps / Pincès d'horloger
 /Pinzas de relojero / Pinze de orologiaio



JUWELIER #1
 14.1600 11,5 cm

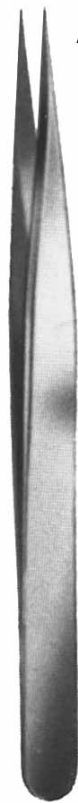

JUWELIER #3
 14.1602 11,5 cm



JUWELIER #3C
 14.1603 10,5 cm

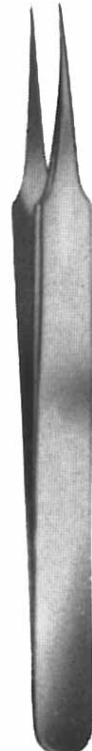

JUWELIER #4
 14.1604 11 cm



JUWELIER #5
 14.1605 11 cm



JUWELIER #7
 14.1607 11,5 cm



MIKRO
 15.5 cm



14.0380
 0,6 mm



14.0382
 0,8 mm



14.0384
 1,0 mm



PRO-MED Select
 14.1614 11 cm



PRO-MED Select
 14.1617 11.5 cm



ADSON
 14.0026 12 cm



ADSON-MICRO
 14.0028 12 cm



ADSON-MICRO
 14.0030 12 cm
 14.0032 15 cm

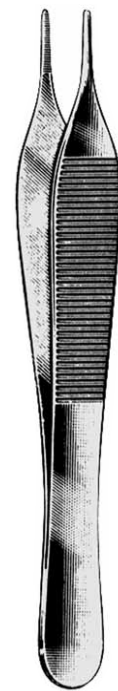
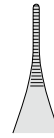

ADSON
 14.0040 12 cm
 14.0042 15 cm



12 cm

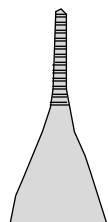

EWALD
 14.0049

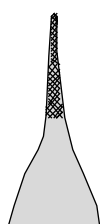

ADSON
 "Criss-Cross"
 14.0050



ADSON-DEBAKEY
 14.0546 12,5 cm
 14.0547 15,0 cm

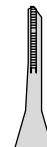



ADSON
 14.0526
 12 cm 1x2



ADSON-SELECT-MICRO
 14.0527
 12 cm 1x2



ADSON-MICRO
 14.0528
 12 cm 1x2



ADSON-MICRO
 14.0530 12 cm
 14.0532 15 cm

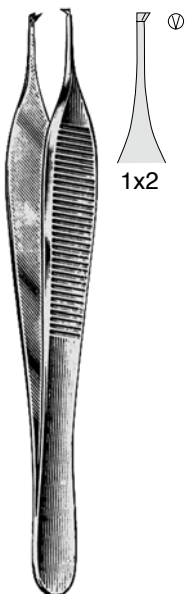

ADSON
 14.0540 12 cm
 14.0542 15 cm

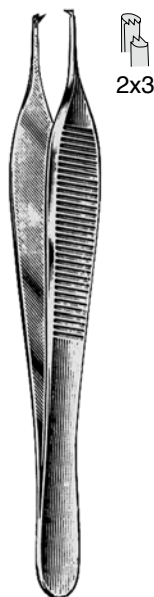

ADSON
 14.0541 12 cm 2x3

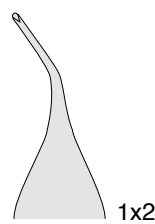

ADSON
 14.0543 12 cm 45° 1x2
 14.0545 15 cm 45° 1x2

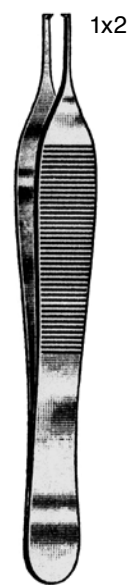

EWALD
 14.0549 12 cm



ADSON-GRAEFE
 14.0548 12 cm

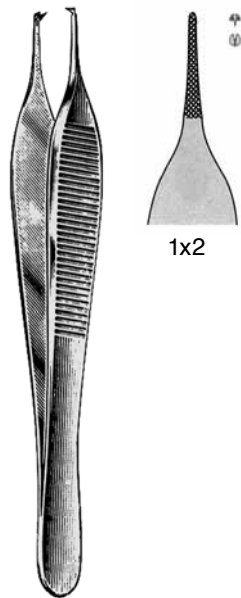

ADSON
 "Criss-Cross"
 14.0550 12 cm



ADSON
 14.0554 18 cm

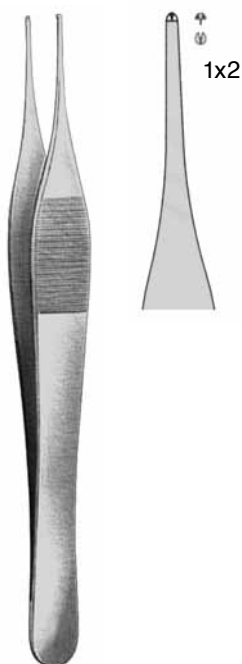

JEFFERSON
 14.0556 18 cm



SEMKEN
 14.0560 12 cm
 14.0562 15 cm

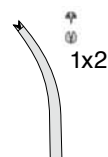

SEMKEN
 14.0561 12 cm
 14.0563 15 cm

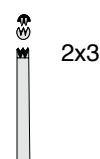

SEMKEN
 14.0566 12 cm



GILLIES
 14.0570 15 cm



DRESSING-FINO

- 14.0100 10,5 cm
- 14.0101 11,5 cm
- 14.0102 13,0 cm
- 14.0103 14,5 cm

- 14.0104 15,0 cm
- 14.0105 16,0 cm
- 14.0107 18,0 cm
- 14.0108 20,0 cm

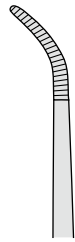

DRESSING-FINO

- 14.0110 10,5 cm
- 14.0111 11,5 cm
- 14.0112 13,0 cm
- 14.0113 14,5 cm

- 14.0114 15,0 cm
- 14.0115 16,0 cm
- 14.0116 18,0 cm
- 14.0117 20,0 cm



DRESSING

- 14.0120 10,5 cm
- 14.0121 11,5 cm
- 14.0122 13,0 cm
- 14.0123 14,5 cm
- 14.0124 15,0 cm
- 14.0125 16,0 cm
- 14.0127 18,0 cm
- 14.0128 20 cm

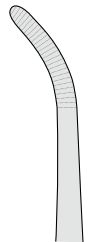

DRESSING

- 14.0151 11,5 cm
- 14.0152 13,0 cm
- 14.0153 14,5 cm

- 14.0154 15,0 cm
- 14.0155 16,0 cm
- 14.0157 18,0 cm
- 14.0158 20,0 cm



DRESSING-USA

- 14.0181 11,5 cm
- 14.0182 13,0 cm
- 14.0183 14,5 cm
- 14.0184 15,5 cm
- 14.0187 18,0 cm
- 14.0188 20,0 cm



STILLE

- 14.0202 13 cm
- 14.0204 15 cm
- 14.0207 17 cm
- 14.0220 20 cm



BLANK

- 14.0142 13,0 cm
- 14.0143 14,5 cm
- 14.0144 16,0 cm



BROPHY

- 14.0300 20 cm



BROPHY

- 14.0301 20 cm



TISSUE-FINO

14.0600	10,5 cm	1x2
14.0601	11,5 cm	1x2
14.0602	13,0 cm	1x2
14.0603	14,5 cm	1x2
14.0604	15,0 cm	1x2
14.0605	16,0 cm	1x2
14.0607	18,0 cm	1x2
14.0608	20,0 cm	1x2

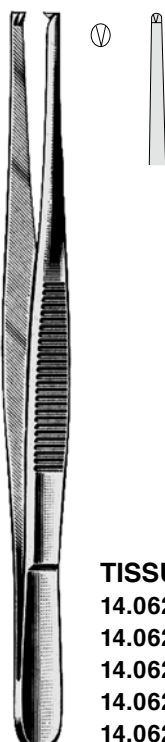

TISSUE

14.0620	10,5 cm	1x2
14.0621	11,5 cm	1x2
14.0622	13,0 cm	1x2
14.0623	14,5 cm	1x2
14.0624	15,0 cm	1x2
14.0625	16,0 cm	1x2
14.0627	18,0 cm	1x2
14.0628	20,0 cm	1x2



TISSUE

14.0653	14,0 cm	1x2
14.0657	18,0 cm	1x2

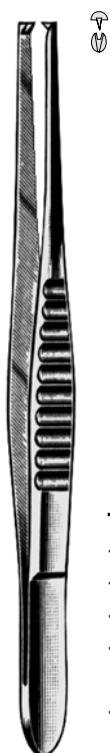

TISSUE-USA

14.0681	12,0 cm	1x2
14.0682	13,0 cm	1x2
14.0683	14,5 cm	1x2
14.0684	15,5 cm	1x2
14.0687	18,0 cm	1x2



TISSUE

14.0701	11,5 cm	2x3
14.0702	13,0 cm	2x3
14.0703	14,5 cm	2x3
14.0704	15,0 cm	2x3
14.0705	16,0 cm	2x3
14.0707	18,0 cm	2x3
14.0708	20,0 cm	2x3

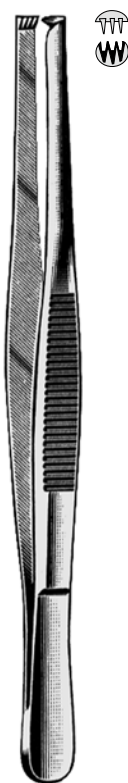

TISSUE

14.0722	13,0 cm	3x4
14.0723	14,5 cm	3x4
14.0724	15,0 cm	3x4
14.0725	16,0 cm	3x4
14.0727	18,0 cm	3x4
14.0728	20,0 cm	3x4



CUSHING
14.0310 18 cm



CUSHING
14.0311 18 cm



GERALD
14.0320 18 cm

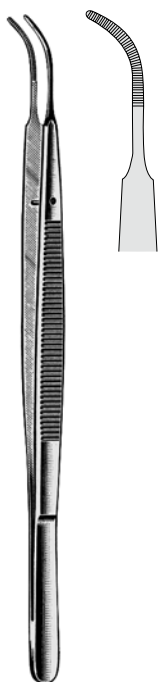

GERALD
14.0321 18 cm



GERALD
14.0325 18 cm

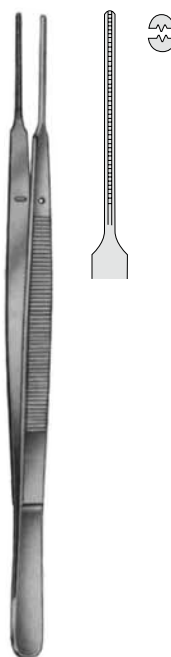

DEBAKEY-GERALD
14.0328 18 cm



POTTS-SMITH
14.0350 18 cm
14.0352 21 cm
14.0354 25 cm



BROPHY
14.0800 20 cm 1x2



BROPHY
14.0801 20 cm 1x2



GERALD
14.0820 18 cm 1x2



GERALD
14.0821 18 cm 1x2



GERALD
14.0825 18 cm 1x2



TAYLOR
14.0360 18 cm

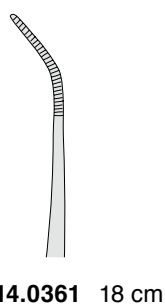

14.0361 18 cm



TAYLOR-CUSHING
14.0362 18 cm



TAYLOR-CUSHING
14.0365 18 cm



WAUGH
14.0368 15 cm
14.0370 20 cm

TITANIUM



POTTS-SMITH

14.0851 18 cm 1x2

14.0853 21 cm 1x2

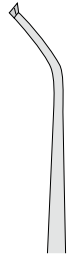

TAYLOR

14.0860 18 cm



TAYLOR

14.0861 18 cm

POTTS-SMITH

14.0850 18 cm 1x2

14.0852 21 cm 1x2

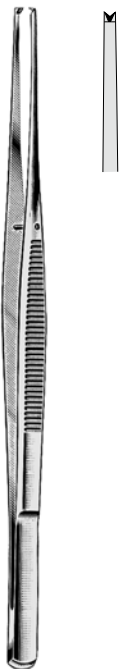

TAYLOR-CUSHING

14.0862 18 cm



TAYLOR-CUSHING

14.0865 18 cm



DEBAKEY

14.1060 15 cm /1 mm

14.1060T 15 cm /1 mm

14.1062 20 cm/1 mm

14.1062T 20 cm/1 mm



DEBAKEY

14.1000 15 cm / 1,5 mm
14.1002 20 cm / 1,5 mm



DEBAKEY

14.1010 15 cm / 2 mm
14.1010T 15 cm / 2 mm
14.1012 20 cm / 2 mm
14.1012T 20 cm / 2 mm



DEBAKEY

14.1021 16 cm / 2 mm
14.1021T 16 cm / 2 mm
14.1023 20 cm / 2 mm
14.1023T 20 cm / 2 mm



DEBAKEY

14.1030 16 cm / 2,7 mm
14.1030T 16 cm / 2,7 mm
14.1032 20 cm / 2,7 mm
14.1032T 20 cm / 2,7 mm



14.1070
15 cm 4 mm



14.1072
24 cm 8 mm

GLASSMANN



14.2001 12 cm
 glatt / smooth
 lisse / lisa / liscio



ADSON
14.2005 12 cm 1x2
14.2007 15 cm 1x2

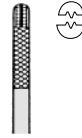

SEMKEN
14.2010 15 cm



CUSHING
14.2020 18 cm



CUSHING
14.2021 18 cm



CUSHING
14.2023 19 cm



POTTS-SMITH
14.2049 15 cm
14.2050 18 cm



WANGENSTEEN
14.2070 15 cm



1.8 mm

DRESSING
14.2103 14,5 cm
14.2105 16,0 cm
14.2107 18,0 cm
14.2108 20,0 cm

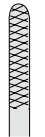

2.7 mm

DRESSING
14.2122 13,0 cm
14.2123 14,5 cm
14.2125 16,0 cm
14.2127 18,0 cm
14.2128 20,0 cm



MC INDOE
 14.2170 15 cm



DEBAKEY
 14.2200
 15 cm / 1,5 mm
 14.2202
 19 cm / 1,5 mm



DEBAKEY
 14.2210
 15 cm / 2 mm
 14.2212
 19 cm / 2 mm

DEBAKEY

- 14.2220
15 cm / 2,7 mm
- 14.2222
19 cm / 2,7 mm
- 14.2224
24 cm / 2,7 mm

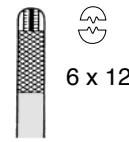

DEBAKEY
 14.2230
 15 cm / 3,5 mm
 14.2232
 19 cm / 3,5 mm



DEBAKEY
 14.2240
 15 cm / 2 mm
 14.2242
 19 cm / 2 mm



GERALD
 14.2320 18 cm



BONNEY
 14.2390 18 cm



GERALD
 14.2820 18 cm 1x2



GILLIES
 14.2570 15 cm 1x2



OEHLER

14.2623 14 cm
14.2625 16 cm
14.2627 18 cm
14.2628 20 cm



BONNEY

14.2890 18 cm 1x2



ADSON-BROWN

14.2900 12 cm 9x9

PRO-MED ist Ihnen behilflich bei der Zusammenstellung von Operationsbestecken für die verschiedensten Disziplinen. Fragen Sie nach unseren vorbereiteten OP-Bestecken.

For your convenience a wide variety of Suggested Operating Sets for most general and specialized procedures is available from **PRO-MED**. Please contact us or your local dealer.

PRO-MED vous propose de multiples compositions de boîtes opératoires multidisciplinaires. Demandez nos suggestions pour de nombreuses interventions.

PRO-MED le ayuda en componer varias cajas de instrumentos quirúrgicos. Pregunte por nuestro instrumental quirúrgico preparado.

Per la vostra comodità **PRO-MED** Vi aiuta nella raccolta di strumenti chirurgici per le varie discipline. Vi preghiamo di chiedere informazioni sui nostri set di strumenti chirurgici già preparati.

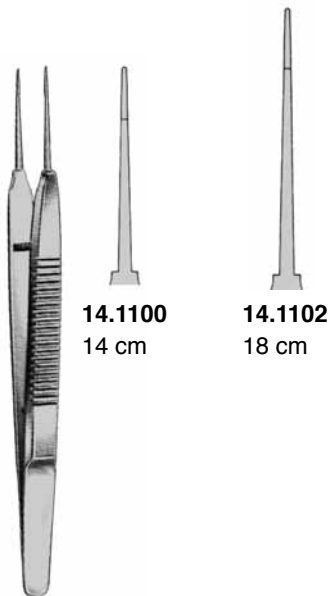

14.1100
14 cm

14.1102
18 cm

AUSTIN



VISE
14.1110
12 cm 0,3 mm



VISE
14.1112
13,5 cm 0,3 mm



VISE
14.1113
13,5 cm 0,3 mm

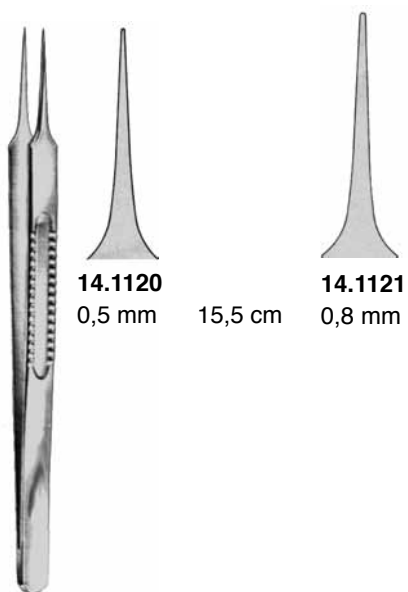

14.1120
0,5 mm 15,5 cm

14.1121
0,8 mm

LAZAR

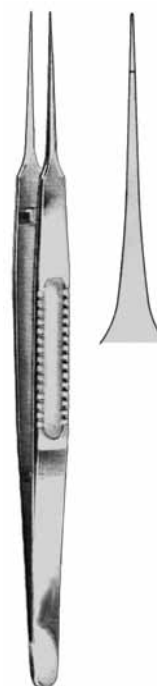

LAZAR
14.1122
18,5 cm 0,5 mm

ARTERIENKLEMMEN, PRÄPARIERKLEMMEN
HEMOSTATIC- AND DISSECTING FORCEPS
PINCES HEMOSTATIQUES ET A PREPARATION
PINZAS HEMOSTATICAS Y PARA PREPARACIONES
PINZE EMOSTATICHE E PER PREPARAZIONE

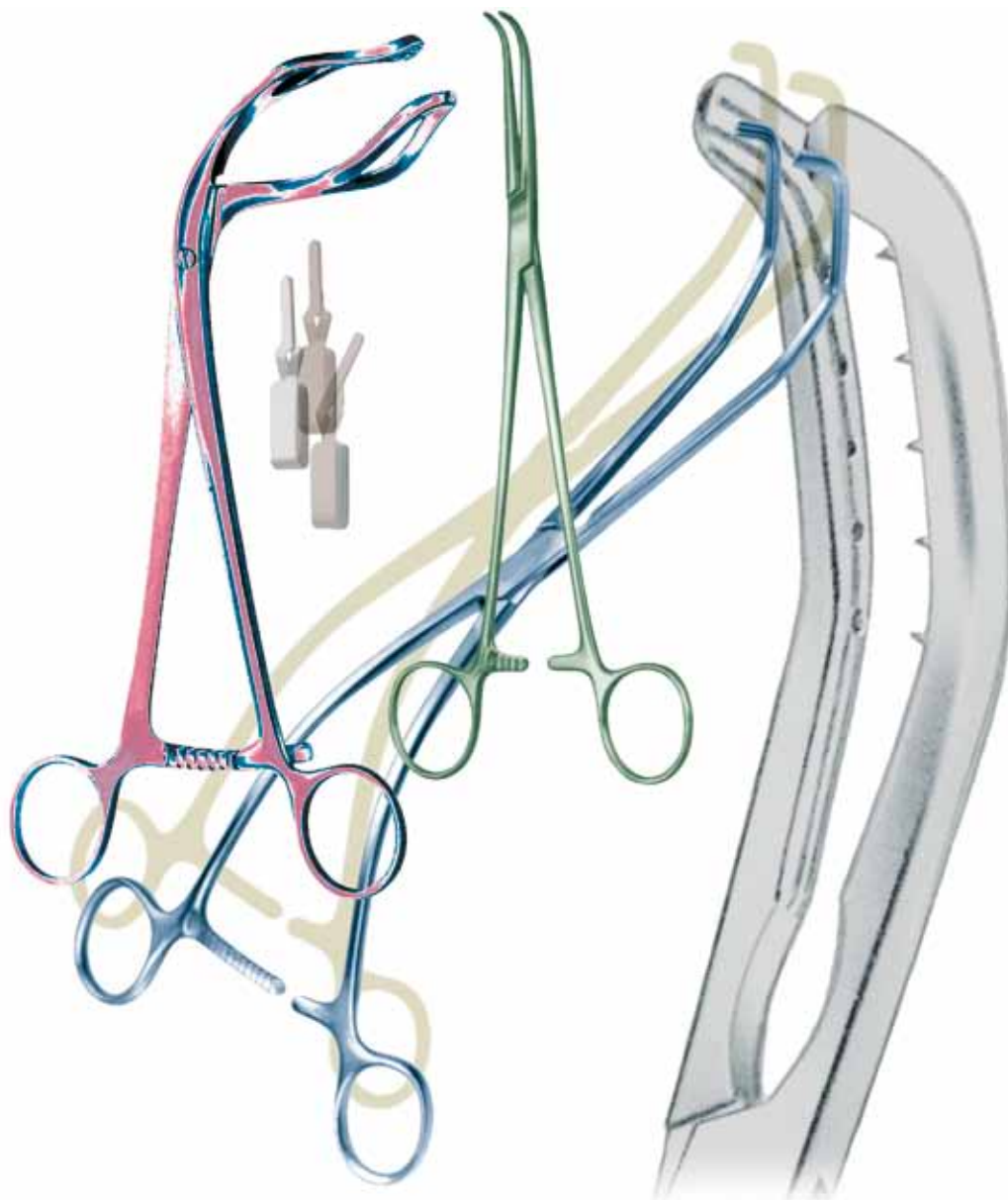

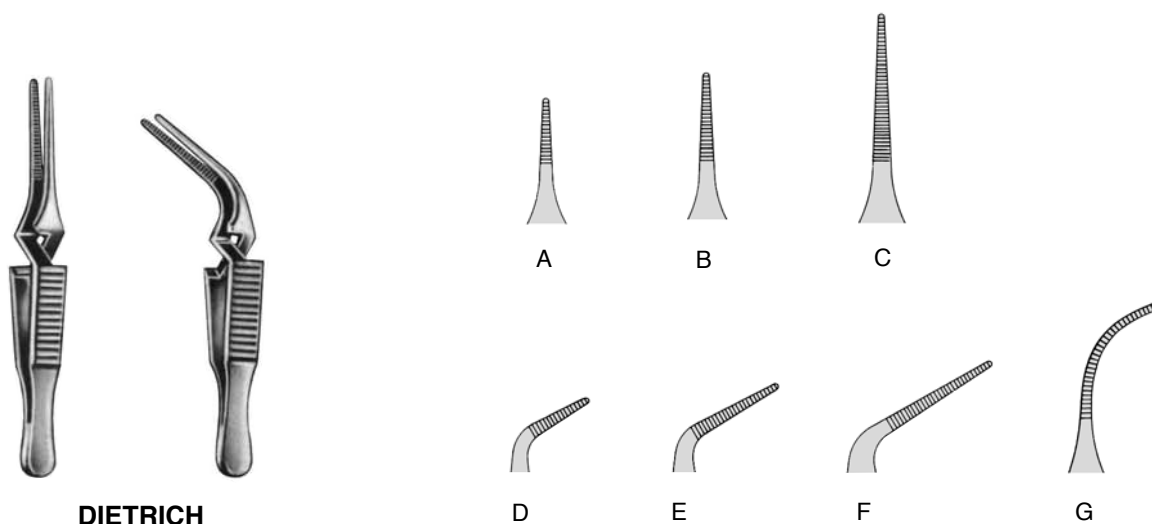

Artikel Item	Fig.	Gesamtlänge Overall length Longeur complet largo total Lunghezza total	Maullänge Jaw length longeur de mors largo de boca Lunghezza del morso	Gewicht Weight Poids Peso Peso	Schliessdruck Closing pressure Pression d'Occlusion Presión de cierre Pressione di chiusura
41.0030	A	50 mm	8 mm	3 g	80
41.0031	D	43 mm	8 mm	3 g	80
41.0032	B	53 mm	12 mm	3 g	80
41.0033	E	45 mm	12 mm	3 g	80
41.0034	C	60 mm	20 mm	3 g	80
41.0035	F	50 mm	20 mm	3 g	80
41.0037	G	54 mm	20 mm	3 g	80



CARREL
15.0098 8,5 cm



15.0100

HARTMANN
10 cm



15.0108
glattes Maul
smooth jaws
lisses
lisas
liscio



HARTMANN
15.0101 10 cm

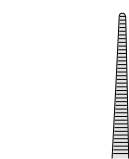

HARTMANN-MICRO
15.0102 10 cm



HARTMANN-MICRO
15.0103 10 cm



HARTMANN
15.0104 10 cm 1x2



HARTMANN
15.0105 10 cm 1x2



JACOBSON-MICRO
 15.0116 12,5 cm

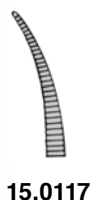

15.0117

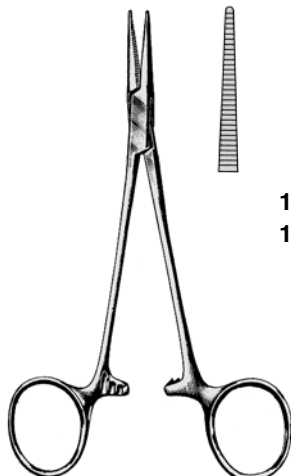

MOSQUITO
 15.0120 12,5 cm
 15.0120L 12,5 cm
 15.0124 14 cm

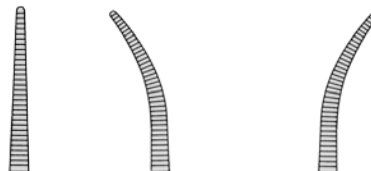

15.0121 12,5 cm
 15.0125 14 cm
 15.0121L

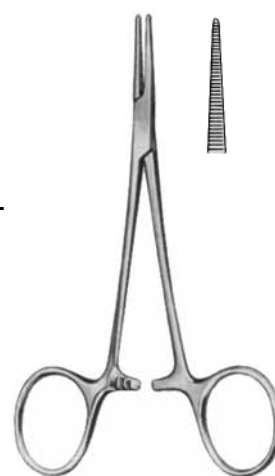

MICRO-MOSQUITO
 15.0122 12,5 cm



15.0123



MICRO-MOSQUITO
 15.0128 12 cm 1x2

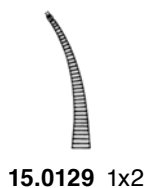

15.0129 1x2

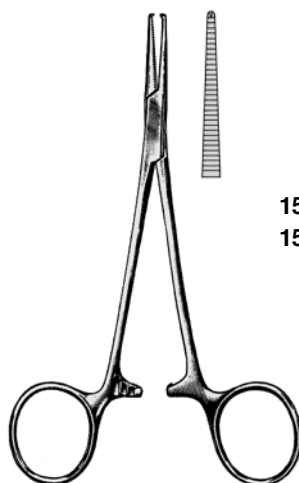

MOSQUITO
 15.0126 12,5 cm 1x2
 15.0136 14 cm 1x2

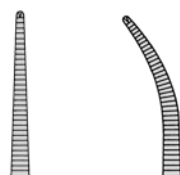

15.0127 12,5 cm 1x2
 15.0137 14 cm 1x2



MICRO-MOSQUITO
 15.0139 12,5 cm
 kreuzgerieft / cross-serrated
 rainures croisées
 estriada en forma de cruz
 striatura cruciforme

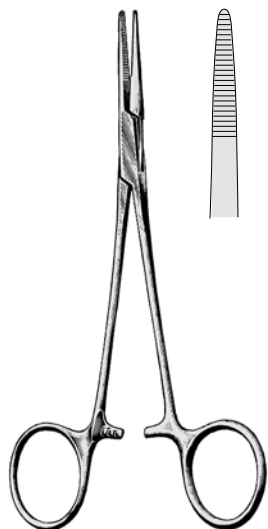

15.0131

PROVIDENCE-HOSPITAL
15.0130 14,5 cm

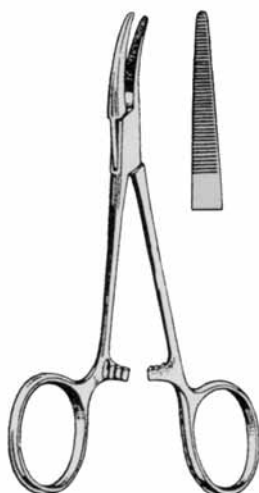

15.0181

DUNHILL
15.0180 12,5 cm



15.0201

KELLY
15.0200 14 cm



CRILE
15.0210 14 cm



15.0211



15.0212



15.0213



15.0214 1x2



15.0215 1x2

CRILE-BABY



DANDY-MOSQUITO
15.0218 12 cm



DANDY
14,5 cm

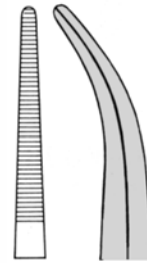

15.0220

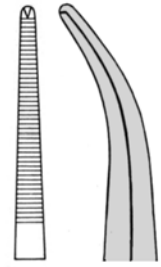

15.0222 1x2

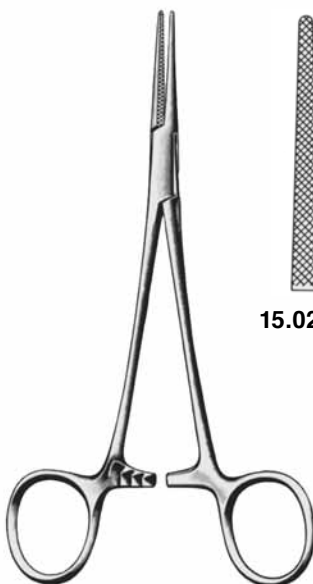

LOVELACE
15,5 cm



15.0224



15.0225 1x2

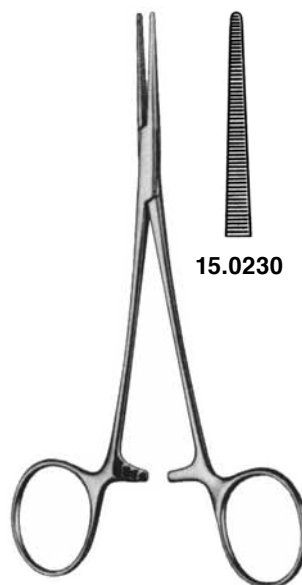

LERICHE
15 cm



15.0230



15.0231



15.0236 1x2



15.0237 1x2



15.0240

15.0241

RANKIN-KELLY
16 cm



15.0251

RANKIN-CRILE
15.0250 16 cm



15.0253
1x2

RANKIN-CRILE
15.0252 16 cm 1x2



COLLER-CRILE



15.0260
14 cm

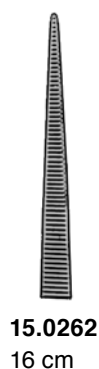

15.0262
16 cm



15.0261
14 cm



15.0263
16 cm

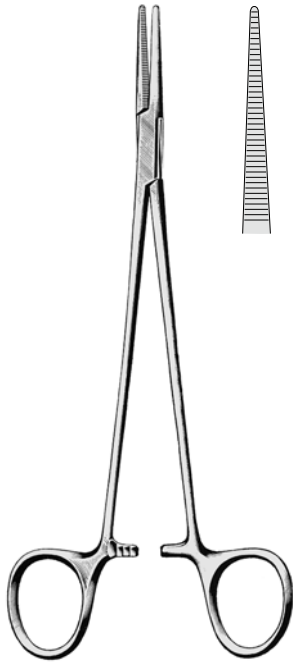

HALSTED

15.0300 18 cm
 15.0302 21 cm

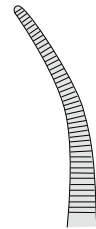

15.0301 18 cm
 15.0303 21 cm



15.0306 18 cm 1x2
 15.0308 21 cm 1x2

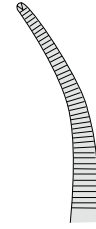

15.0307 18 cm 1x2
 15.0309 21 cm 1x2



ADSON-BABY
 15.0313 14 cm

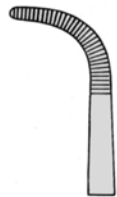

15.0315
 18 cm



ADSON
 15.0310 18,5 cm

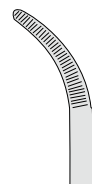

15.0311

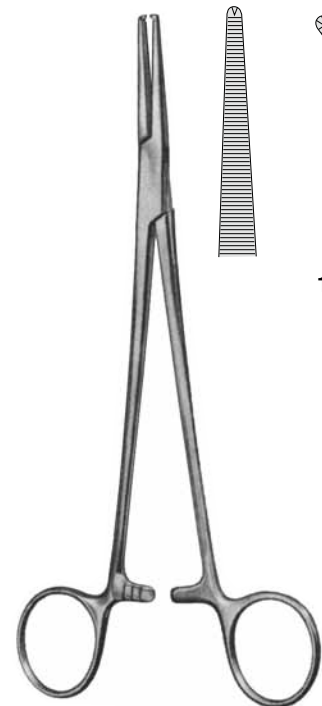

ADSON
 15.0316 18,5 cm 1x2

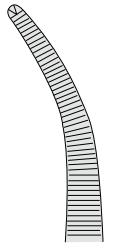

15.0317 1x2

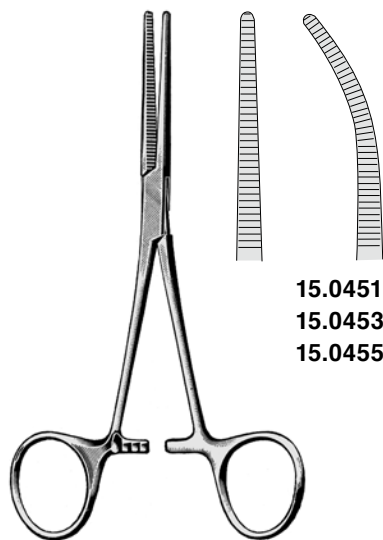

15.0451 13 cm
15.0453 14 cm
15.0455 16 cm

PEAN-FINO

15.0450 13 cm
15.0452 14 cm
15.0454 16 cm

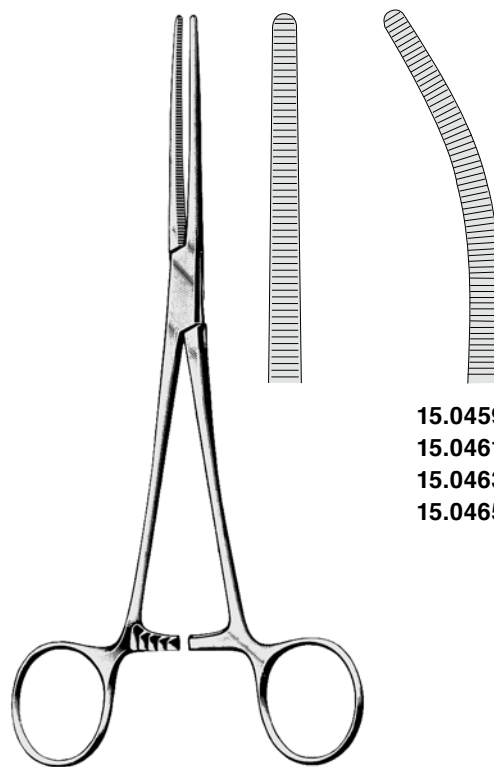

15.0459 13 cm
15.0461 14 cm
15.0463 16 cm
15.0465 18 cm

ROCHESTER-PEAN

15.0458 13 cm
15.0460 14 cm
15.0462 16 cm
15.0464 18 cm

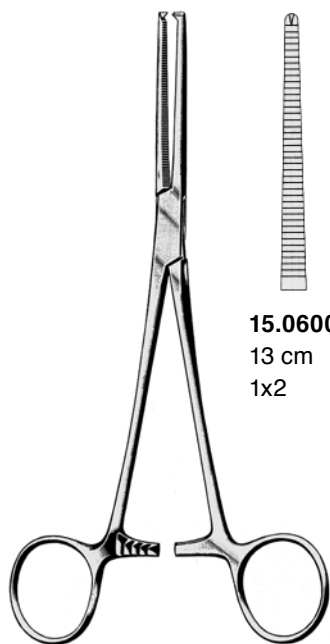

15.0600
13 cm
1x2

15.0601
13 cm
1x2

15.0602
14,5 cm
1x2

15.0603
14,5 cm
1x2

15.0604
16 cm
1x2

15.0605
16 cm
1x2

KOCHER

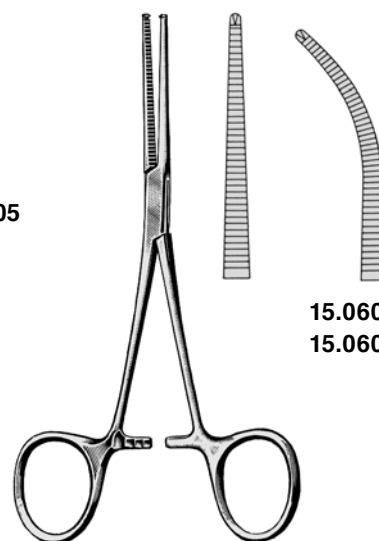

15.0607 14 cm
15.0609 16 cm

KOCHER-FINO

15.0606 14 cm
15.0608 16 cm

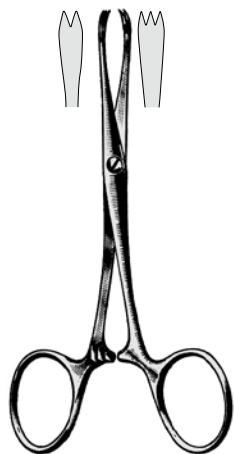

CHAPUT
15.1200 12 cm

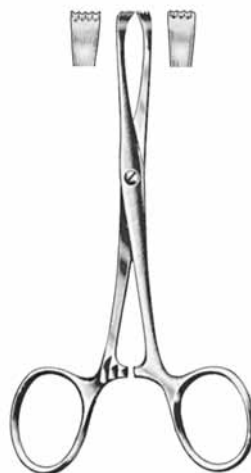

TUFFIER
15.1204 13 cm



PENNINGTON
15.1300 15 cm
15.1302 20 cm



ALLIS-BABY
48.0004 13 cm, 4 x 5
48.0006 14 cm, 4 x 5



ALLIS

48.0010
15 cm, 4 x 5

48.0011
15 cm, 5 x 6
48.0014
19 cm, 5 x 6

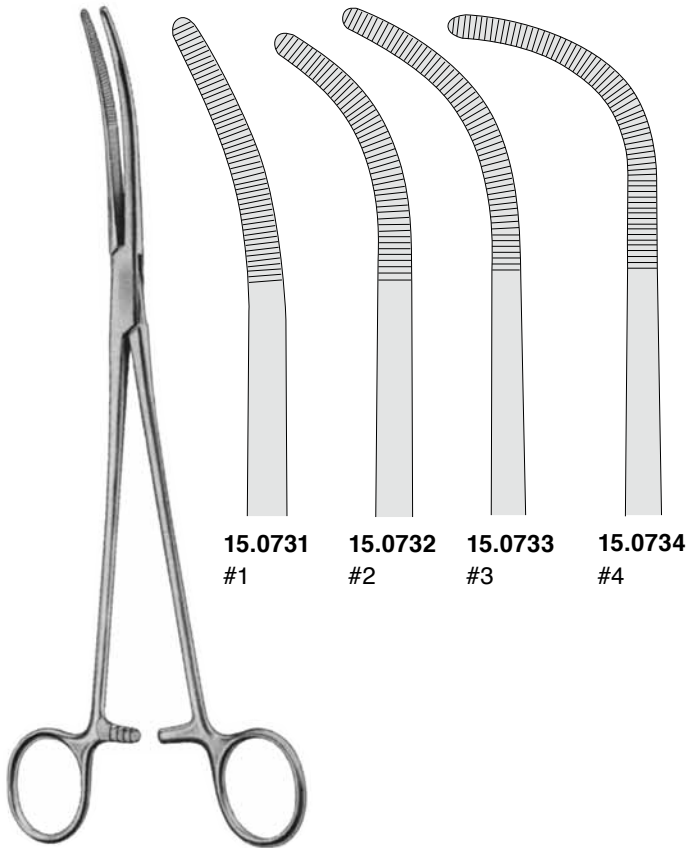

15.0731 #1
 15.0732 #2
 15.0733 #3
 15.0734 #4

RUMEL
 23 cm



15.0741 20 cm
 15.0743 24 cm
 15.0745 28 cm

KANTROWITZ

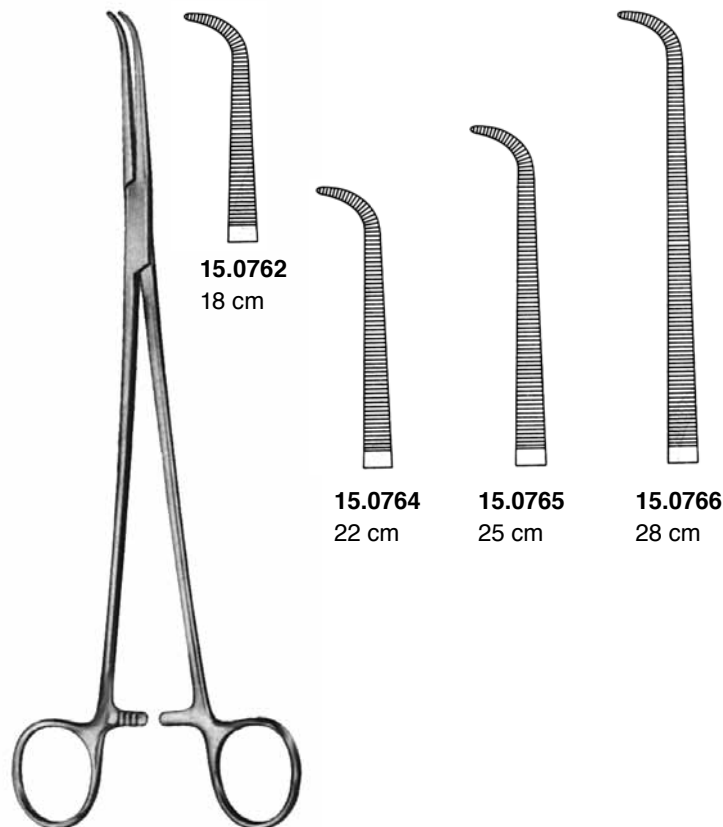

15.0762 18 cm

15.0764 22 cm

15.0765 25 cm

15.0766 28 cm

GEMINI-MINI

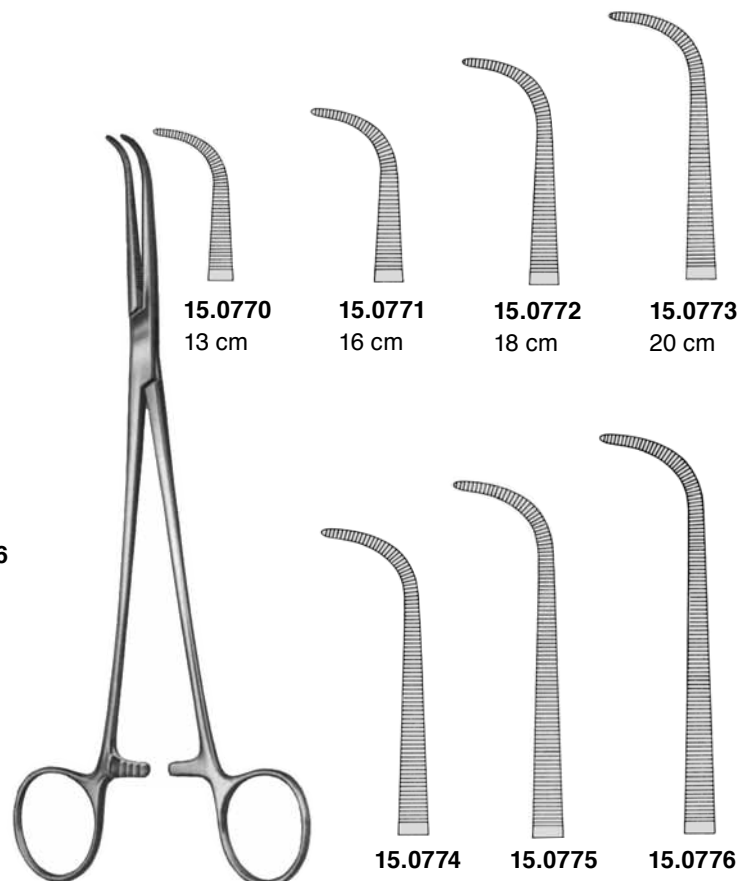

15.0770 13 cm

15.0771 16 cm

15.0772 18 cm

15.0773 20 cm

15.0774 23 cm

15.0775 25 cm

15.0776 28 cm

GEMINI



MIXTER-BABY
15.0801 14,5 cm



MIXTER-BABY
15.0803 18 cm

PRO-MED ist Ihnen behilflich bei der Zusammenstellung von Operationsbestecken für die verschiedensten Disziplinen. Fragen Sie nach unseren vorbereiteten OP-Bestecken.

For your convenience a wide variety of Suggested Operating Sets for most general and specialized procedures is available from **PRO-MED**. Please contact us or your local dealer.

PRO-MED vous propose de multiples compositions de boîtes opératoires multidisciplinaires. Demandez nos suggestions pour de nombreuses interventions.

PRO-MED le ayuda en componer varias cajas de instrumentos quirúrgicos. Pregunte por nuestro instrumental quirúrgico preparado.

Per la vostra comodità **PRO-MED** Vi aiuta nella raccolta di strumenti chirurgici per le varie discipline. Vi preghiamo di chiedere informazioni sui nostri set di strumenti chirurgici già preparati.

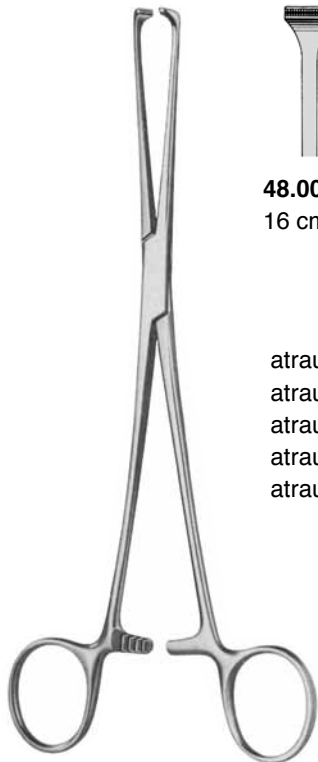

48.0020
16 cm

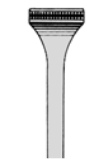

48.0024
20 cm

atraumatisch
 atraumatic
 atraumatique
 atraumática
 atraumatiche

ALLIS



ALLIS-ADAIR
48.0030 15,5 cm

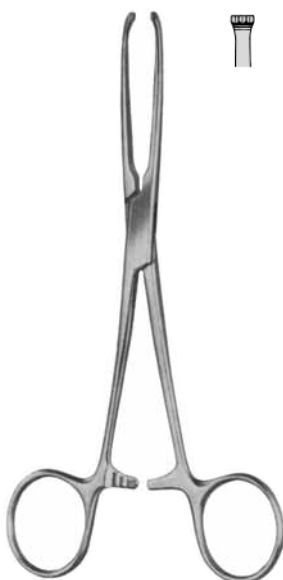

JUDD-ALLIS
48.0032 15 cm
48.0034 19 cm
3 x 4

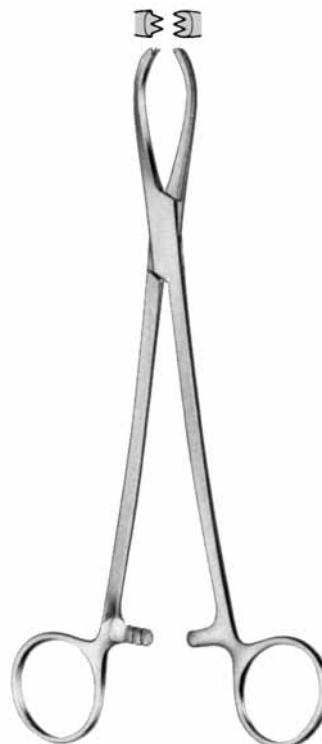

LITTLEWOOD
48.0035 19 cm
2 x 3



BOYS-ALLIS
48.0036 15 cm



BABCOCK

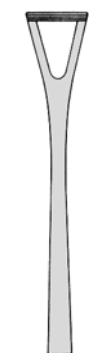

48.0062
16 cm

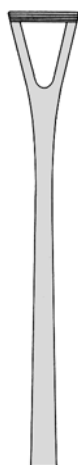

48.0064
18 cm



BABCOCK

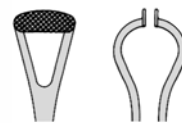

48.0072
16 cm

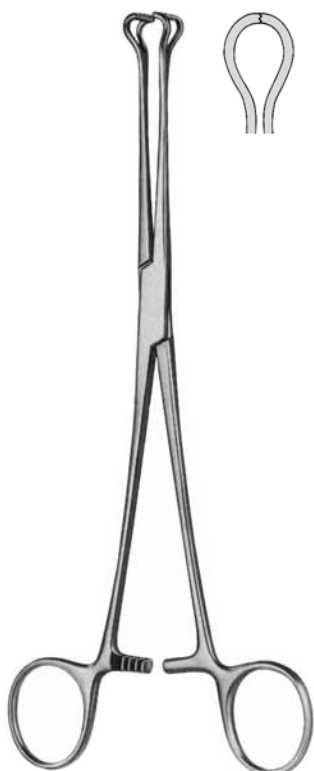

BABCOCK-DEBAKEY

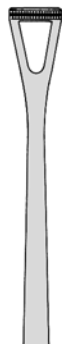

48.0082
16 cm

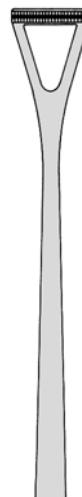

48.0086
20 cm



COLLIN
48.0089
14 cm



DUVAL



48.0090
18 cm / 14 mm
48.0092
20 cm / 14 mm

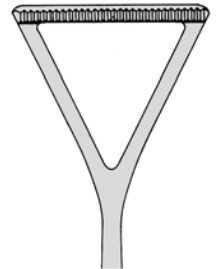

48.0094
20 cm / 25 mm
48.0098
23 cm / 25 mm



DUVAL



48.0099
20 cm / 15 mm

TUCH- UND SCHLAUCHKLEMMEN,
TUPFERZANGEN

TOWEL- AND TUBING CLAMPS,
DRESSING- AND SPONGE FORCEPS

PINCES A CHAMPS ET A TAMPONS,
PINCES PRESSE-TUBES

PINZAS DE CAMPO, PARA TUBOS
Y PARA TAMPONES

PINZE FISSATELI, PINZE SERRATUBI
PINZE PER TAMPONI





JONES
16.0010 5 cm
16.0012 9 cm



SCHAEDEL
16.0031 9 cm

mit Schlauchhalter
with tubeholder
avec clamp porte-tube
con porta-tubo
con porta-tubo



BACKHAUS
16.0100 9 cm
16.0102 11cm
16.0105 13 cm
16.0106 15 cm



BACKHAUS
16.0107 11 cm
16.0108 13 cm

für Papiertücher
for paper drapes
pour champs en papier
para paños de papel
per fazzoletti di carta

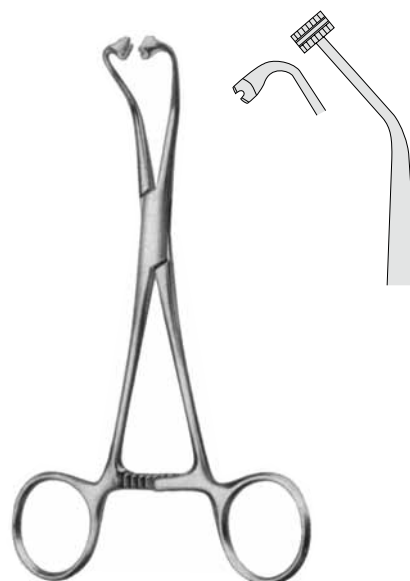

PEERS
16.0112 14,5 cm

für Papierabdeckung / for paper drapes / pour couverture en papier / para paños de papel / per copertura di carta

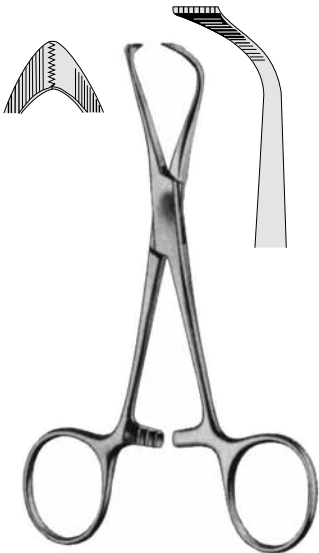

LORNA

16.0120 10 cm
16.0125 13 cm



BALL&SOCKET

16.0132 11 cm
16.0135 13 cm

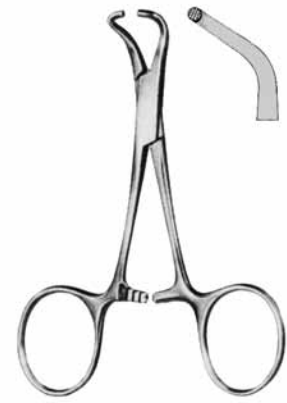

TOHOKU

16.0140 10 cm
16.0145 13 cm

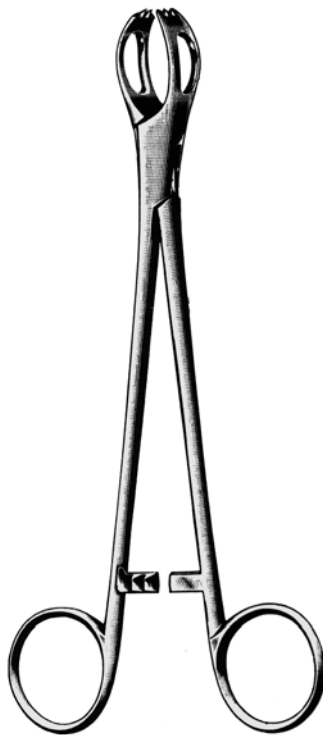

LANE

16.0160 15 cm
16.0164 20 cm



BERNHARD

16.0170 16,5 cm

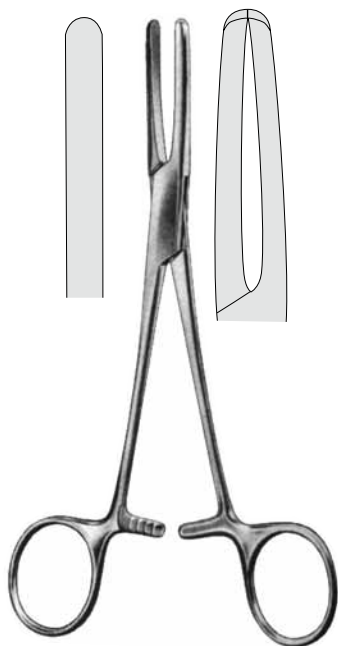

PRESBYTERIAN

16.0200 16 cm
 16.0202 18 cm

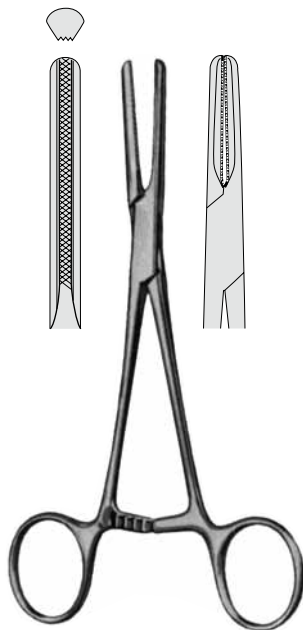

USA-MODEL

16.0220 16 cm
 16.0222 18 cm
 16.0224 20 cm

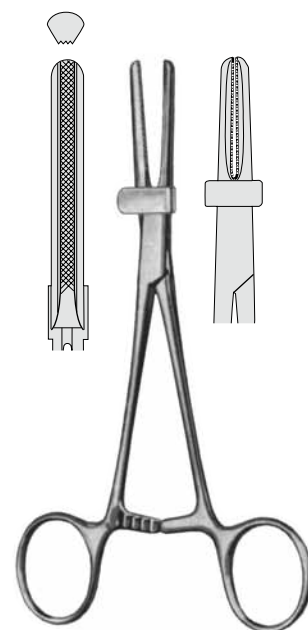

TUBING

16.0230 16 cm
 16.0232 18 cm
 16.0234 20 cm

Schlauchroller
 Tube milking clamps
 Pincés à traire les drains
 Rodillos para tubos
 Pinze pressa tubi con rulli



BROMPTON

16.0280 15,5 cm

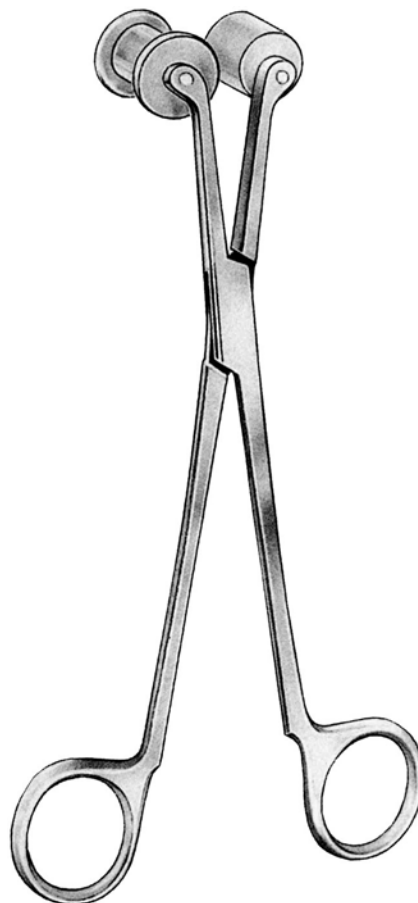

CUNNAR-HEY

16.0290 19 cm

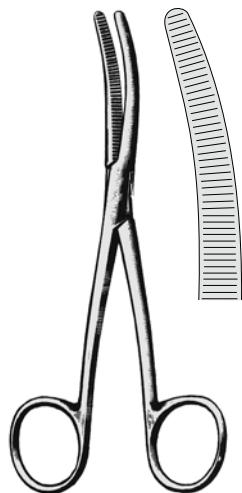

BRYANT
 16.0300 13 cm



LISTER-SINUS
 16.0360 13 cm
 16.0362 16 cm
 16.0364 18 cm

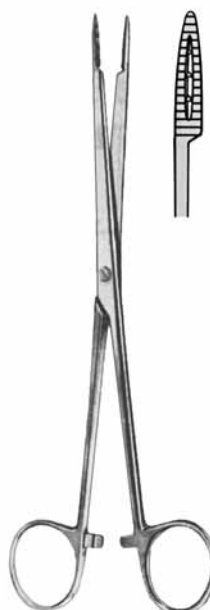

WALTON
 16.0370 17 cm



WALTON
 16.0371 17 cm

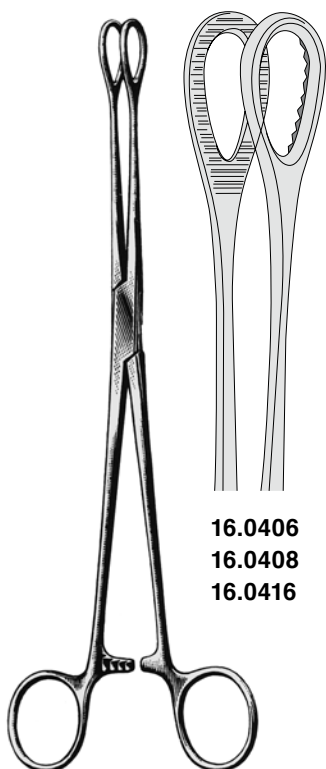

BALLENGER

16.0406
 16.0408
 16.0416

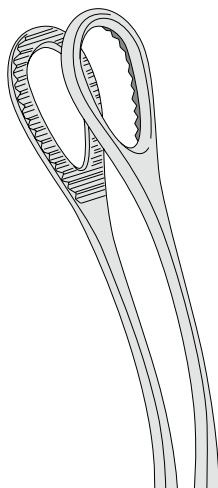

18 cm 16.0407
 20 cm 16.0409
 25 cm 16.0417



FOERSTER-DELIKAT
 25 cm

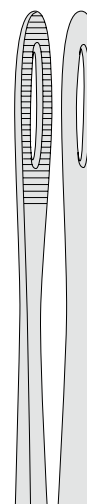

16.0418

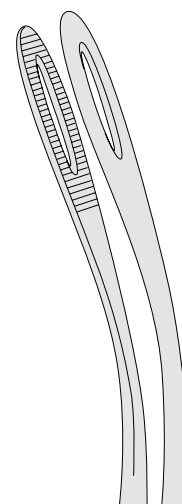

16.0419



PELKMANN

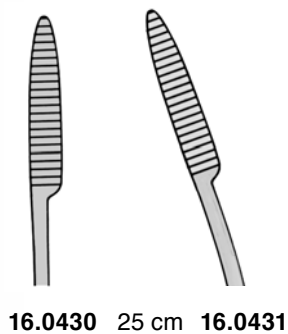

16.0430 25 cm **16.0431**

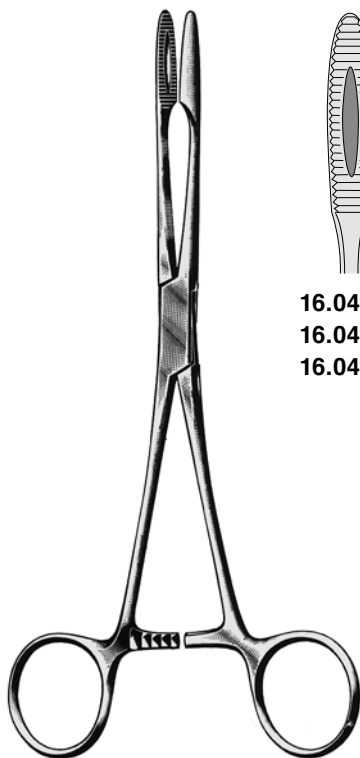

GROSS

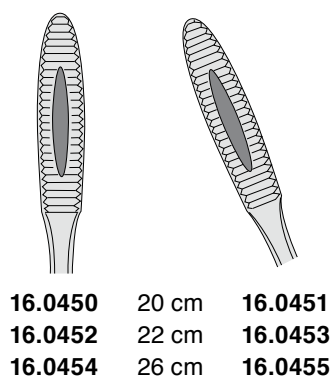

16.0450 20 cm **16.0451**
16.0452 22 cm **16.0453**
16.0454 26 cm **16.0455**



WUNDHAKEN
RETRACTORS
ECARTEURS
SEPARADORES
DIVARICATORI



17.0390 16,5 mm
 spitz
 sharp
 pointu
 agudo
 acuto



17.0391 16,5 mm
 stumpf
 blunt
 mousse
 romo
 smusso



17.0401 - 17.0414
 16 cm



17.0401



17.0411



17.0402



17.0412



17.0403



17.0413



17.0404
 spitz/sharp
 pointu /agudo
 acuto



17.0414
 stumpf/blunt
 mousse/romo
 smusso



17 cm



17.0471



17.0472



17.0473



17.0474

spitz
 sharp
 pointu
 agudo
 acuto



17.0476



17.0477



17.0478



17.0479

stumpf
 blunt
 mousse
 romo
 smusso



17.0500 14 x 5 mm



17.0501 17 x 5 mm

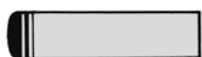

17.0502 25 x 6 mm

MOBERG
17 cm

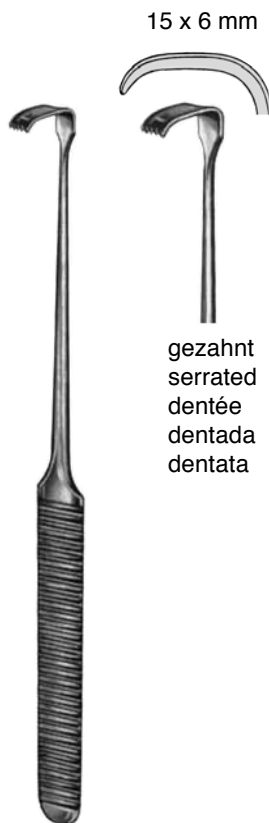

gezahnt
serrated
dentée
dentada
dentata

STRANDELL-STILLE
17.0510 19 cm

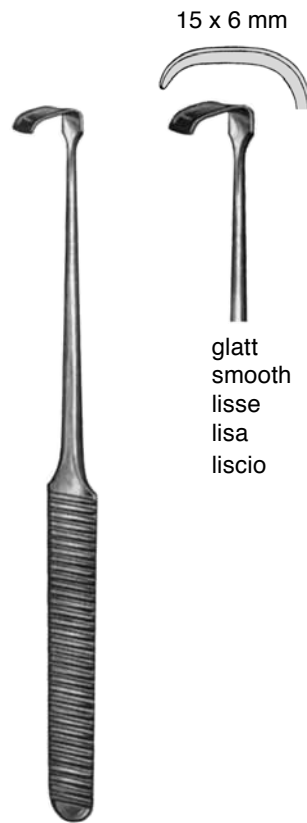

glatt
smooth
lisse
lisa
liscio

STRANDELL-STILLE
17.0512 19 cm



KLAPP
17,5 cm



17.0515



17.0516



KÖNIG
18 cm



17.0520
13 x 13 mm



17.0522
12 x 16 mm



CRILE
 17.0530 11 cm



LUER
 17.0535 11 cm

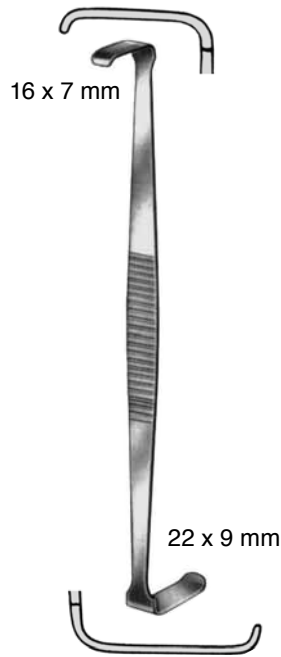

HOUSE
 17.0540 15 cm



RAGNELL-DAVIS
 17.0585 14 cm



SENN-MILLER
 17.0580, 17.0581
 16 cm



17.0580
 17.0588



17.0581
 17.0589

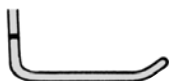

MATHIEU
 17.0588, 17.0589
 16 cm



SENN-MILLER-BABY
 15 cm



17.0582



17.0583



COPE
17.0566
18 cm



SENN-GREEN
15 cm



17.0560
10 x 6 mm



17.0562
20 x 6 mm



CUSHING
20 cm



17.0570
11 x 14 mm



17.0571
13 x 17 mm



LANGENBECK-MINI
16 cm



17.0590
10 x 6 mm



17.0591
17 x 5 mm



17.0592
20 x 6 mm



17.0593
22 x 8 mm

NAHT
SUTURE
SUTURE
SUTURA
SUTURA





CASTROVIEJO



18.0800
18.0802

14 cm
 18 cm



18.0810
18.0812

18.1800
18.1802

14 cm
 18 cm

18.1810
18.1812



18.0801
18.0803

14 cm
 18 cm



18.0811
18.0813

18.1801
18.1803

14 cm
 18 cm

18.1811
18.1813



CASTROVIEJO



BOYNTON
 18.1850 12 cm



ARRUGA
 16 cm



18.0860



18.0861



ARRUGA
 16 cm



18.1860



18.1861



DERF
18.0010 12 cm

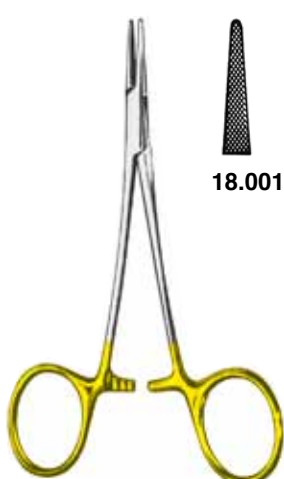

HALSEY-MICRO
12 cm



18.0018
glatt
smooth
lisse
lisa
liscio

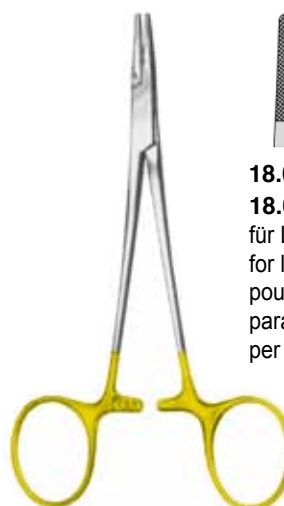

HALSEY
13 cm



18.0020
18.0020 L
für Linkshänder
for left-handers
pour gauchers
para zurdos
per mono sinistra



18.0025
glatt
smooth
lisse
lisa
liscio



WEBSTER
13 cm

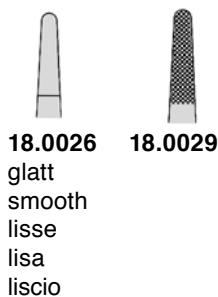

18.0026
glatt
smooth
lisse
lisa
liscio

18.0029



BAUMGARTNER
18.0030 14 cm



KILNER
13 cm

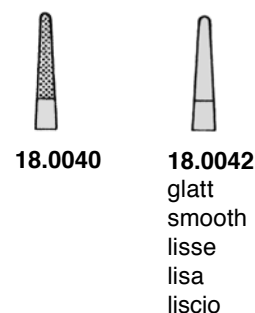

18.0040

18.0042
glatt
smooth
lisse
lisa
liscio



NEIVERT
 18.0050 12 cm



BABY-CRILE-WOOD
 18.0069 15 cm



CRILE-WOOD



18.0070
 15 cm



18.0071
 15 cm

18.0070L

15 cm
 für Linkshänder
 for left-handers
 pour gauchers
 para zurdos
 per mono sinistra



18.0072
 18 cm



18.0074
 20 cm

18.0072L
 18 cm

18.0074L
 20 cm

für Linkshänder / for left-handers / pour gauchers
 para zurdos / per mono sinistra



MAYO-HEGAR



18.0080
 16 cm



18.0082
 18 cm



18.0084
 20 cm

18.0080L
 16 cm

18.0082L
 18 cm

18.0084L
 20 cm

für Linkshänder / for left-handers / pour gauchers / para zurdos / per mono sinistra



DEBAKEY-SELECT



18.0100D
18 cm



18.0102D
20 cm



Diamantbeschichtete Spitzen
 Diamond coated tips
 Avec bouts de diamant
 Puntas con cascós de diamante
 Morsi con rivestimento di diamante



JULIAN
18.0113 20 cm



NEW ORLEANS
18.0120 18 cm



LANGENBECK

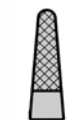

18.0242
18 cm



MATHIEU

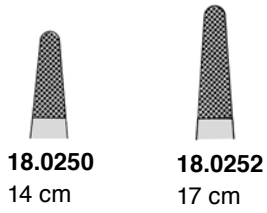

18.0250
14 cm

18.0252
17 cm



MATHIEU

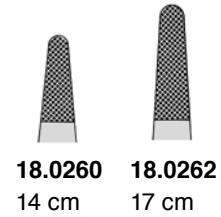

18.0260
14 cm

18.0262
17 cm

mit Innensperre
 with inside ratchet
 avec crémaillère interne
 con cremallera interior
 con cremagliera interna



MATHIEU-KOCHER

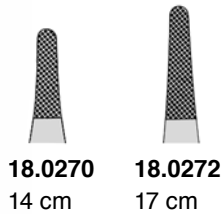

18.0270
14 cm

18.0272
17 cm

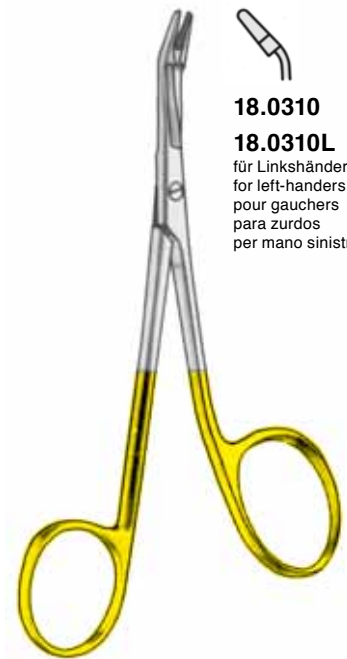

FOSTER-GILLIES



18.0310 12 cm

18.0310L 12 cm

für Linkshänder
 for left-handers
 pour gauchers
 para zurdos
 per mano sinistra



18.0320
15,5 cm

GILLIES-MINI



18.0322
16 cm

GILLIES



18.0330 12 cm
18.0330L 12 cm
 für Linkshänder
 for left-handers
 pour gauchers
 para zurdos
 per mano sinistra

OLSEN-HEGAR



18.0331 12 cm
 glatt
 smooth
 lisse
 lisa
 liscio



18.0332
14 cm

OLSEN-HEGAR



18.0334
16,5 cm



18.0336
18,5 cm



18.0340
12 cm
 gerieft
 serrated
 strié
 estriada
 con striatura

KAYE



18.0341
12 cm
 glatt
 smooth
 lisse
 lisa
 liscio

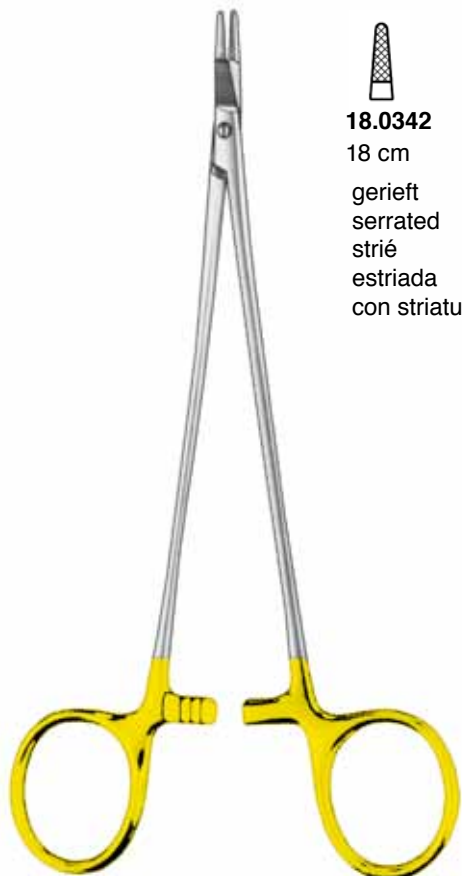

KAYE



18.0342
 18 cm
 gerieft
 serrated
 strié
 estriada
 con striatura



18.0343
 18 cm
 glatt
 smooth
 lisse
 lisa
 liscio

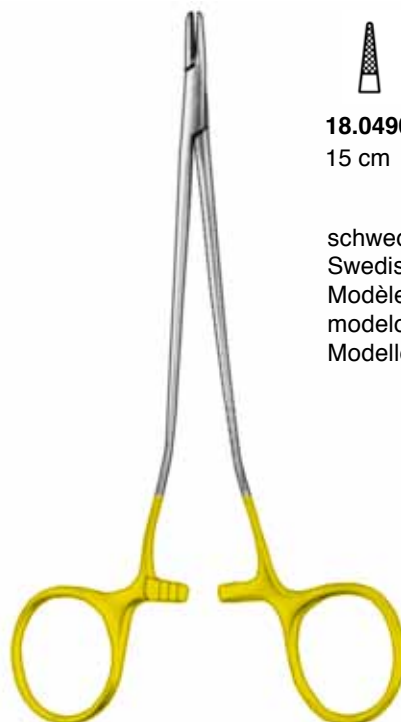

PRO-MED



18.0490
 15 cm

schwedisches Modell
 Swedish model
 Modèle swedoise
 modelo sueco
 Modello svedese

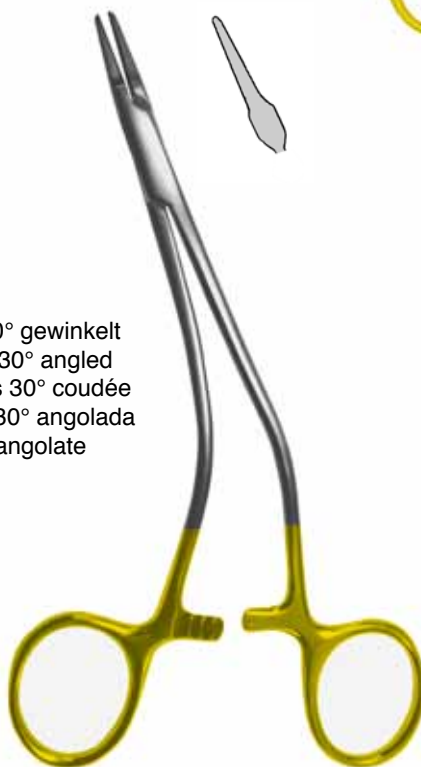

PAREL
18.0571 14 cm
18.0573 17 cm

Intranasal Nadelhalter 30° gewinkelt
 Intranasal Needleholder 30° angled
 Intranasal Porte-Aiguilles 30° coudée
 Intranasal Porta-Agujas 30° angolada
 Intranasal Port'Aghi 30° angolate



18.1010
12 cm



18.1012
12,5 cm

DERF



COLLIER
18.1015 12,5 cm

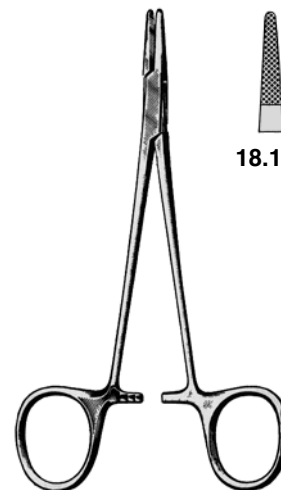
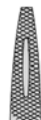

HALSEY
13 cm

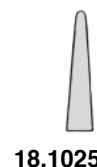
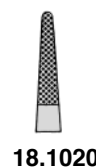

18.1020

18.1025



WEBSTER
18.1026 13 cm



BAUMGARTNER
18.1030 14 cm

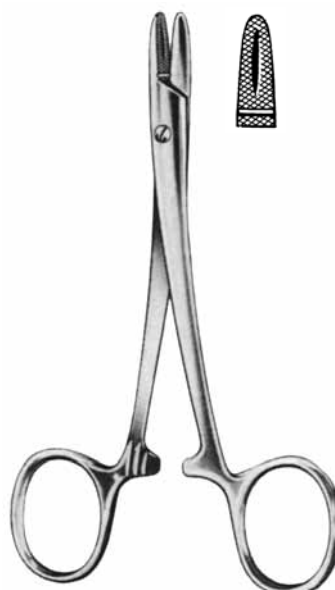

DOYEN
18.1035 12,5 cm



KILNER
18.1040 13 cm



Maul glatt mit Spezialkehle
 Smooth jaws, with special groove
 Mâchoires lisses, avec cannelure spécial
 Bocas lisas, con acanaladura especial
 morso liscio con scannellatura speciale



NEIVERT
 18.1050 12 cm



CRILE
 18.1060 15 cm



CRILE-MURRAY
 18.1065 15 cm



CRILE-WOOD
 18.1070 15 cm



CRILE-WOOD
 18.1072 18 cm

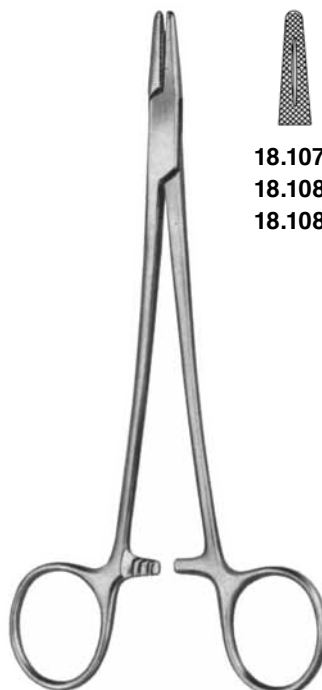

MAYO-HEGAR

18.1078 14 cm
 18.1080 16 cm
 18.1082 18 cm



METZENBAUM
 18.1100 18 cm



18.1250
14 cm



18.1252
17 cm



18.1260 14 cm
18.1262 17 cm



mit Innensperre
with inside ratchet
avec crémaillère interne
con cremallera interior
con cremagliera interna

MATHIEU

MATHIEU-SLIM

MATHIEU

18.1270 14 cm
18.1272 17 cm

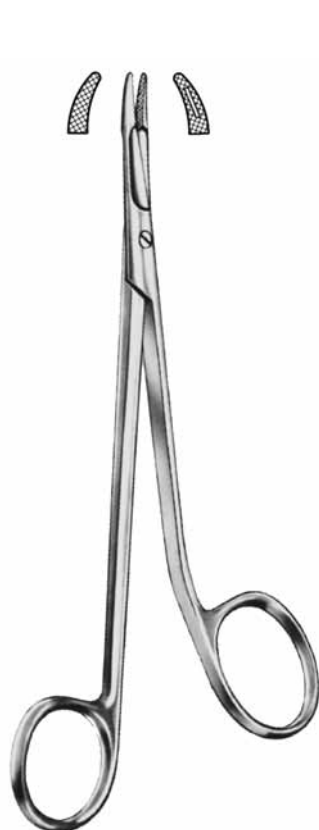

GILLIES-MINI
18.1320 15 cm



GILLIES
18.1322 16 cm



OLSEN-HEGAR
18.1330 12 cm
18.1330L 12 cm

für Linkshänder/for left-handers/pour gauchers
para zurdos/per mono sinistra



OLSEN-HEGAR
18.1332 14 cm
18.1334 16,5 cm
18.1336 18 cm

SONDEN, ASPIRATION, PUNKTION, INJEKTION
PROBES, ASPIRATION, PUNCTURE, INJECTION
STYLETS, ASPIRATION, PUNCTURE, INJECTION
ESTILETES, ASPIRACION, PUNCIÓN, INYECCION
SPECILLI, ASPIRAZIONE, PUNTURA, INIEZIONE

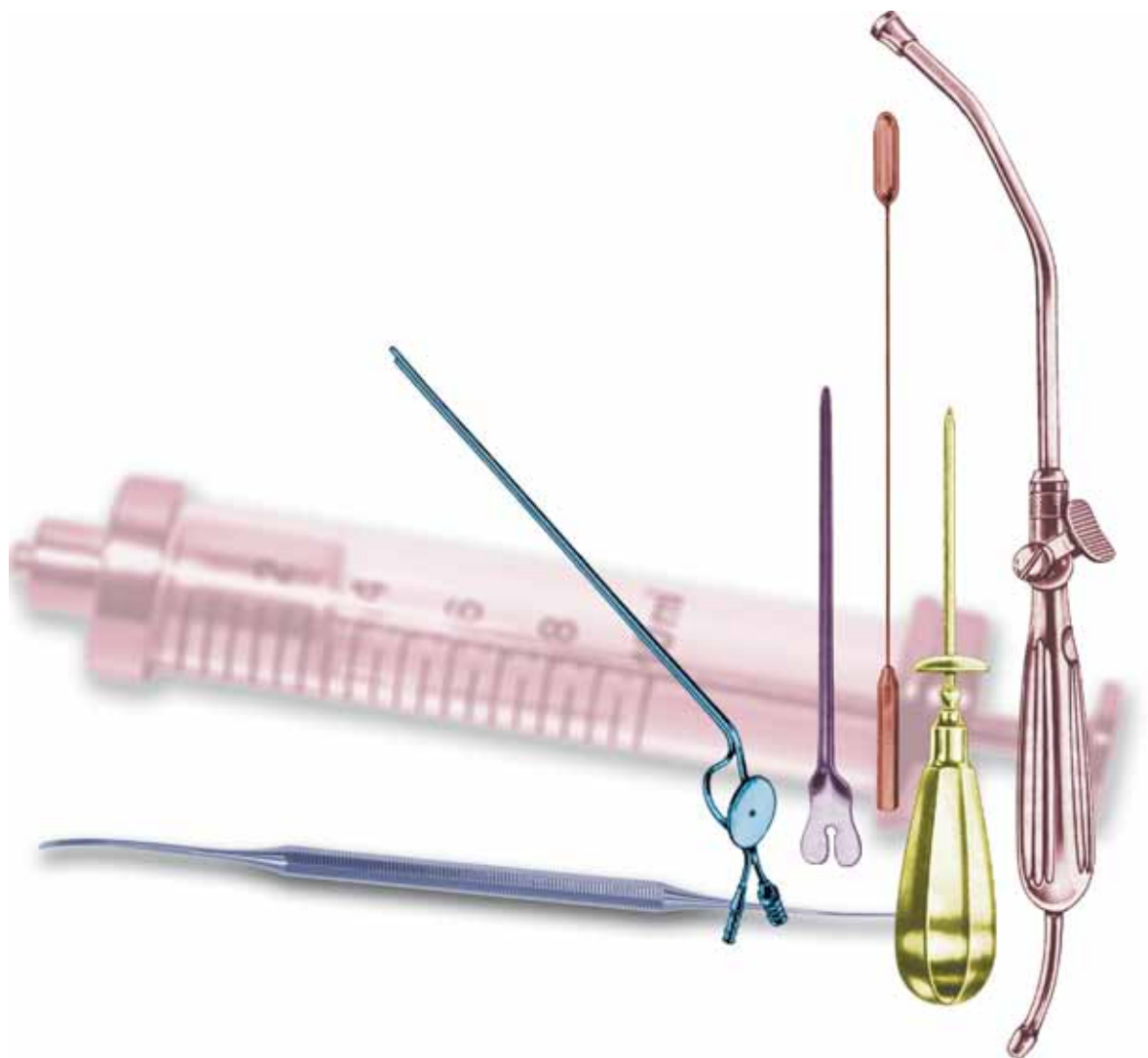

Sonden und Dilatatore
 Probes and Dilators
 Stylets et dilatateurs
 Sondas exploradoras y dilatadoras
 Sonde esploratrici e dilatatori



geknöpft / probe-ended / boutonés /
 abotonados / bottonuta

		Ø / mm
30.1700	#00/0 NS	0,7 / 0,8
30.1701	# 0/1 NS	0,8 / 0,9
30.1702	# 1/2 NS	0,9 / 1,1
30.1703	# 2/3 NS	1,1 / 1,3
30.1704	# 3/4 NS	1,3 / 1,4
30.1705	# 4/5 NS	1,4 / 1,5
30.1706	# 5/6 NS	1,5 / 1,6
30.1707	# 6/7 NS	1,6 / 1,8
30.1708	# 7/8 NS	1,8 / 1,9

Neusilber
 German silver
 Argent blanc
 plata alemana
 argentone

BOWMAN



zylindrisch / cylindrical / cylindriques /
 cilindricos / cilindrico

		Ø / mm
30.1738	#0000/000 NS	0,5 / 0,6
30.1740	# 00/0 NS	0,7 / 0,8
30.1741	# 0/1 NS	0,8 / 0,9
30.1742	# 1/2 NS	0,9 / 1,1
30.1743	# 2/3 NS	1,1 / 1,3
30.1744	# 3/4 NS	1,3 / 1,4
30.1745	# 4/5 NS	1,4 / 1,5
30.1746	# 5/6 NS	1,5 / 1,6
30.1747	# 6/7 NS	1,6 / 1,8
30.1748	# 7/8 NS	1,8 / 1,9

Neusilber
 German silver
 Argent blanc
 plata alemana
 argentone

BOWMAN

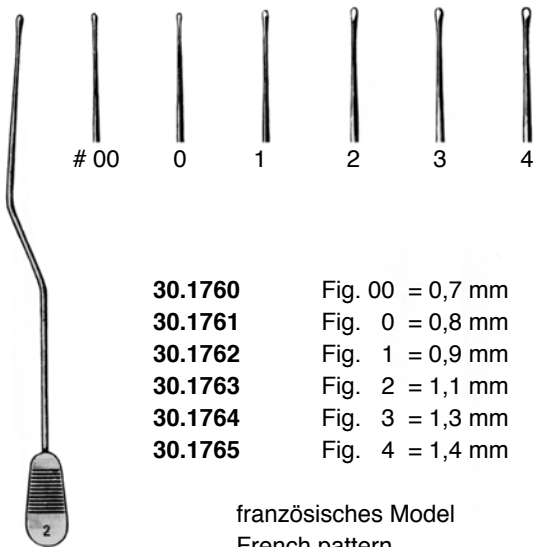

30.1760	Fig. 00 = 0,7 mm
30.1761	Fig. 0 = 0,8 mm
30.1762	Fig. 1 = 0,9 mm
30.1763	Fig. 2 = 1,1 mm
30.1764	Fig. 3 = 1,3 mm
30.1765	Fig. 4 = 1,4 mm

französisches Model
 French pattern
 Modèle française
 Modelo francés
 Modello francese

12,5 cm

Ohr- und Sinussonden
 Ear- and Sinus Probes
 Sondes auriculaires et nasales
 Sondas auriculares y para seno
 Sonde auricolari e per seno



Silber
 Silver
 Argent
 Plata
 Argento

STACKE
19.0249
 11 cm / Ø 1mm



FISH
19.0250 14 cm / Ø 2 mm
19.0252 18 cm / Ø 2 mm



RITTER-HALLE
33.1120 16 cm / Ø 2,5 mm
33.1122 16 cm / Ø 3,0 mm
33.1124 16 cm / Ø 4,0 mm
33.1125 16 cm / Ø 5,0 mm



ANDREW-PYNCHON
19.0700 24 cm



mit 2 Ansätzen
with 2 tips
avec 2 embouts
con 2 puntas
con 2 punte
1,5 / 2,0 mm Ø

COUPLAND
33.1160 26 cm

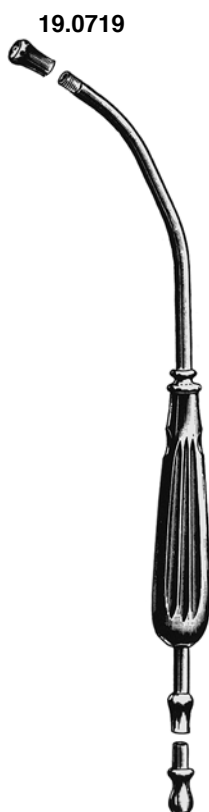

19.0719

YANKAUER
19.0710 27 cm
Ø 10 mm
komplett
complete
complet
completo

19.0718



mit Absperrventil u. abschraubbarem Rohr
with stopcock and removeable tube
avec robinet et canule demontable
con llave y tubo desmontable
con interruttore e tubo svitabile

YANKAUER
19.0715 33 cm
Ø 10 mm



POOLE
19.0726
20 cm, Ø 5,5mm



POOLE
19.0727
20 cm, Ø
5,5mm



POOLE
19.0720
23 cm / 30 Fr.



POOLE
19.0721
20 cm / 23 Fr.
Ø 8 mm

PRO-MED ist Ihnen behilflich bei der Zusammenstellung von Operationsbestecken für die verschiedensten Disziplinen. Fragen Sie nach unseren vorbereiteten OP-Bestecken.

For your convenience a wide variety of Suggested Operating Sets for most general and specialized procedures is available from **PRO-MED**. Please contact us or your local dealer.

PRO-MED vous propose de multiples compositions de boîtes opératoires multidisciplinaires. Demandez nos suggestions pour de nombreuses interventions.

PRO-MED le ayuda en componer varias cajas de instrumentos quirúrgicos. Pregunte por nuestro instrumental quirúrgico preparado.

Per la vostra comodità **PRO-MED** Vi aiuta nella raccolta di strumenti chirurgici per le varie discipline. Vi preghiamo di chiedere informazioni sui nostri set di strumenti chirurgici già preparati.

STERILISATION
STERILIZATION
STERILISATION
ESTERILIZACION
STERILIZZAZIONE

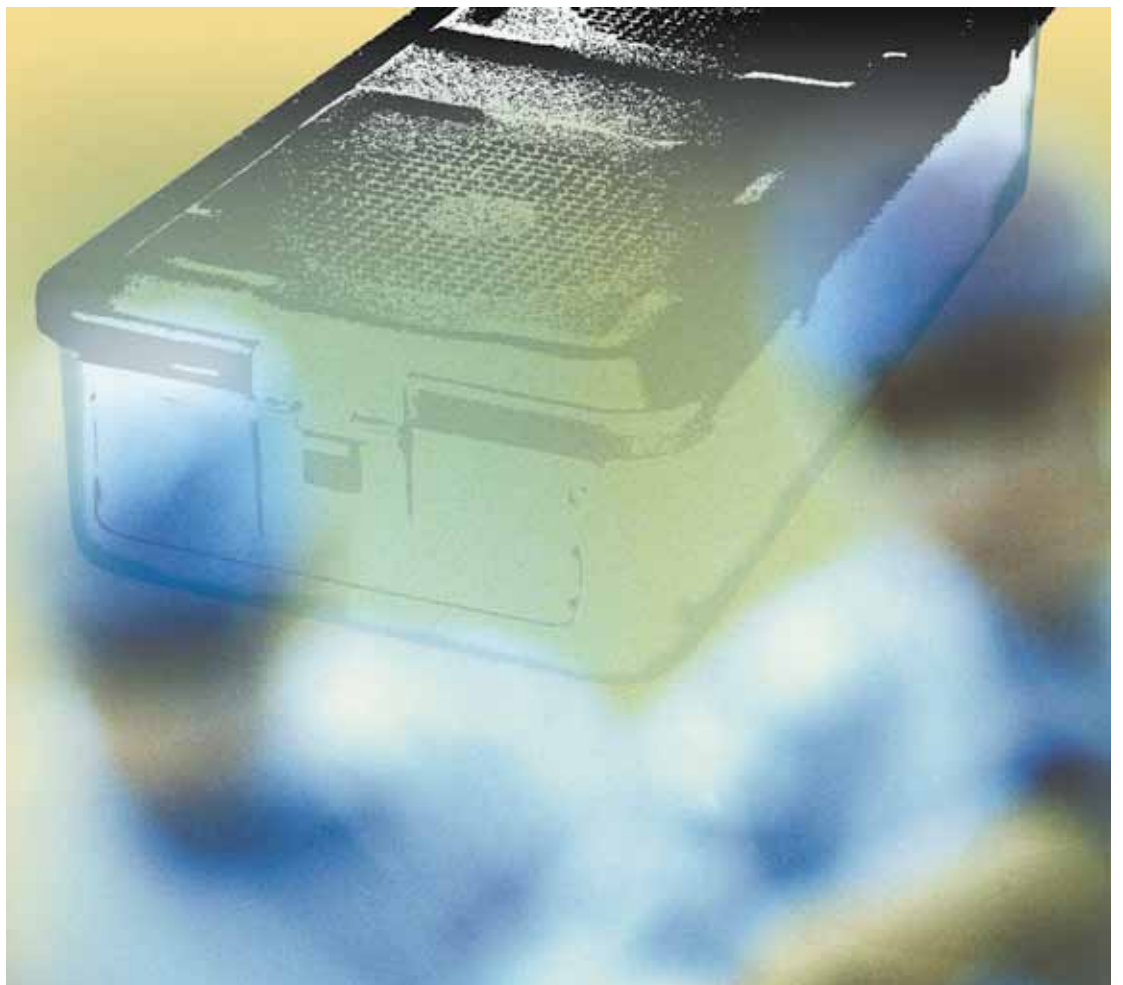



DAVIS

16.1000 16 cm
16.1002 20 cm
16.1004 25 cm



CHEATTLE

16.1010 27 cm



ROGGE

16.1020 23 cm



STERILIZING

16.1030 20 cm
16.1032 30 cm



STERILIZING

16.1040 20 cm
16.1042 28 cm

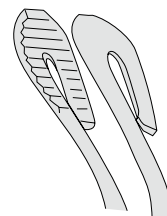

16.1041 20 cm
16.1043 28 cm

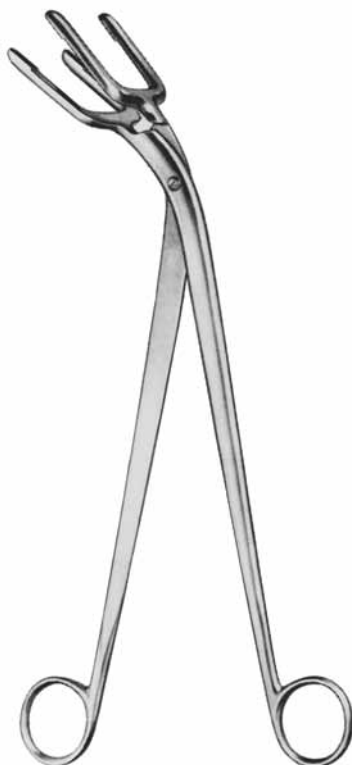

HARRISON

16.1050 25 cm
16.1052 30 cm



MARTIN

16.1060 58 cm



SAUERBRUCH

16.1070 55 cm



BUNT
16.1100
12 cm

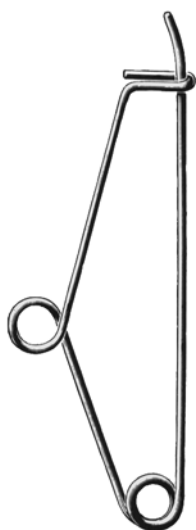

MAYO
16.1110
14 cm



MAYO
16.1115
14 cm



STRINGER

16.1150	10 x 7 cm
16.1152	15 x 7 cm
16.1153	20 x 7 cm
16.1154	25 x 7 cm
16.1155	30 x 7 cm
16.1156	35 x 7 cm
16.1157	40 x 7 cm
16.1158	45 x 9 cm
16.1159	50 x 9 cm



16.1500

Infusionsflaschen-Öffnungszange
Infusion-bottle Opening Forceps
Pince pour ouvrir les bouteilles d'infusion
Pinza para abrir botellas de infusión
Pinza apri flebo

1/2 Container, ALU

Deckel gelocht und farbig
 Lid perforated and colored
 Couvercle perforé et coloré
 Tapas perforadas y coloreados
 Coperchio perforato e colorato



L x B x H mm

285x280x100	80.6001	80.6002	80.6003	80.6004	80.6005	80.6006
285x280x135	80.6011	80.6012	80.6013	80.6014	80.6015	80.6016
285x280x150	80.6021	80.6022	80.6023	80.6024	80.6025	80.6026
285x280x200	80.6031	80.6032	80.6033	80.6034	80.6035	80.6036
285x280x260	80.6041	80.6042	80.6043	80.6044	80.6045	80.6046

Zubehör · Accessories · Accessoires · Accesorios · Accessori

für
1/2 Container

for
1/2 Containers

pour
1/2 Containers

para
1/2 Contenedores

per
1/2 Contenitori



Siebkörbe
Wire baskets
Plateaux inox
Bandejas inoxidable
Cestelli in acciaio fino

80.6203 255x245x 30 mm
80.6205 255x245x 50 mm
80.6207 255x245x 70 mm
80.6210 255x245x100 mm

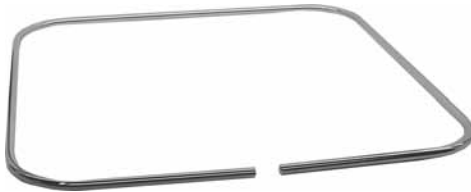

Spannrahmen
Cloth fixing frames
Cadres fixe-toile
Cuadros para fijar panos
Telai fissateli

80.6231 255x255 mm



80.6232 255x255x30 mm



Teiler
Deviders
Cloisons
Tabiques
Divisori

80.6240 255x245x130 mm

3/4 Container, ALU

Deckel gelocht und farbig
 Lid perforated and colored
 Couvercle perforé et coloré
 Tapas perforadas y coloreados
 Coperchio perforato e colorato

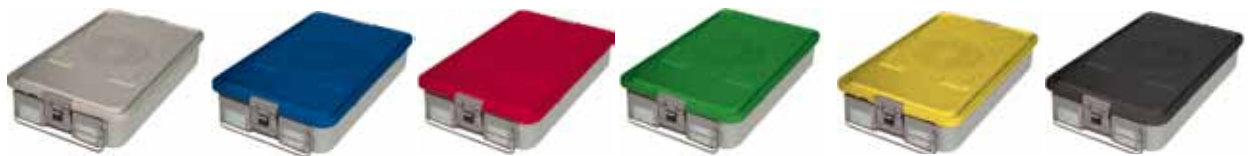

L x B x H mm

465x280x100	80.6301	80.6302	80.6303	80.6304	80.6305	80.6306
465x280x135	80.6311	80.6312	80.6313	80.6314	80.6315	80.6316
465x280x150	80.6321	80.6322	80.6323	80.6324	80.6325	80.6326

Zubehör · Accessories · Accessoires · Accesorios · Accessori

für
3/4 Container

for
3/4 Containers

pour
3/4 Containers

para
3/4 Contenedores

per
3/4 Contenitori

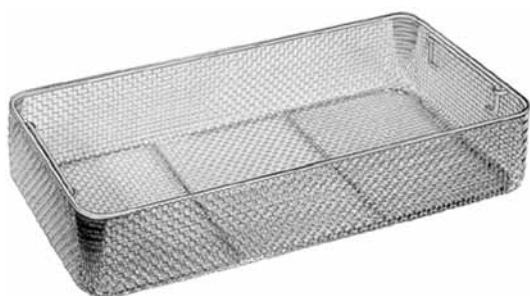

Siebkörbe
Wire baskets
Plateaux inox
Bandejas inoxidable
Cestelli in acciaio fino

80.6503	405x245x 30 mm
80.6505	405x245x 50 mm
80.6507	405x245x 70 mm
80.6510	405x245x100 mm



Spannrahmen
Cloth fixing frames
Cadres fixe-toile
Cuadros para fijar panos
Telai fissateli

80.6531	405x255 mm
---------	------------



80.6532	405x255x30 mm
---------	---------------

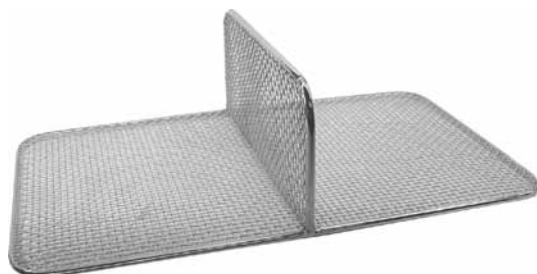

Teiler
Deviders
Cloisons
Tabiques
Divisori

80.6540	405x250x130 mm
---------	----------------



80.6541	405x250x130 mm
---------	----------------

1/1 Container, ALU

Deckel gelocht und farbig
 Lid perforated and colored
 Couvercle perforé et coloré
 Tapas perforadas y coloreados
 Coperchio perforato e colorato

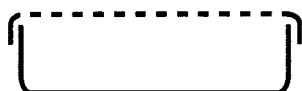

L x B x H mm

580x280x100	80.6601	80.6602	80.6603	80.6604	80.6605	80.6606
580x280x135	80.6611	80.6612	80.6613	80.6614	80.6615	80.6616
580x280x150	80.6621	80.6622	80.6623	80.6624	80.6625	80.6626
580x280x200	80.6631	80.6632	80.6633	80.6634	80.6635	80.6636
580x280x260	80.6641	80.6642	80.6643	80.6644	80.6645	80.6646

Zubehör · Accessories · Accessoires · Accesorios · Accessori

für
1/1 Container

for
1/1 Containers

pour
1/1 Containers

para
1/1 Contenedores

per
1/1 Contenitori

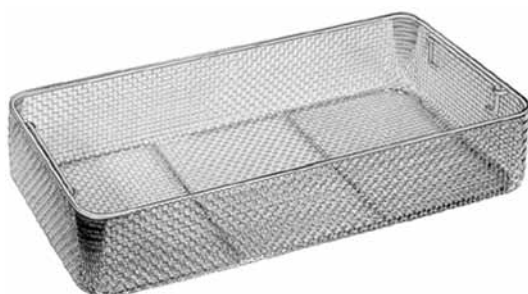

Siebkörbe
Wire baskets
Plateaux inox
Bandejas inoxidable
Cestelli in acciaio fino

80.6803	485x285x 30 mm
80.6805	485x285x 50 mm
80.6807	485x285x 70 mm
80.6810	485x285x100 mm
80.6813	540x285x 30 mm
80.6815	540x285x 50 mm
80.6817	540x285x 70 mm
80.6820	540x285x100 mm



Spannrahmen
Cloth fixing frames
Cadres fixe-toile
Cuadros para fijar panos
Telai fissateli

80.6841	545x245 mm
---------	------------



80.6842 5	45x245x30 mm
-----------	--------------



Teiler
Deviders
Cloisons
Tabiques
Divisori

80.6850	510x250x130 mm
---------	----------------

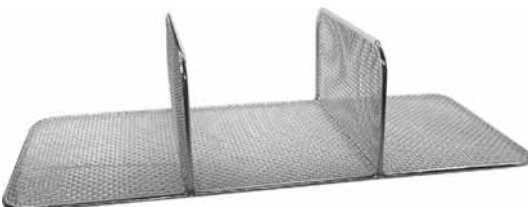

80.6851	510x250x130 mm
---------	----------------

Flach- und Mini-Container, ALU eloxiert

Flat- and Mini-Containers, ALU

Containers plates et mini en aluminium

Contenedores planos y mini de aluminio

Contentori piatti e mini in alluminio



Deckel gelocht und farbig
 Lid perforated and colored
 Couvercle perforé et coloré
 Tapas perforadas y coloreados
 Coperchio perforato e colorato



Flach – Flat – Plat – Plano – Platto



L x B x H mm

285x280x55	80.7001	80.7002	80.7003	80.7004	80.7005	80.7006
285x280x85	80.7011	80.7012	80.7013	80.7014	80.7015	80.7016



Mini



L x B x H mm

300x140x40	80.7301	80.7302	80.7303	80.7304	80.7305	80.7306
300x140x70	80.7311	80.7312	80.7313	80.7314	80.7315	80.7316
300x140x100	80.7321	80.7322	80.7323	80.7324	80.7325	80.7326

Zubehör · Accessories · Accessoires · Accesorios · Accessori

für FLACH- und
MINI-Container

for FLAT- and MI-
NI-Containers

pour Containers
PLARTS et MINI

para Contenedores
PLANOS y MINI

per Contenitori
PIATTI e MINI



Siebkorb mit Deckel
Wire basket with lid
Panier avec couvercle
Cestillo con cobertera
Cestello con coperchio

80.7410 267x125x50 mm



Siebeinlage f. MINI-Container
Separate base for MINI-Container
Fond du crible pour MINI-Container
Base para MINI-Container
Base per MINI-Container

80.7420 270x125 mm



Spannrahmen für Mini-Container
Cloth fixing frames for MINI-Container
Cadres fixe-toile pour MINI-Container
Cuadros para fijar panos para MINI-Container
Telai fissateli per MINI-Container

80.7431 270x125 mm

Endoskopie-Container, ALU eloxiert

Endoscopy-Containers, ALU

Containers a endoscopie en alumium

Contenedores para endoscopiade aluminio

Contentitori per endoscopia in alluminio

Deckel gelocht und farbig

Lid perforated and colored

Couvercle perforé et coloré

Tapas perforadas y coloreados

Coperchio perforato e colorato

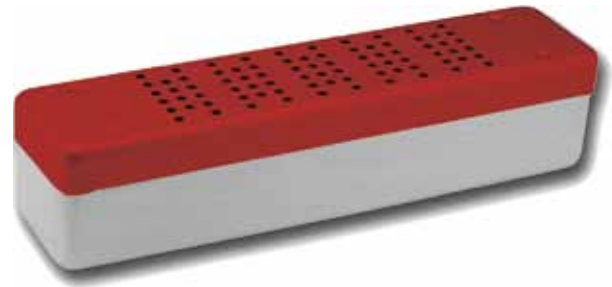

L x B x H mm

250x60x50

80.7501

80.7503

80.7504

450x70x70

80.7511

80.7513

80.7514

Zubehör · Accessories · Accessoires · Accesorios · Accessori

Siebköbe Endoskopie

Wire baskets Endoscopy

Paniers Endoscopie

Cestillos Endoscopia

Cestilli Endoscopia

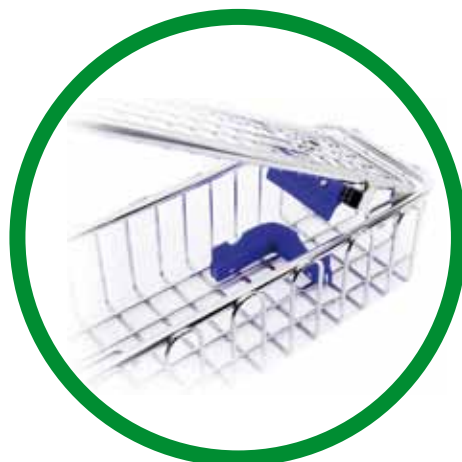

80.7551 290x 80x50 mm

80.7552 460x 80x50 mm

80.7553 640x150x77 mm

Zubehör · Accessories · Accessoires · Accesorios · Accessori

Kennzeichnungsschilder, Aluminium ohne Text
Identification labels, aluminium, neutral
Plaquettes d'identificationen aluminium, neutres
Placas de identificación, aluminio, neutral
Targhette di identificazione d'alluminio, neutre



80.7901 80.7902 80.7903 80.7904 80.7905 80.7906

Kennzeichnungsschilder, Aluminium graviert
Identification labels, aluminium, engraved
Plaquettes d'identificationen aluminium, gravées
Placas de identificación, aluminio, grabadas
Targhette di identificazione d'alluminio, incise



80.7911 80.7912 80.7913 80.7914 80.7915 80.7916

Sortiermagazin für Kennzeichnungsschilder
Rack for identification labels
Magasin à plaquettes d'identification
Cajita para seleccionar placas
Cassetta da selezione tharghette

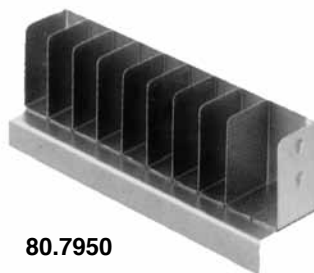

80.7950

Indikator-Schilder, Papier, 100 St.
Indicating labels, paper, 100 pcs.
Etiquettes d'identification en papier, les 100
Etiquetas indicadoras, papel 100 c/u
Targhette con indicatore, papel, 100 pezzi



80.7960

klein / small / petite / pequenas / piccolo

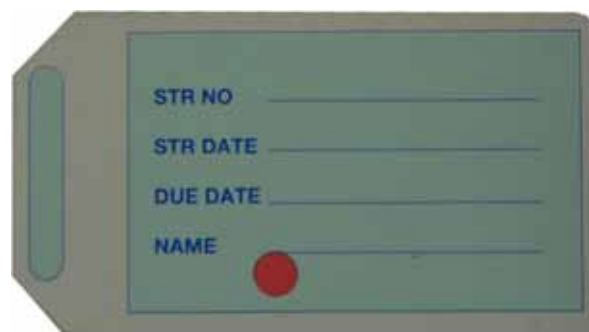

80.7962

groß / large / grande / grande / grande

Sicherungsplomben, Plastik, 100 St.
Safety Seals, plastic, 100 pcs.
Scellés de sécurité, plastique, les 100
Precintos de seguridad,plastico 100 c/u
Sigilli di sicurezza, plastica, 100 pezzi



80.7980

Zubehör · Accessories · Accessoires · Accesorios · Accessori

Filterspender für 1/2, 3/4, 1/1 Container-Filter
Filter Dispenser for 1/2, 3/4, 1/1 Container-Filters
Présentoir de filtres pour les 1/2, 3/4, 1/1 Containers
Distribuidor de filtros para los 1/2, 3/4, 1/1 Containers
Distributore di filtri per 1/2, 3/4, 1/1 Container



80.8000

Filterhalter für 1/2, 3/4, 1/1 Container
Filter Holder for 1/2, 3/4, 1/1 Containers
Fixe-filtres pour 1/2, 3/4, 1/1 Containers
Sujetafiltros para los 1/2, 3/4, 1/1 Containers
Fermafiltro per 1/2, 3/4, 1/1 Container



80.8010

Filter, Einmalgebrauch, Papier 1000 St.
Single use filters, paper 1000 pcs.
Filtres en papier à usage unique, les 1000
Filtros, monouso, papel, 1000 c/u
Filtri, monouso, carta, 1000 pezzi

FILTER, Papier für 1/2, 3/4, 1/1 Container
for 1/2, 3/4, 1/1 Containers
pour 1/2, 3/4, 1/1 Containers
para los 1/2, 3/4, 1/1 Containers
per 1/2, 3/4, 1/1 Container

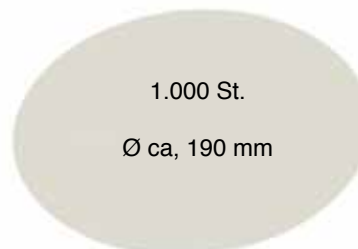

80.8050

FILTER, Papier für MINI-Container
for MINI-Containers
pour MINI-Containers
para MINI-Containers
per MINI-Containers

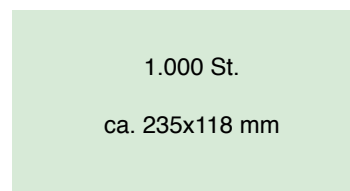

80.8052

FILTER, Papier für DENTAL Container
for DENTAL-Containers
pour DENTAL-Containers
para DENTAL-Containers
per DENTAL-Containers

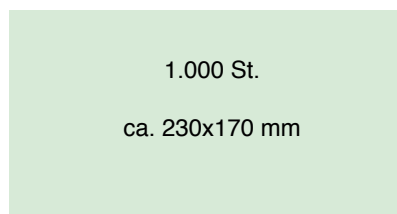

80.8054

Zubehör · Accessories · Accessoires · Accesorios · Accessori

Langzeit-Textilfilter, 1 St.
Long-term textile filters, 1 pc.
Filtres en textile, la pièce
Filtros de textil, 1 c/u
Filtri tessili, il pezzo

FILTER, Textil für 1/2, 3/4, 1/1 Container
for 1/2, 3/4, 1/1 Containers
pour 1/2, 3/4, 1/1 Containers
para los 1/2, 3/4, 1/1 Containers
per 1/2, 3/4, 1/1 Container

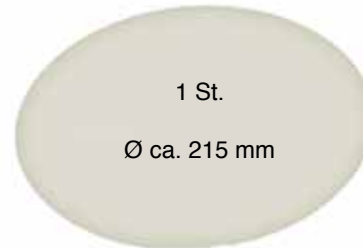

80.8060

FILTER, Textil für MINI-Container
for MINI-Containers
pour MINI-Containers
para MINI-Containers
per MINI-Containers

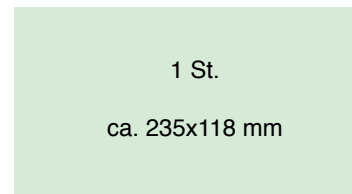

80.8062

FILTER, Textil für DENTAL Container
for DENTAL-Containers
pour DENTAL-Containers
para DENTAL-Containers
per DENTAL-Containers

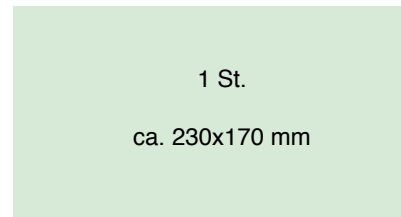

80.8064

Sterilisier-Tücher, Baumwolle
Sterilizing Drapes, cotton
Champs à stérilisation, coton
Paños de esterilización de algodón
Pannos di sterilizzazione, cotone

80.8100 40 x 60 cm
80.8105 85 x 85 cm
80.8110 100 x 140 cm
80.8115 275 x 125 cm
80.8120 245 x 245 cm



80.8100-
80.8120

Noppenmatten, Silikon
Silicone Pads
Tapis port-instruments, silicone
Tapices porta instrumentos de silicona
Tapetti porta-strumenti in silicone

80.8131 275 x 125 mm
80.8132 225 x 225 mm
80.8133 300 x 300 mm



80.8131-
80.8133

Zubehör · Accessories · Accessoires · Accesorios · Accessori

Fixierklammern für Tücher
Fixation Clamps for Drapes
Pinces fixe-toiles
Grapas para fijar paños
Pinze di fillaggio per teli



80.8150

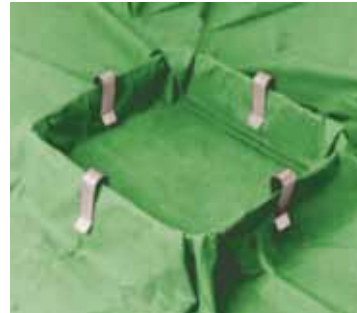

- 80.8160** Ø 7 - 12 mm
- 80.8161** Ø 12 - 16 mm
- 80.8162** Ø 16 - 26 mm
- 80.8163** Ø 26 - 36 mm
- 80.8164** Ø 36 - 45 mm



**80.8160-
70.8164**

Fixierfedern
Spiral Supports
Ressorts spiraux
Apoyos con resorte spiral
Supporte a molle

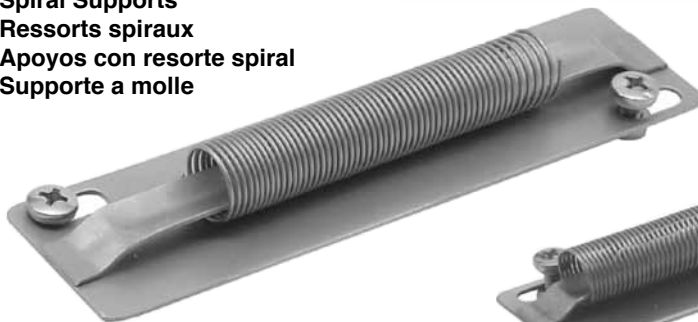

80.8191 115 x 30 mm



80.8192 230 x 30 mm

80.8140 SILIKON Fixierstreifen Set

bestehend aus:

80.8141 1 Silikon Streifen 246 x 13 mm

80.8142 2 Silikon Halteknöpfe

SILICONE Storage Strip Set

consisting of:

80.8141 1 Silicone Storage Strip 246x13 mm

80.8142 2 Silicone Fastening Knobs

SILICONE bande porte instrum. 243 x 13 mm

Jeu comprenant:

80.8141 1 Silicone bande à sécurité 243 x 13 mm

80.8142 2 Silicone boutons à fixation

SILICONE tira de protección 243 x 13 mm

Juego compuesto de:

80.8141 1 Silicone tira de protección 243 x 13 mm

80.8142 2 Silicone botones de fijar

SILICONE strisce per assicurare 243x13 mm

Set composto da:

80.8141 1 Silicone strisce per assicurare 243x13 mm

80.8142 2 Silicone botoni de fissare



80.8141 246x13 mm



80.8142 2 Stück / 2 pieces / 2 pièces / 2 piezas / 2 pezzi

Zubehör · Accessories · Accessoires · Accesorios · Accessori

Haltestifte, Trennbleche
Fixing bolts, Dividers
Attaches de fixation, Séparateurs
Piñons para fijar, Separadores
Perne di fissaggio, Divisori

Haltestift für Instrumente
for instruments
pour instruments
para instrumentos
per strumenti



80.8201

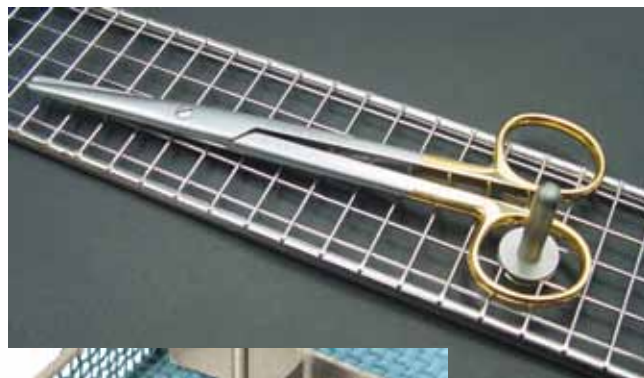

Haltestift für Trennbleche
for Dividers
pour Séparateurs
para Separadores
per Divisori



80.8202

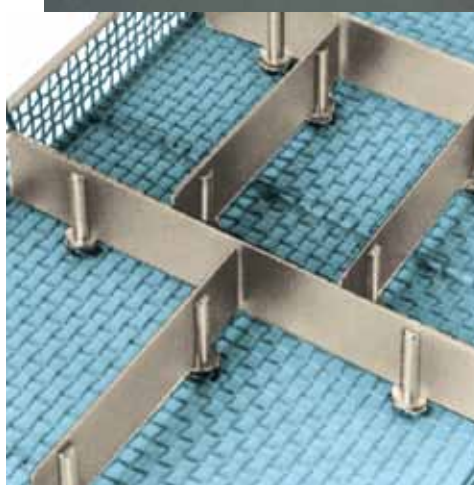

Trennbleche
Dividers
Séparateurs
Separadores
Divisori

80.8211 50x20 mm
80.8212 130x20 mm
80.8213 225x20 mm
80.8214 460x20 mm



Sterilisierahmen für 8 Mikro-Instrumente
Sterilizing Rack for 8 Micro-Instruments
Chevalet à Sterilisation pour 8 Micro-Instruments
Porta-instrumentos para 8 Micro Instrumentos
Telaio per sterilizzazione per 8 micro-strumenti

80.3190 190 x 36 x 35 mm

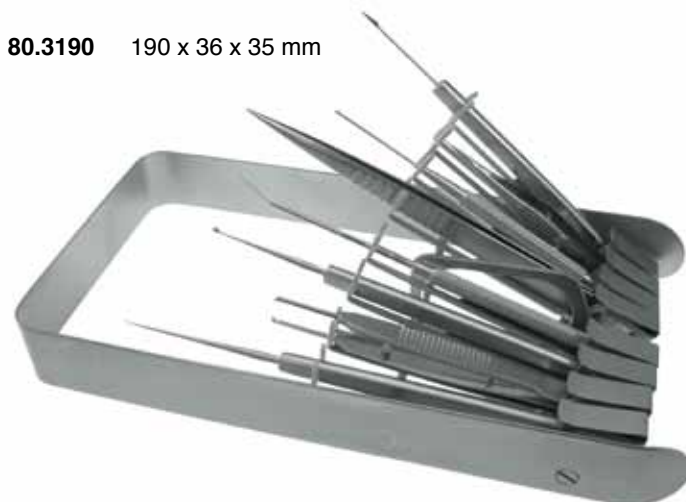

Winkelbleche
Angled Dividers
Séparateurs angulés
Separadors angulados
Divisori angulate

80.8221 110 mm
80.8222 170 mm
80.8223 230 mm
80.8223 470 mm



Sterilisation · Sterilization · Sterilisation · Esterilizacion · Sterilizzazione

Container für mikrochirurgische Instrumente
 Containers for microsurgical instruments
 Containers pour instruments de microchirurgie
 Contenedores para instrumental microcirugia
 Contenitori per strumenti per microchirurgia



80.3112 300x220x55 mm
80.3114 285x280x55 mm
80.3116 400x290x55 mm



80.3162 300x220x75 mm
80.3164 285x280x75 mm
80.3166 400x290x75 mm

Sterilisiertrommeln
 Sterilizing drums
 Boites rondes à sterilisation
 Tambores de esterilizacion
 Cestelli rotondi per sterilizzazione

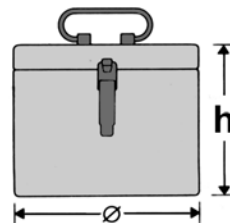

SCHIMMELBUSCH			
80.4002	120x120 mm	80.4016	240x240 mm
80.4004	140x140 mm	80.4018	290x160 mm
80.4006	160x120 mm	80.4020	290x240 mm
80.4008	160x150 mm	80.4022	340x160 mm
80.4010	190x150 mm	80.4024	340x240 mm
80.4012	190x190 mm	80.4026	390x190 mm
80.4014	240x160 mm	80.4028	390x290 mm



80.4002-80.4028

KONRICH			
80.4040	96 x 99 mm	80.4054	285 x 240 mm
80.4042	156 x 146 mm	80.4056	334 x 158 mm
80.4044	188 x 140 mm	80.4058	334 x 238 mm
80.4046	188 x 185 mm	80.4060	384 x 138 mm
80.4048	239 x 160 mm	80.4062	384 x 188 mm
80.4050	239 x 240 mm	80.4064	384 x 288mm
80.4052	285 x 160 mm		



80.4040-80.4064

Zubehör · Accessories · Accessoires · Accesorios · Accessori

Pflegeöl für chirurgische Instrumente
Lubricating Oil for Surgical Instruments
Huile pour lubrifier les instruments chirurgicaux
Lubrificante para las instrumentos quirúrgicos
Olio per lubrificazione di strumenti chirurgici

80.0010 50 cc.
80.0012 250 cc.
80.0014 1000 cc.



80.0010

Wattespender
Cotton dispensers
Distributeurs de coton
Dispensores de algodón
Distributore del cotone

80.1000 75 x 50 Ø
80.1002 115 x 75 Ø



80.1000-
80.1002

Watteabfallbehälter
Cotton Waste Collector
Poubelle pour coton
Recipiente para algodón
Recipiente per cotone usato

80.1010 75 x 50 Ø
80.1012 100 x 75 Ø



80.1010-
80.1012

Nadeldosen
Needle Cases
Boîtes à aiguilles
Estuches para agujas
Astucci per aghi

80.2000 65x17 mm
komplett - complete - complet - completo - completo



80.2000

80.2009 Innendose allein für 80.2000
insert only for 80.2000
boîte int Érieure seulement pour 80.2000
Caja interior suelta para 80.2000
Scatola interna sola per 80.2000

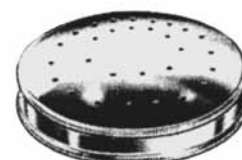

80.2009

Zubehör · Accessories · Accessoires · Accesorios · Accessori

80.2020 150x95x13 mm



80.2020

80.2030 50x25x4,5 mm

80.2031 65x42x8,0 mm

80.2032 75x25x4,5 mm

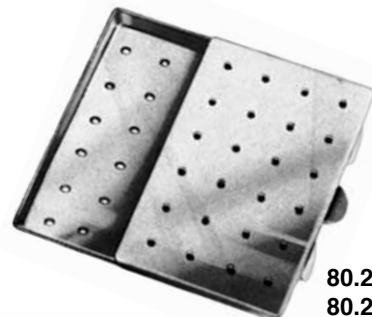

**80.2030-
80.2032**

SAUERBRUCH

80.2060



80.2060

Meßbecher
Measuring jugs
Gobelets gradués
Copas graduadas
Misurini

80.2070 0,25 l.

80.2072 0,5 l.

80.2074 1,0 l.

80.2076 1,5 l.

80.2078 2,0 l.



80.2070 -80.2090

Petrischale
Petri Dish
Boîte de Petri
Cubeta de Petri
Scodella di Petri

80.2090 100 X 20 mm



80.2090

Zubehör · Accessories · Accessoires · Accesorios · Accessori

Nierenschalen
Kidney bowls
Bassins réniformes
Riñoneras
Padelle reniformi

80.2100	170 x 37 mm
80.2101	205 x 45 mm
80.2102	250 x 39 mm
80.2104	275 x 45 mm



80.2100 -
80.2104

Runde Schalen
Round Bowls
Cuvettes rondes
Cubetas redondas
Scodelle rotonde

80.2200	40 x 19 mm	0,05 l
80.2202	60 x 30 mm	0,07 l
80.2204	80 x 40 mm	0,14 l
80.2206	100 x 50 mm	0,20 l
80.2208	120 x 55 mm	0,35 l
80.2210	150 x 65 mm	0,70 l



80.2200 -
80.2210

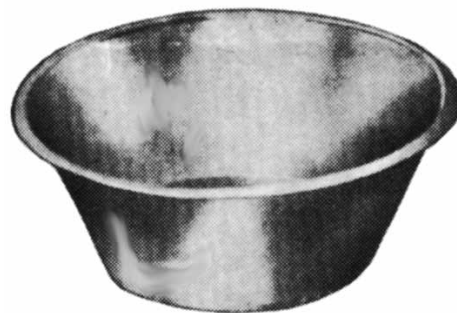

80.2240 -
80.2262

80.2240	150 x 74 mm	0,75 l
80.2242	160 x 65 mm	1,00 l
80.2244	220 x 70 mm	2,00 l
80.2246	225 x 90 mm	2,50 l
80.2248	240 x 95 mm	3,00 l
80.2250	255 x 115 mm	4,00 l
80.2252	260 x 130 mm	4,50 l
80.2254	300 x 105 mm	6,00 l
80.2256	310 x 120 mm	6,00 l
80.2258	320 x 140 mm	8,00 l
80.2260	380 x 125 mm	11,00 l
80.2262	400 x 150 mm	14,00 l

Kappenzangen mit Behälter und Deckel
Sterilizing Forceps with jar and lid
Pincas à stérilisation avec éprouvette et couvercle
Pinzas para esterilización con recipiente y tapa
Pinze per sterilizzazione con recipiente e coperchio

80.2270	25 cm
80.2272	32 cm



80.2270 -
80.2272

Zubehör · Accessories · Accessoires · Accesorios · Accessori

Standgefäße

Jars

Récipients cylindriques

Tarros

Recipienti cilindrici

80.2280	30 x 90 mm
80.2282	50 x 100 mm
80.2284	50 x 135 mm
80.2286	50 x 180 mm
80.2288	80 x 130 mm
80.2290	80 x 180 mm
80.2292	100 x 200 mm



**80.2280 -
80.2292**

Medizinbecher und -löffel

Medicine Cups and Spoons

Gobelets et cuillère à médicaments

Vasos y cuchara para medicamentos

Bicchieri e cucchiaio per medicinali

80.2300	30 cc
80.2302	50 cc



80.2300



80.2302

80.2310	6,8 x 1,8 cm
----------------	--------------



80.2310

80.2315	11 x 2 cm
----------------	-----------



80.2315

Zubehör · Accessories · Accessoires · Accesorios · Accessori

Instrumenttenablegeplatten
Instrument depositing trays
Plateaux pour déposer les instruments
Bandejas para instrumentos
Vassoi per strumenti

80.2400	210 x 160 x 10 mm
80.2401	240 x 180 x 10 mm
80.2402	310 x 150 x 10 mm
80.2406	310 x 210 x 10 mm
80.2407	400 x 270 x 20 mm
80.2408	420 x 280 x 10 mm

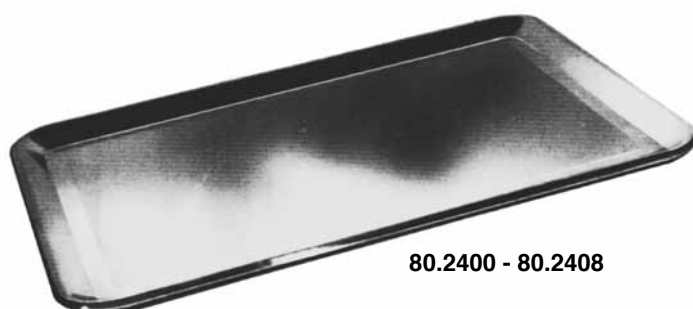

80.2400 - 80.2408

80.2430	230 x 155 x 30 mm
80.2432	300 x 175 x 30 mm
80.2434	300 x 175 x 40 mm
80.2436	350 x 240 x 36 mm
80.2438	400 x 300 x 50 mm



80.2400 - 80.2408

Instrumentenkästen
Instrument Boxes
Boîtes à Instruments
Cajas para instrumentos
Cestelli per strumenti

80.4100	16x10x 3 cm
80.4101	20x10x 5 cm
80.4102	22x15x 5 cm
80.4103	26x15x 5 cm
80.4104	30x20x 5 cm



80.4100 - 80.4104