

ARTERIENKLEMMEN, PRÄPARIERKLEMMEN
HEMOSTATIC- AND DISSECTING FORCEPS
PINCES HEMOSTATIQUES ET A PREPARATION
PINZAS HEMOSTATICAS Y PARA PREPARACIONES
PINZE EMOSTATICHE E PER PREPARAZIONE

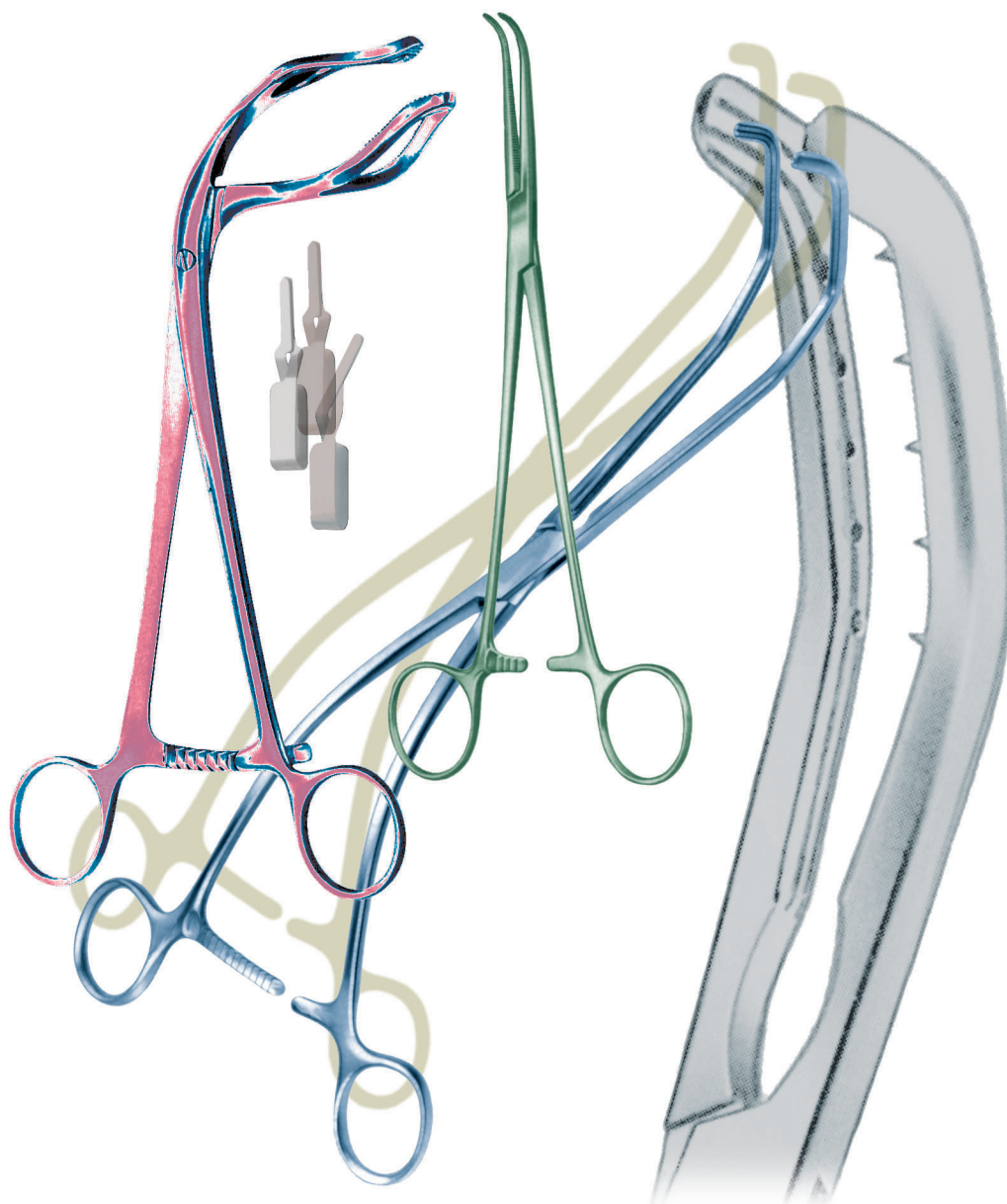

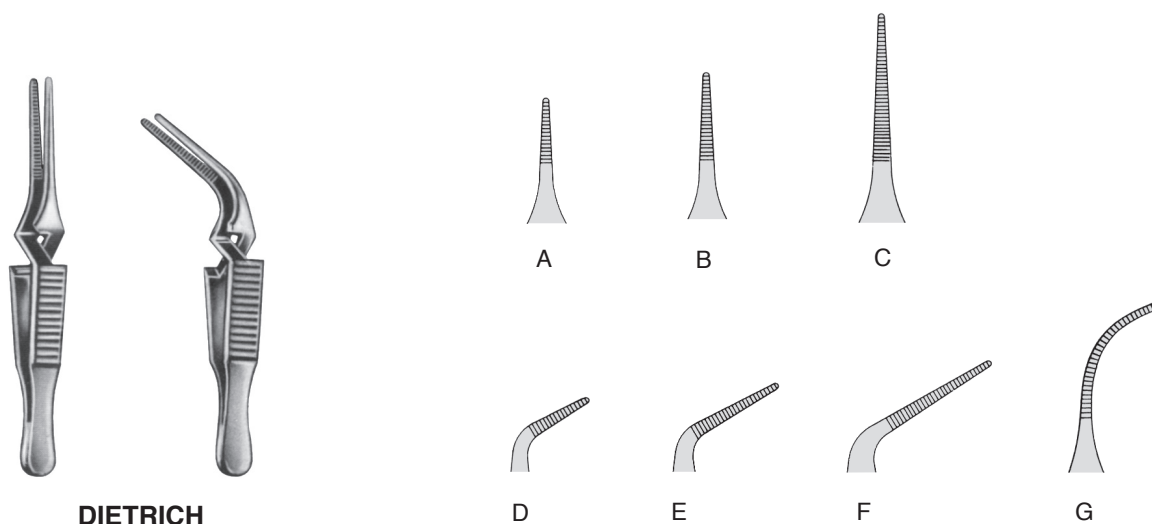

Artikel Item	Fig.	Gesamtlänge Overall length Longeur complet largo total Lunghezza total	Maullänge Jaw length longeur de mors largo de boca Lunghezza del morso	Gewicht Weight Poids Peso Peso	Schliessdruck Closing pressure Pression d'Occlusion Presión de cierre Pressione di chiusura
41.0030	A	50 mm	8 mm	3 g	80
41.0031	D	43 mm	8 mm	3 g	80
41.0032	B	53 mm	12 mm	3 g	80
41.0033	E	45 mm	12 mm	3 g	80
41.0034	C	60 mm	20 mm	3 g	80
41.0035	F	50 mm	20 mm	3 g	80
41.0037	G	54 mm	20 mm	3 g	80



CARREL
15.0098 8,5 cm



15.0100

HARTMANN
10 cm



15.0108
glattes Maul
smooth jaws
lisses
lisas
liscio



HARTMANN
15.0101 10 cm

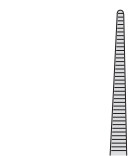

HARTMANN-MICRO
15.0102 10 cm



HARTMANN-MICRO
15.0103 10 cm



HARTMANN
15.0104 10 cm 1x2



HARTMANN
15.0105 10 cm 1x2

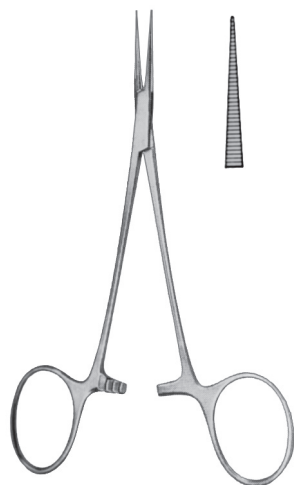

JACOBSON-MICRO
 15.0116 12,5 cm

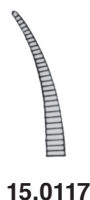

15.0117

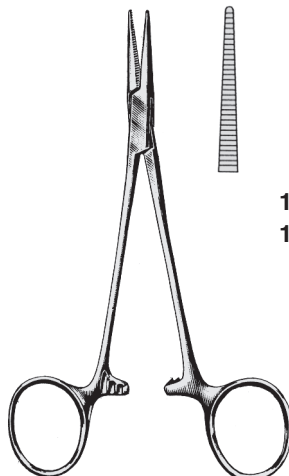

MOSQUITO
 15.0120 12,5 cm
 15.0120L 12,5 cm
 15.0124 14 cm

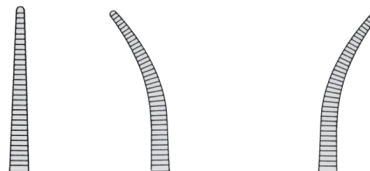

15.0121 12,5 cm
 15.0125 14 cm
 15.0121L

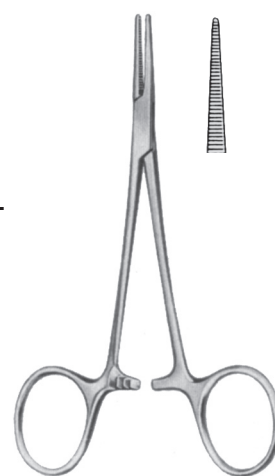

MICRO-MOSQUITO
 15.0122 12,5 cm

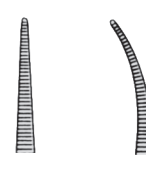

15.0123



MICRO-MOSQUITO
 15.0128 12 cm 1x2

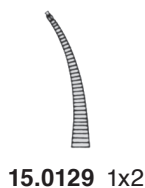

15.0129 1x2



MOSQUITO
 15.0126 12,5 cm 1x2
 15.0136 14 cm 1x2

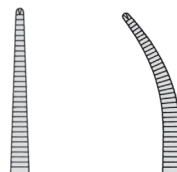

15.0127 12,5 cm 1x2
 15.0137 14 cm 1x2



MICRO-MOSQUITO
 15.0139 12,5 cm
 kreuzgerieft / cross-serrated
 rainures croisées
 estriada en forma de cruz
 striatura cruciforme

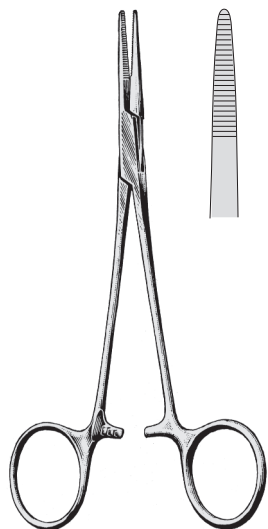

15.0131

PROVIDENCE-HOSPITAL
15.0130 14,5 cm

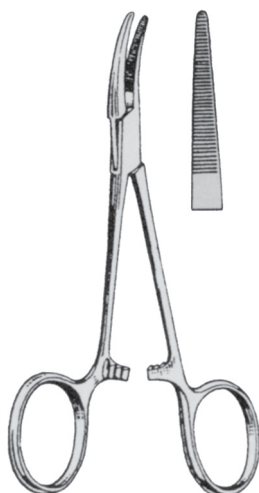

15.0181

DUNHILL
15.0180 12,5 cm

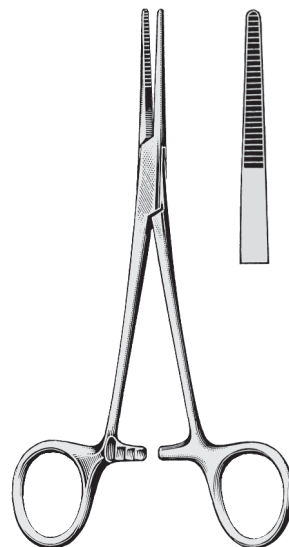

15.0201

KELLY
15.0200 14 cm



CRILE
15.0210 14 cm



15.0211



15.0212



15.0213



15.0214 1x2



15.0215 1x2

CRILE-BABY



DANDY-MOSQUITO
15.0218 12 cm



DANDY
14,5 cm

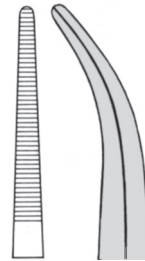

15.0220

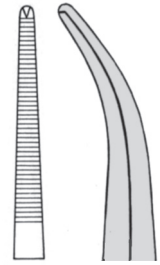

15.0222 1x2

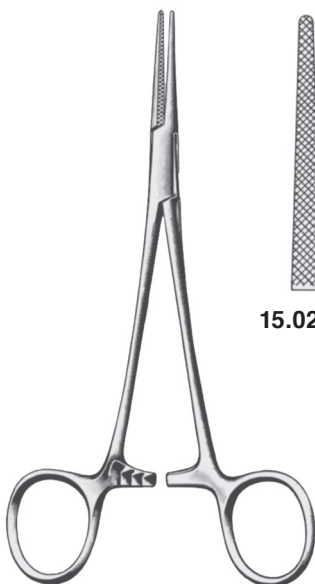

LOVELACE
15,5 cm



15.0224



15.0225 1x2

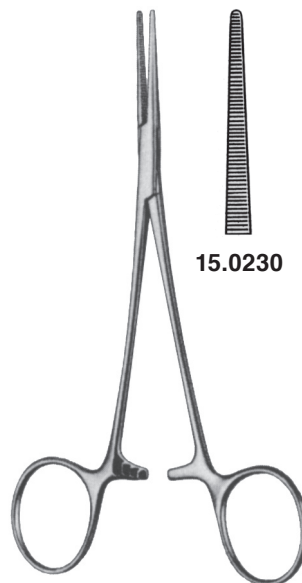

LERICHE
15 cm



15.0230



15.0231



15.0236 1x2

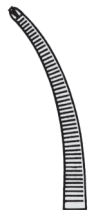

15.0237 1x2



15.0240

15.0241

RANKIN-KELLY
16 cm



15.0251

RANKIN-CRILE
15.0250 16 cm



15.0253
1x2

RANKIN-CRILE
15.0252 16 cm 1x2



COLLER-CRILE

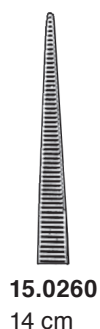

15.0260
14 cm

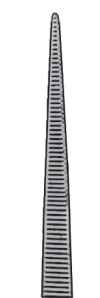

15.0262
16 cm

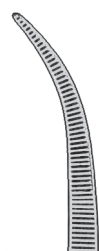

15.0261
14 cm

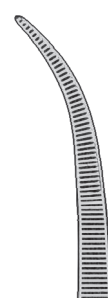

15.0263
16 cm

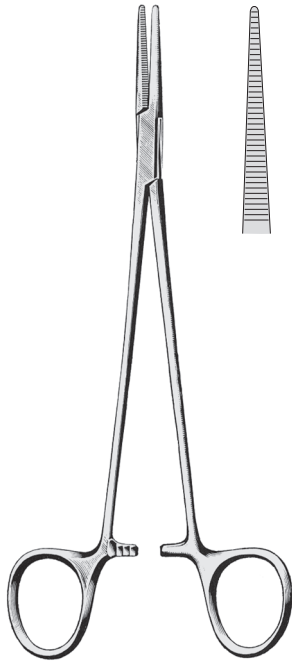

HALSTED

15.0300 18 cm
 15.0302 21 cm

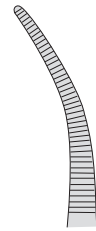

15.0301 18 cm
 15.0303 21 cm



15.0306 18 cm 1x2
 15.0308 21 cm 1x2

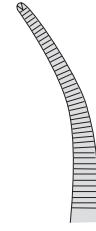

15.0307 18 cm 1x2
 15.0309 21 cm 1x2



ADSON-BABY
 15.0313 14 cm

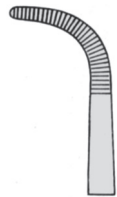

15.0315
 18 cm



ADSON
 15.0310 18,5 cm

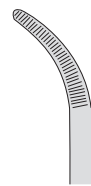

15.0311

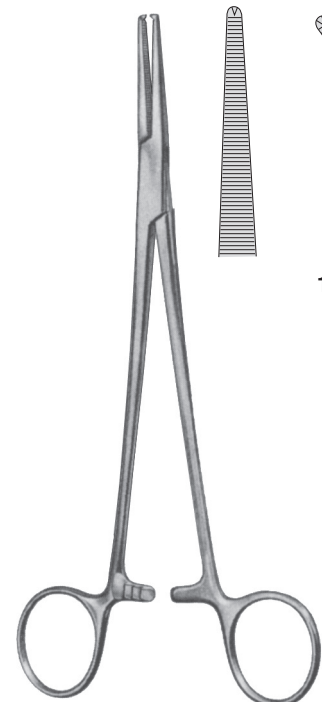

ADSON
 15.0316 18,5 cm 1x2

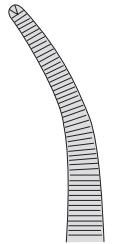

15.0317 1x2

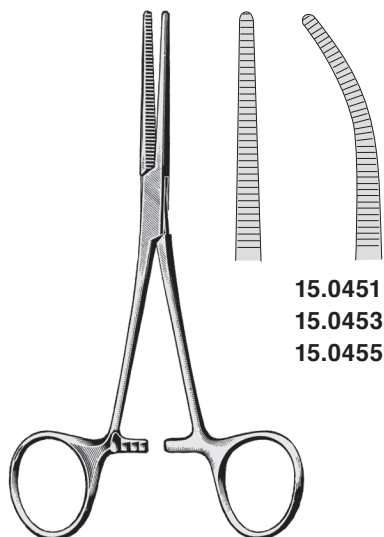

15.0451 13 cm
15.0453 14 cm
15.0455 16 cm

PEAN-FINO

15.0450 13 cm
15.0452 14 cm
15.0454 16 cm

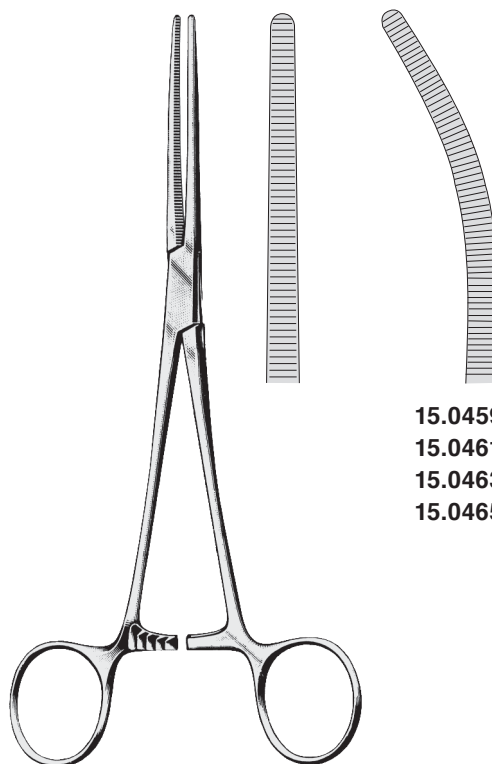

15.0459 13 cm
15.0461 14 cm
15.0463 16 cm
15.0465 18 cm

ROCHESTER-PEAN

15.0458 13 cm
15.0460 14 cm
15.0462 16 cm
15.0464 18 cm

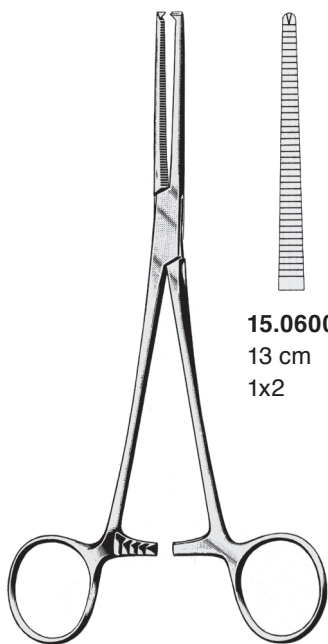

15.0600 13 cm 1x2
15.0601 13 cm 1x2
15.0602 14,5 cm 1x2
15.0603 14,5 cm 1x2
15.0604 16 cm 1x2
15.0605 16 cm 1x2

KOCHER

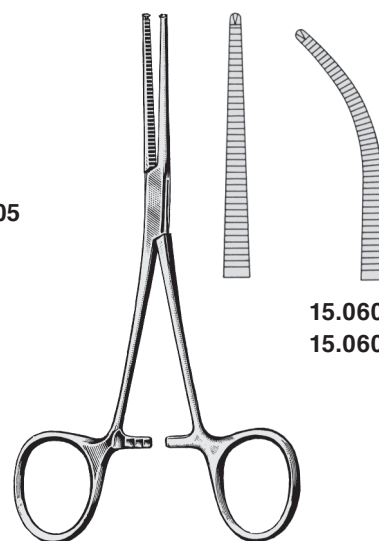

15.0607 14 cm
15.0609 16 cm

KOCHER-FINO

15.0606 14 cm
15.0608 16 cm

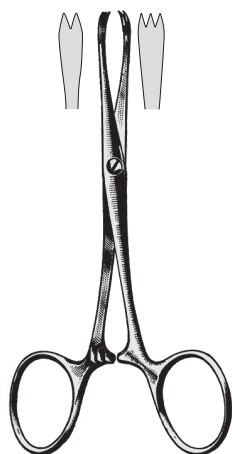

CHAPUT
15.1200 12 cm



TUFFIER
15.1204 13 cm



PENNINGTON
15.1300 15 cm
15.1302 20 cm



ALLIS-BABY
48.0004 13 cm, 4 x 5
48.0006 14 cm, 4 x 5



ALLIS

48.0010
15 cm, 4 x 5

48.0011
15 cm, 5 x 6
48.0014
19 cm, 5 x 6

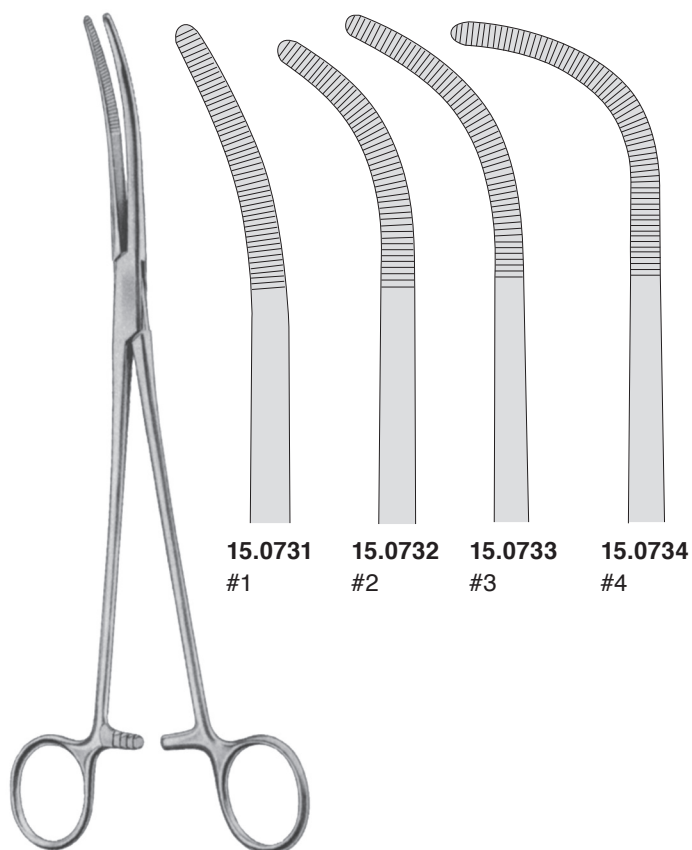

15.0731 #1
 15.0732 #2
 15.0733 #3
 15.0734 #4

RUMEL
 23 cm



15.0741 20 cm
 15.0743 24 cm
 15.0745 28 cm

KANTROWITZ

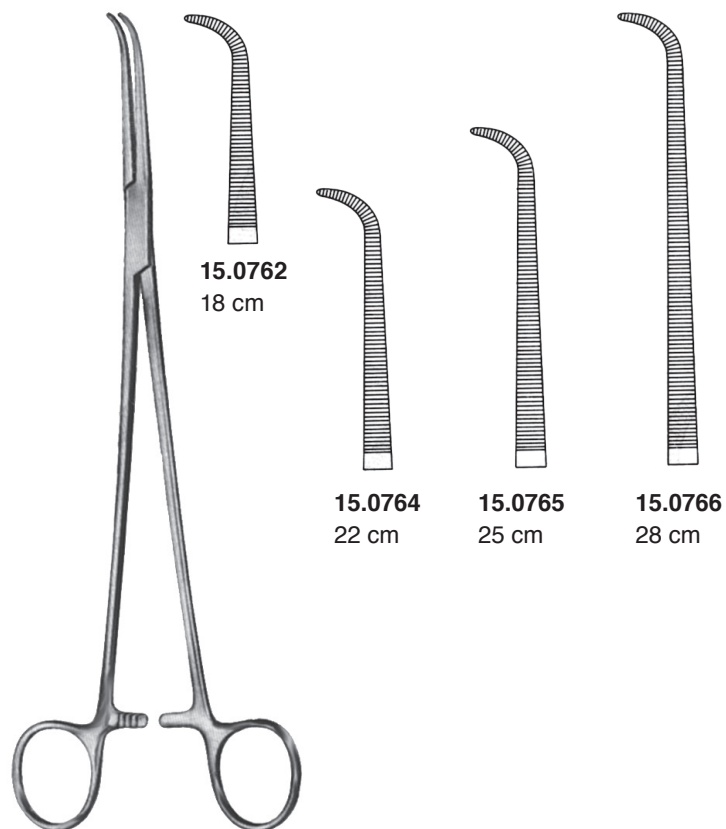

15.0762 18 cm
 15.0764 22 cm
 15.0765 25 cm
 15.0766 28 cm

GEMINI-MINI

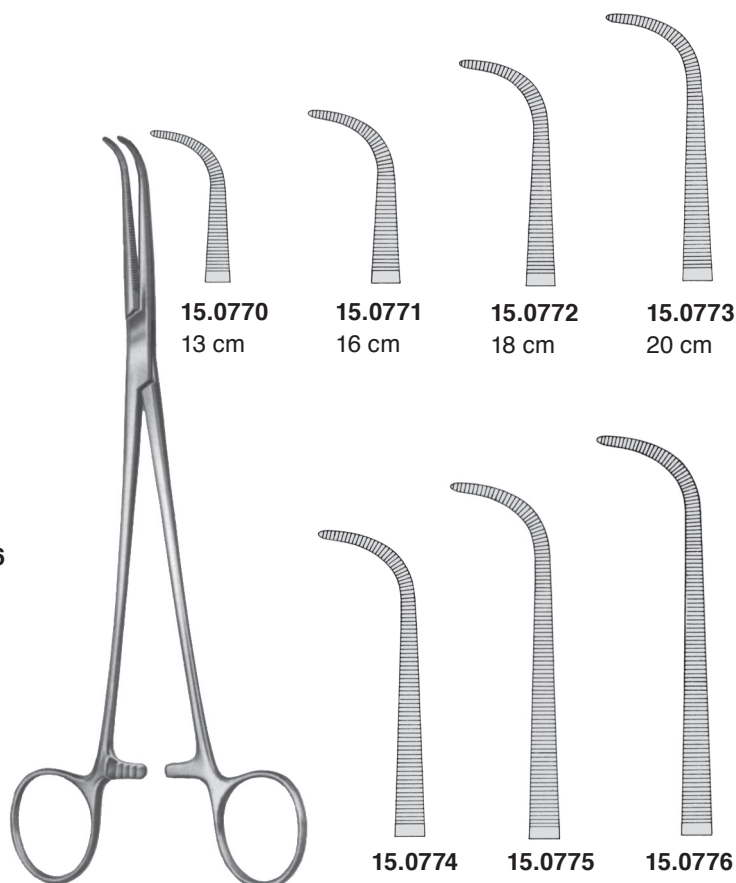

15.0770 13 cm
 15.0771 16 cm
 15.0772 18 cm
 15.0773 20 cm
 15.0774 23 cm
 15.0775 25 cm
 15.0776 28 cm

GEMINI

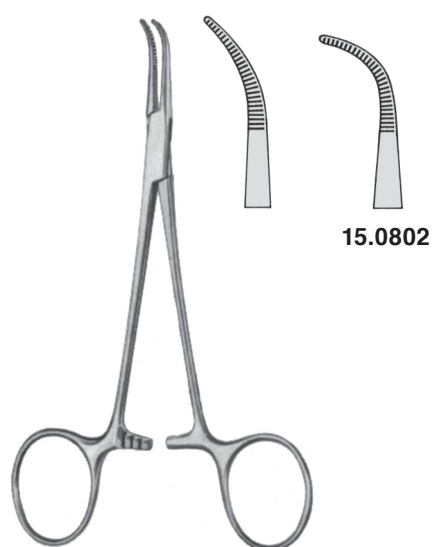

MIXTER-BABY
15.0801 14,5 cm



MIXTER-BABY
15.0803 18 cm

PRO-MED ist Ihnen behilflich bei der Zusammenstellung von Operationsbestecken für die verschiedensten Disziplinen. Fragen Sie nach unseren vorbereiteten OP-Bestecken.

For your convenience a wide variety of Suggested Operating Sets for most general and specialized procedures is available from **PRO-MED**. Please contact us or your local dealer.

PRO-MED vous propose de multiples compositions de boîtes opératoires multidisciplinaires. Demandez nos suggestions pour de nombreuses interventions.

PRO-MED le ayuda en componer varias cajas de instrumentos quirúrgicos. Pregunte por nuestro instrumental quirúrgico preparado.

Per la vostra comodità **PRO-MED** Vi aiuta nella raccolta di strumenti chirurgici per le varie discipline. Vi preghiamo di chiedere informazioni sui nostri set di strumenti chirurgici già preparati.

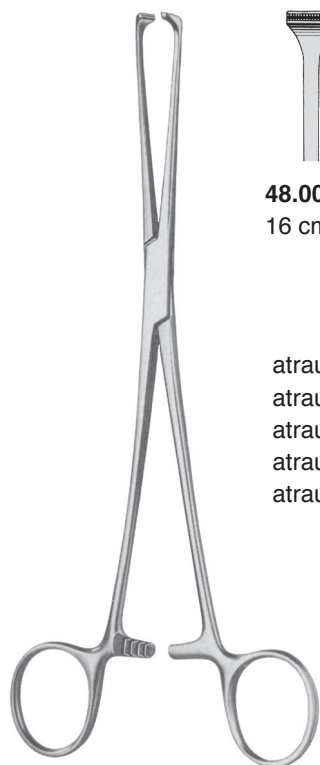

48.0020
16 cm

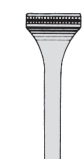

48.0024
20 cm

atraumatisch
 atraumatic
 atraumatique
 atraumática
 atraumatiche

ALLIS



ALLIS-ADAIR
48.0030 15,5 cm



JUDD-ALLIS
48.0032 15 cm
48.0034 19 cm
3 x 4

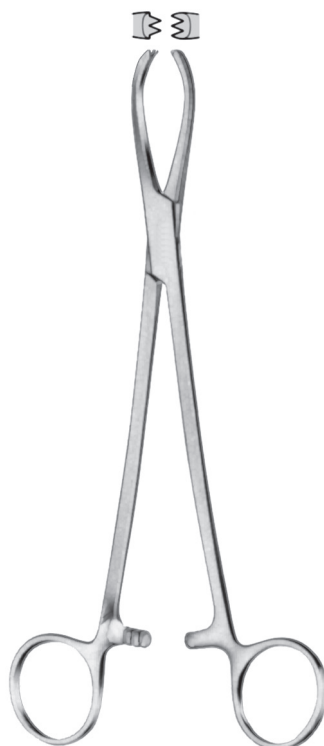

LITTLEWOOD
48.0035 19 cm
2 x 3



BOYS-ALLIS
48.0036 15 cm



BABCOCK

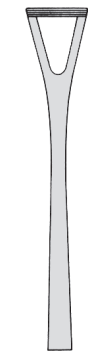

48.0062
16 cm

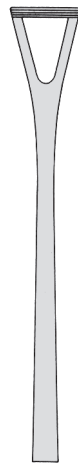

48.0064
18 cm



BABCOCK

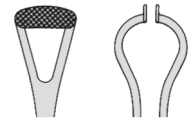

48.0072
16 cm

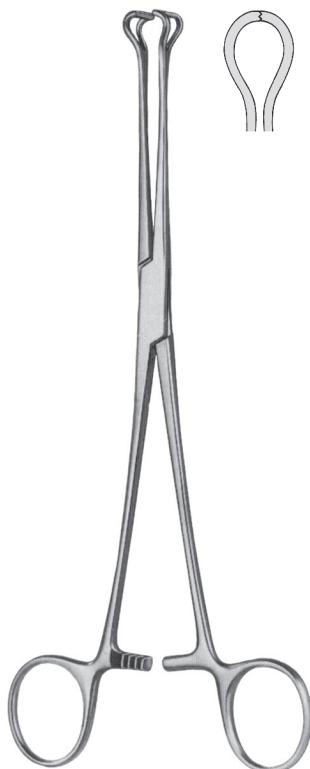

BABCOCK-DEBAKEY

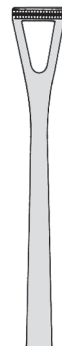

48.0082
16 cm

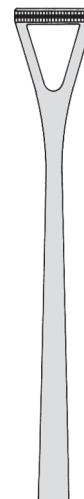

48.0086
20 cm



COLLIN
48.0089
14 cm



DUVAL

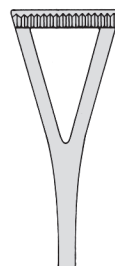

48.0090
18 cm / 14 mm
48.0092
20 cm / 14 mm

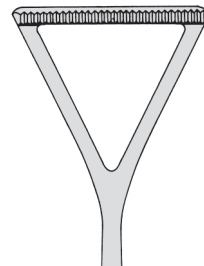

48.0094
20 cm / 25 mm
48.0098
23 cm / 25 mm



DUVAL



48.0099
20 cm / 15 mm

