

MIKROCHIRURGIE  
MICROSURGERY  
MICROCHIRURGIE  
MICROCIRUGIA  
MICROCHIRURGIA

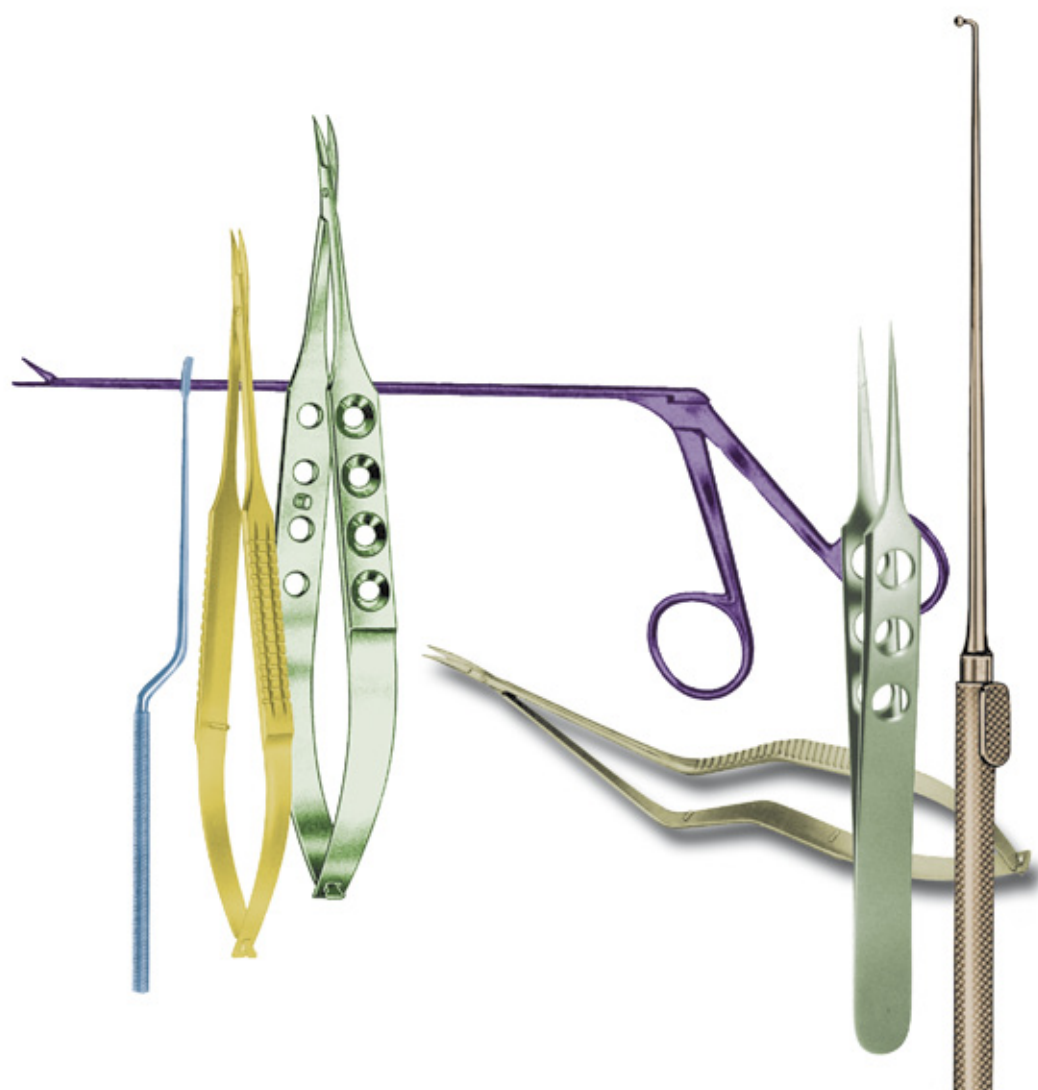

**PRO-MED** ist Ihnen behilflich bei der Zusammenstellung von Operationsbestecken für die verschiedensten Disziplinen. Fragen Sie nach unseren vorbereiteten OP-Bestecken.

For your convenience a wide variety of Suggested Operating Sets for most general and specialized procedures is available from **PRO-MED**. Please contact us or your local dealer.

**PRO-MED** vous propose de multiples compositions de boîtes opératoires multidisciplinaires. Demandez nos suggestions pour de nombreuses interventions.

**PRO-MED** le ayuda en componer varias cajas de instrumentos quirúrgicos. Pregunte por nuestro instrumental quirúrgico preparado.

Per la vostra comodità **PRO-MED** vi aiuta nella raccolta di strumenti chirurgici per le varie discipline. Vi preghiamo di chiedere informazioni sui nostri set di strumenti chirurgici già preparati.

Empfohlene Operationsbestecke für den Bereich "MIKROCHIRURGIE" (Details erhalten Sie über Ihren Fachhändler)

Suggested Instrument Sets for „MICROSURGERY“ (please ask your dealer for details)

Suggestions de boîtes opératoires pour le secteur "MICROCHIRURGIE". (Pour plus de détails veuillez contacter votre distributeur)

Cajas quirúrgicas para "MICROCHIRURGIA" (para detalles póngase en contacto con su distribuidor)

Strumenti raccomandati per "MICROCHIRURGIA" (per ulteriori informazioni, vi preghiamo di contattare il vostro rivenditore)

**SET 27.2500** HYPOPHYSECTOMY SET  
**SET 28.0001** MICRO SURGERY SET  
**SET 28.0100** MICRO VASCULAR SET  
**SET 28.0200** MICRO TUBULAR INSTRUMENTS SET

Mikro-Skalpellklingen und -griffe  
 Micro Scalpel Blades and Handles  
 Micro lames de bistouris et manches  
 Micro hojas de bisturi y mangos  
 Micro lame per bisturi e manici

in Packungen à 10 St.  
 in packages of 10 ea.  
 en boîtes de 10 pièces  
 en cajas de 10 c/u  
 in scatole di 10 pezzi



**12.0061** #61      **12.0062** #62      **12.0062S** #62S      **12.0065** #65      **12.0067** #67      **12.0069** #69

Griffe für Klingen  
 handles for blades  
 manches pour lames  
 mangos para hojas  
 manici per bisturi

12.0061 - 12.0069



**12.0180** 100 mm  
**12.0182** 125 mm  
**12.0184** 155 mm  
**12.0186** 180 mm  
**12.0188** 200 mm



**LANDOLD**  
**12.0153**  
 21 cm bajonett



**LANDOLD**  
**12.0157**  
 25 cm bajonett



**TROUTMAN**  
12.5000 9 cm



**TROUTMAN**  
12.5001 9 cm



**CASTROVIEJO**  
12.5010 13 cm / 8 mm  
12.5012 13 cm / 10 mm



**BARRAQUER**  
12.5020 11 cm

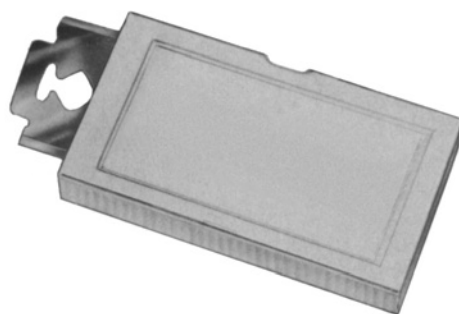

**12.5100**  
Packung = 10  
Package = 10  
Boîte = 10  
Cajita = 10  
Scatola = 10

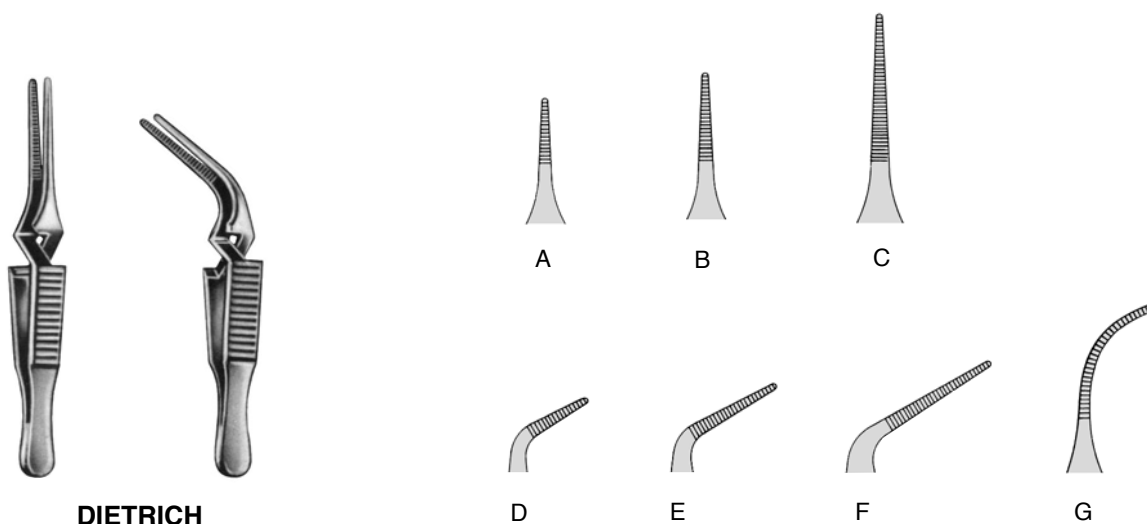

**DIETRICH**

Artikel Item	Fig.	Gesamtlänge Overall length Longeur complet largo total Lunghezza totale	Maullänge Jaw length longeur de mors largo de boca Lunghezza del morso	Gewicht Weight Poids Peso Peso	Schliessdruck Closing pressure Pression d'Occlusion Presión de cierre Pressione di chiusura
<b>41.0030</b>	A	50 mm	8 mm	3 g	80
<b>41.0031</b>	D	43 mm	8 mm	3 g	80
<b>41.0032</b>	B	53 mm	12 mm	3 g	80
<b>41.0033</b>	E	45 mm	12 mm	3 g	80
<b>41.0034</b>	C	60 mm	20 mm	3 g	80
<b>41.0035</b>	F	50 mm	20 mm	3 g	80
<b>41.0037</b>	G	54 mm	20 mm	3 g	80



**CARREL**  
 15.0098 8,5 cm

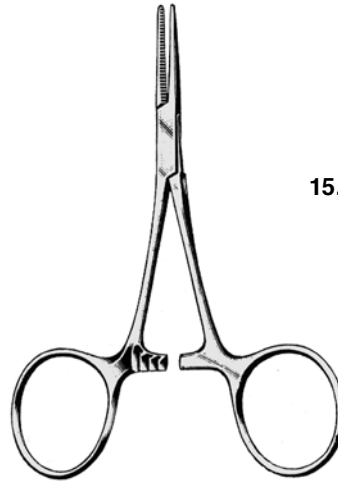

**HARTMANN**  
 10 cm



**15.0108**  
 glattes Maul  
 smooth jaws  
 lisses  
 lisas  
 liscio



**HARTMANN**  
 15.0101 10 cm



**HARTMANN-MICRO**  
 15.0103 10 cm



**HARTMANN**  
 15.0104 10 cm 1x2



**HARTMANN**  
 15.0105 10 cm 1x2

## TITANIUM

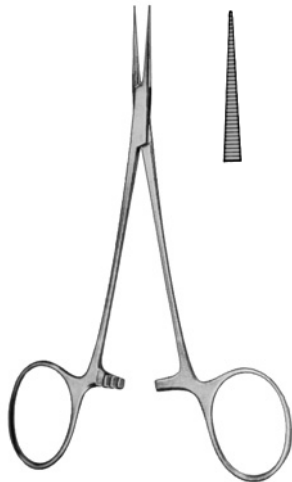

**JACOBSON-MICRO**  
15.0116 12,5 cm

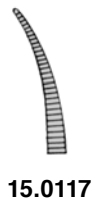

15.0117



**MOSQUITO**  
15.0120 12,5 cm  
15.0120T 12,5 cm  
15.0120L 12,5 cm  
15.0124 14 cm

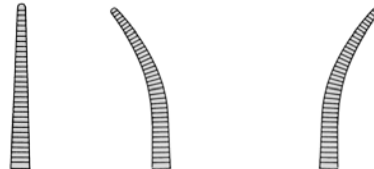

15.0121 12,5 cm  
15.0121T 12,5 cm  
15.0125 14 cm  
15.0121L

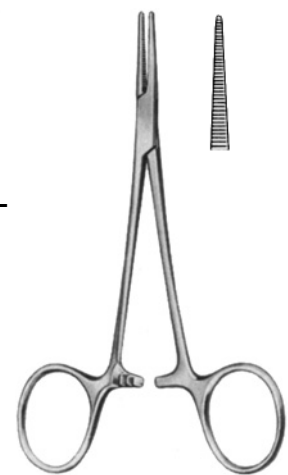

**MICRO-MOSQUITO**  
15.0122 12,5 cm



15.0123



**MICRO-MOSQUITO**  
15.0128 12 cm 1x2



15.0129 1x2



**MOSQUITO**  
15.0126 12,5 cm 1x2  
15.0126T 12,5 cm 1x2  
15.0136 14,0 cm 1x2



15.0127 12,5 cm 1x2  
15.0127T 12,5 cm 1x2  
15.0137 14,0 cm 1x2



**MICRO-MOSQUITO**  
15.0139 12,5 cm  
kreuzgerieft / cross-serrated  
rainures croisées  
estriada en forma de cruz  
striatura cruciforme

**TITANIUM**

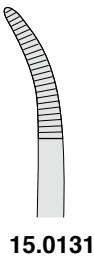
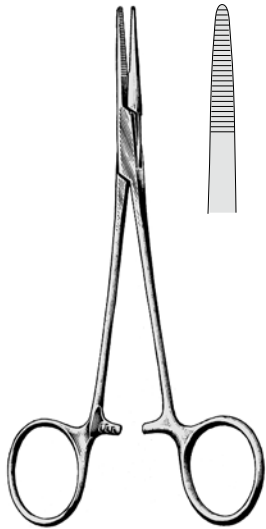

15.0131

**PROVIDENCE-HOSPITAL**  
 15.0130 14,5 cm

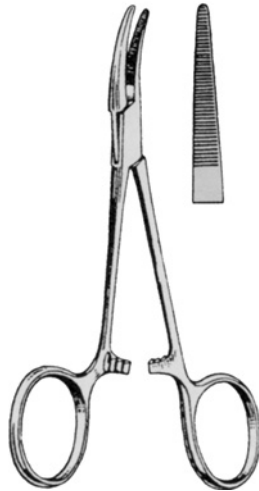

15.0181

**DUNHILL**  
 15.0180 12,5 cm

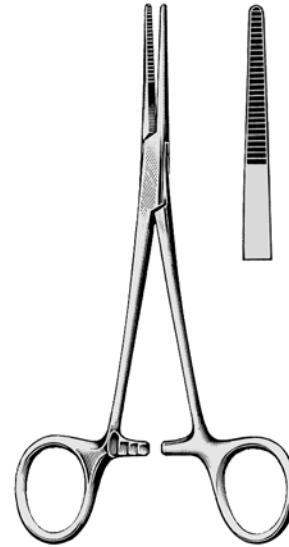

15.0201  
 15.0201T

**KELLY**  
 15.0200 14 cm  
 15.0200T 14 cm



**CRILE**  
 15.0210 14 cm  
 15.0210T 14 cm



15.0211  
 15.0211T



15.0212



15.0213

**CRILE-BABY**



15.0214 1x2



15.0215 1x2





**DANDY-MOSQUITO**  
15.0218 12 cm

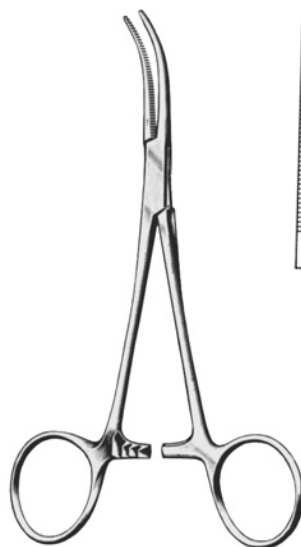

**DANDY**  
14,5 cm

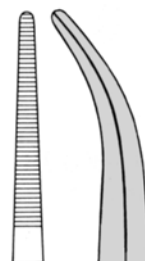

15.0220

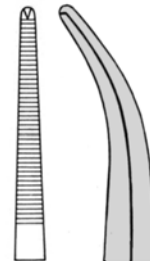

15.0222 1x2

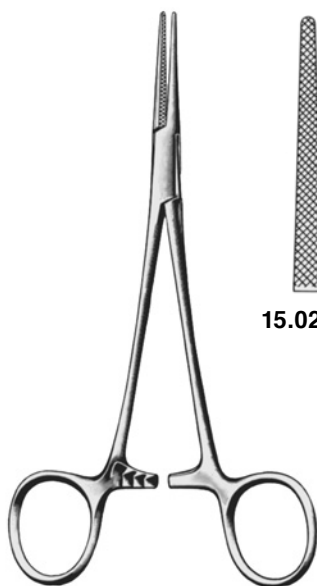

**LOVELACE**  
15,5 cm



15.0224



15.0225 1x2

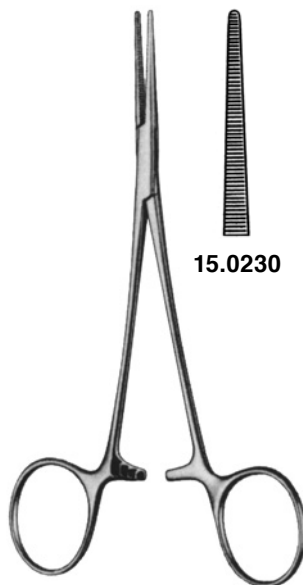

**LERICHE**  
15 cm

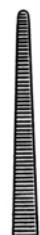

15.0230



15.0231



15.0236 1x2



15.0237 1x2



15.0240

15.0241

**RANKIN-KELLY**  
16 cm



15.0251

**RANKIN-CRILE**  
15.0250 16 cm



15.0253  
1x2

**RANKIN-CRILE**  
15.0252 16 cm 1x2



15.0260  
14 cm



15.0262  
16 cm



15.0261  
14 cm



15.0263  
16 cm

**COLLER-CRILE**

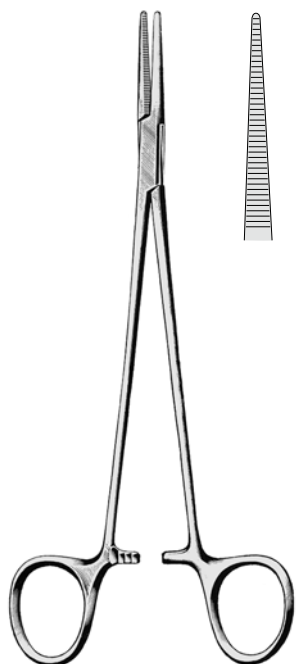

**HALSTED**

15.0300 18 cm  
 15.0302 21 cm

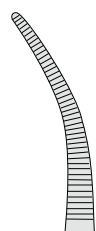

15.0301 18 cm  
 15.0303 21 cm



15.0306 18 cm 1x2  
 15.0308 21 cm 1x2

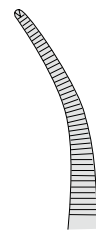

15.0307 18 cm 1x2  
 15.0309 21 cm 1x2



**ADSON-BABY**  
 15.0313 14 cm

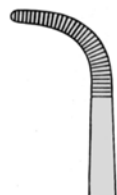

15.0315  
 18 cm



**ADSON**  
 15.0310 18,5 cm

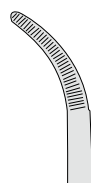

15.0311

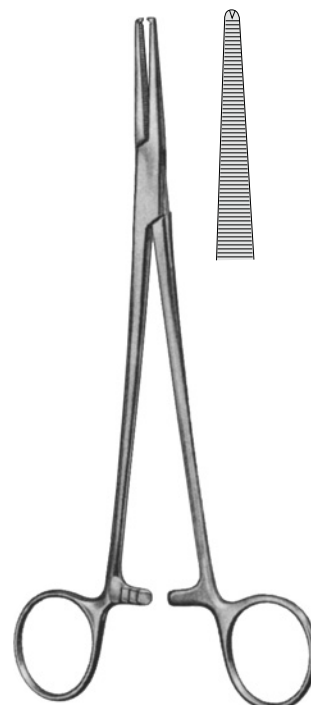

**ADSON**  
 15.0316 18,5 cm 1x2

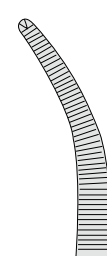

15.0317 1x2

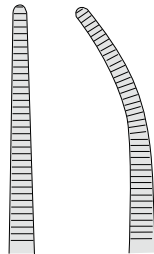
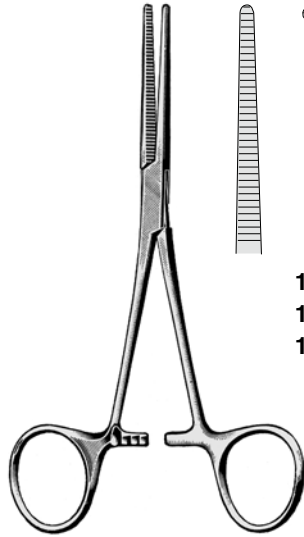

**15.0451** 13 cm  
**15.0453** 14 cm  
**15.0455** 16 cm

**PEAN-FINO**

**15.0450** 13 cm  
**15.0452** 14 cm  
**15.0454** 16 cm

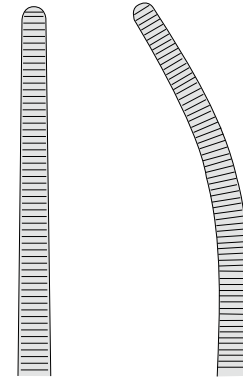
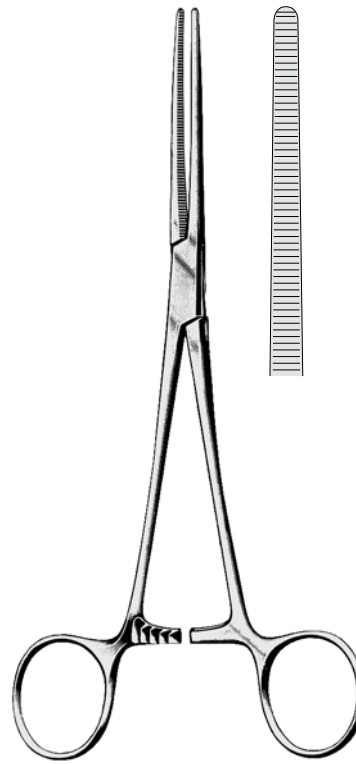

**15.0459** 13 cm  
**15.0461** 14 cm  
**15.0463** 16 cm  
**15.0465** 18 cm

**ROCHESTER-PEAN**

**15.0458** 13 cm  
**15.0460** 14 cm  
**15.0462** 16 cm  
**15.0464** 18 cm

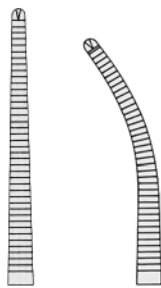
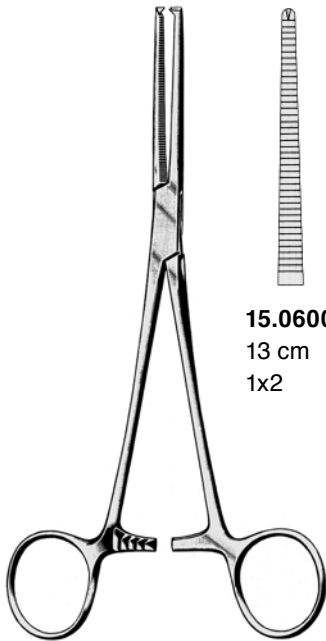

**15.0600**  
 13 cm  
 1x2

**15.0601**  
 13 cm  
 1x2



**15.0602**  
 14,5 cm  
 1x2



**15.0603**  
 14,5 cm  
 1x2



**15.0604**  
 16 cm  
 1x2



**15.0605**  
 16 cm  
 1x2

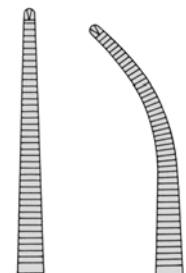
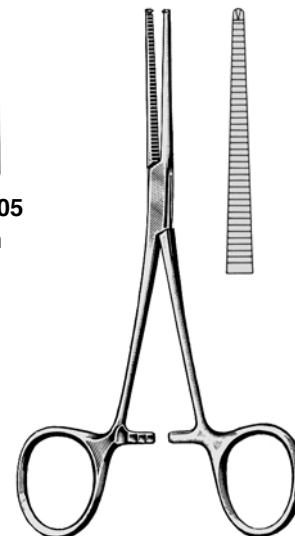

**15.0607** 14 cm  
**15.0609** 16 cm

**KOCHER**

**KOCHER-FINO**

**15.0606** 14 cm  
**15.0608** 16 cm

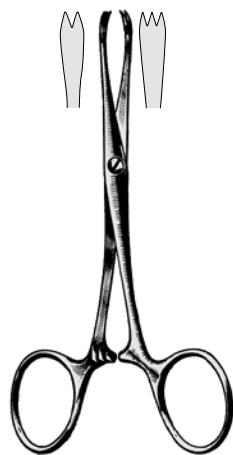

**CHAPUT**  
15.1200 12 cm

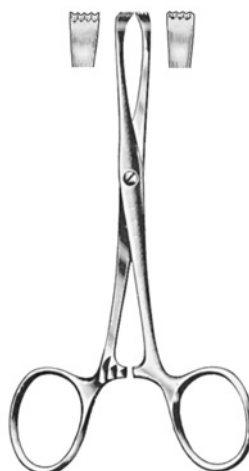

**TUFFIER**  
15.1204 13 cm



**PENNINGTON**  
15.1300 15 cm  
15.1302 20 cm



**ALLIS-BABY**  
48.0004 13 cm, 4 x 5  
48.0006 14 cm, 4 x 5



**ALLIS**

  
**48.0010**  
15 cm, 4 x 5

  
**48.0011**  
15 cm, 5 x 6  
**48.0014**  
19 cm, 5 x 6

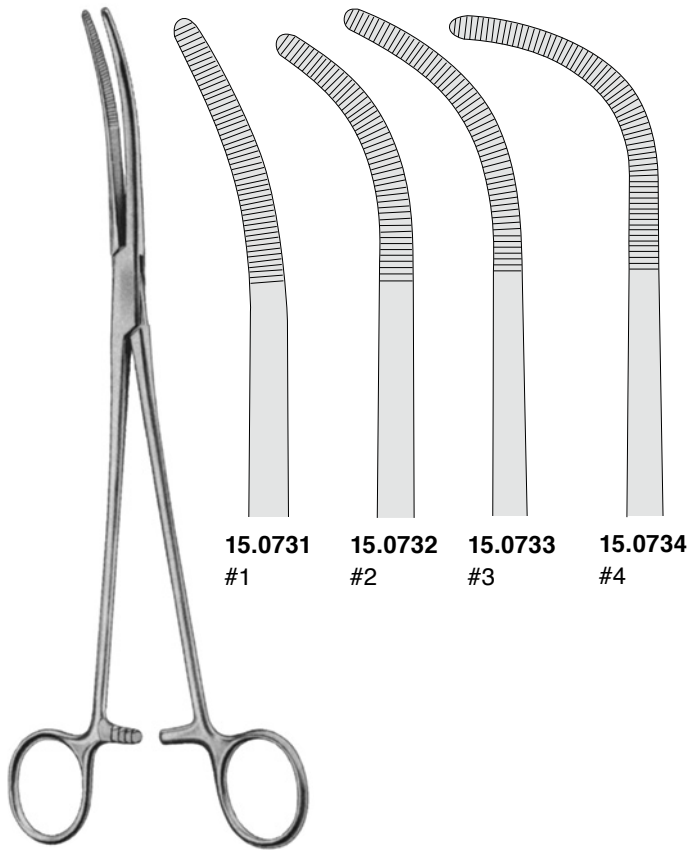

15.0731 #1  
 15.0732 #2  
 15.0733 #3  
 15.0734 #4

**RUMEL**  
 23 cm



15.0741 20 cm  
 15.0743 24 cm  
 15.0745 28 cm

**KANTROWITZ**

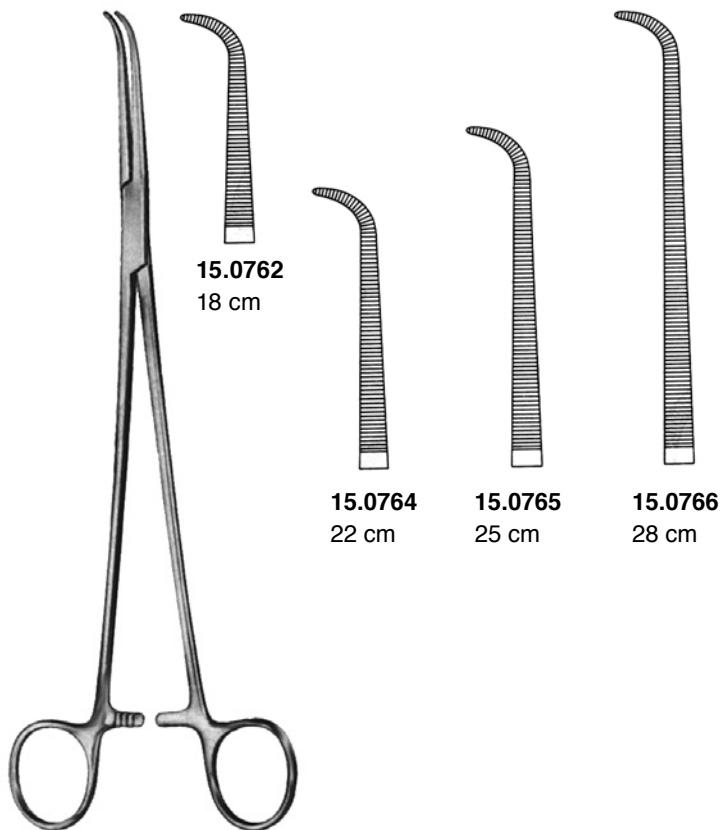

15.0762 18 cm

15.0764 22 cm

15.0765 25 cm

15.0766 28 cm

**GEMINI-MINI**

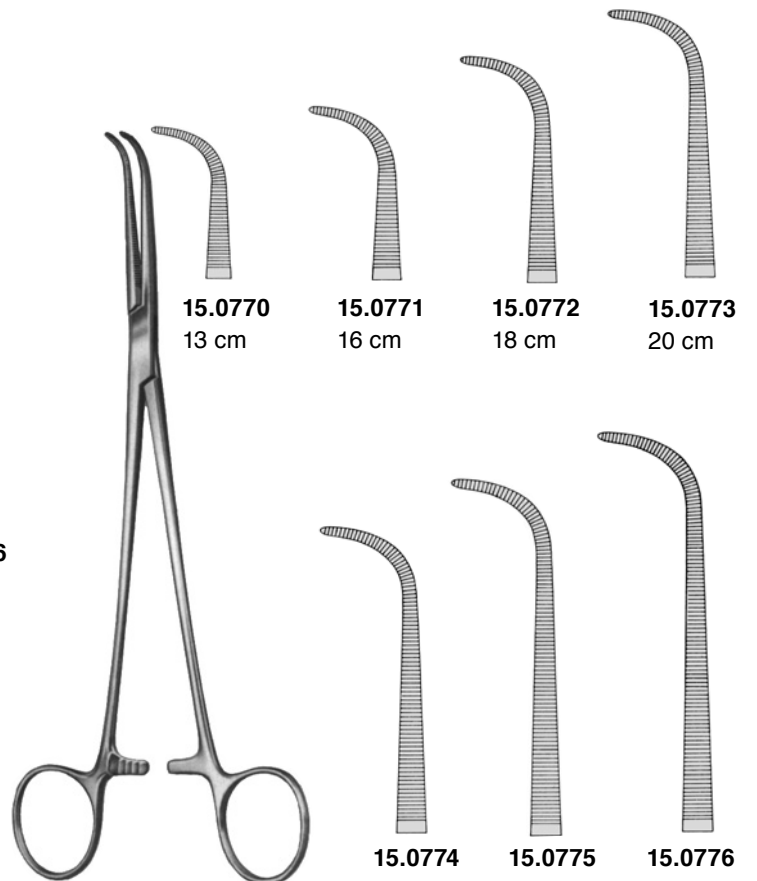

15.0770 13 cm

15.0771 16 cm

15.0772 18 cm

15.0773 20 cm

15.0774 23 cm

15.0775 25 cm

15.0776 28 cm

**GEMINI**

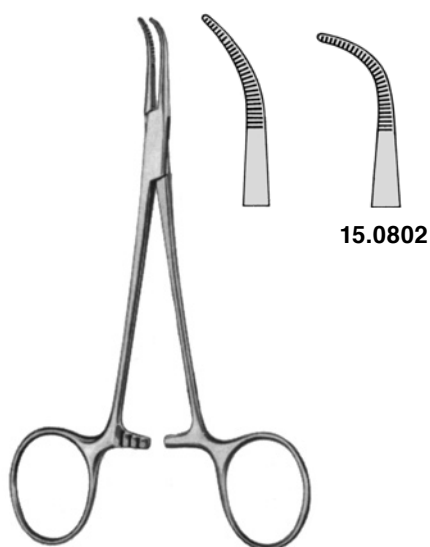

**MIXTER-BABY**  
15.0801 14,5 cm



**MIXTER-BABY**  
15.0803 18 cm

**PRO-MED** ist Ihnen behilflich bei der Zusammenstellung von Operationsbestecken für die verschiedensten Disziplinen. Fragen Sie nach unseren vorbereiteten OP-Bestecken.

For your convenience a wide variety of Suggested Operating Sets for most general and specialized procedures is available from **PRO-MED**. Please contact us or your local dealer.

**PRO-MED** vous propose de multiples compositions de boîtes opératoires multidisciplinaires. Demandez nos suggestions pour de nombreuses interventions.

**PRO-MED** le ayuda en componer varias cajas de instrumentos quirúrgicos. Pregunte por nuestro instrumental quirúrgico preparado.

Per la vostra comodità **PRO-MED** Vi aiuta nella raccolta di strumenti chirurgici per le varie discipline. Vi preghiamo di chiedere informazioni sui nostri set di strumenti chirurgici già preparati.



**28.2110**  
15,5 cm

**VANNAS-MIKRO**



**28.2111**  
15,5 cm

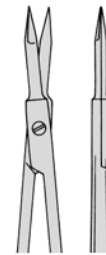

**28.2112**  
18,5 cm

**VANNAS-MIKRO**

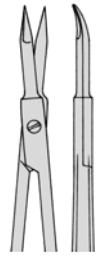

**28.2113**  
18,5 cm

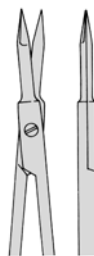

**28.2114**  
23 cm

**VANNAS-MIKRO**

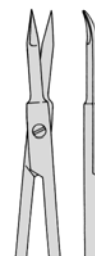

**28.2115**  
23 cm





**28.2100** 12,5 cm / Ø 7 mm  
gerade  
straight  
droit  
recto  
retto

**28.2101** 12,5 cm / Ø 7 mm  
gebogen  
curved  
courbe  
curvo  
curvo

VANNAS-MIKRO



**28.2102**  
15 cm  
Ø 8 mm  
**28.2104**  
18cm



**28.2103**  
15 cm  
Ø 8 mm  
**28.2105**  
18 cm

VANNAS-MIKRO



**28.2122**  
15 cm / Ø 8 mm  
gerade / straight /  
droit / recto / retto



**28.2123**  
15 cm / Ø 8 mm  
gebogen / curved /  
courbe / curvo /  
curvo



**28.2133**  
15 cm / Ø 8 mm  
gebogen / curved /  
courbe / curvo /  
curvo  
  
stumpf / blunt /  
mousses / romas /  
smusso



**28.2120**  
12,5 cm / Ø 7mm  
gerade / straight  
droit / recto / retto



**28.2121**  
12,5 cm / Ø 7 mm  
gebogen / curved  
courbe / curvo / curvo



**28.2124**  
18 cm / Ø 8 mm  
gerade / straight  
droit / recto / retto

**28.2125**  
18 cm / Ø 8 mm  
gebogen / curved  
courbe / curvo / curvo



**28.2150 (GYN)**  
18 cm / Ø 8 mm  
gerade / straight  
droit / recto / retto

**28.2151 (GYN)**  
18 cm / Ø 8 mm  
gebogen / curved  
courbe / curvo / curvo



**28.2200**  
18 cm 25°



**28.2201**  
18 cm 45°



**28.2202**  
18 cm 60°

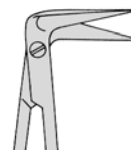

**28.2203**  
18 cm 90°

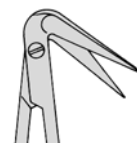

**28.2204**  
18 cm 125°



**ARTERIOTOMY**



**28.2210**  
18 cm 25°



**28.2211**  
18 cm 45°



**28.2212**  
18 cm 60°



**28.2213**  
18 cm 90°

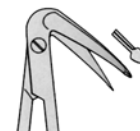

**28.2214**  
18 cm 125°

mit 1 geknöpften Blatt / 1 probe-pointed blade / avec 1 lame boutonée / con una punta botonada / con 1 lama abbottonata

**TITANIUM**

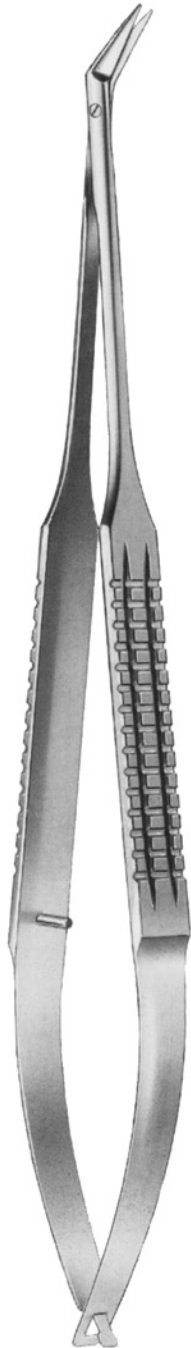

18 cm



28.2460  
**28.2460T**  
 25°



28.2470  
**28.2470T**  
 25°



28.2461  
**28.2461T**  
 45°



28.2471  
**28.2471T**  
 45°



28.2462  
**28.2462T**  
 60°



28.2472  
**28.2472T**  
 60°



28.2463  
**28.2463T**  
 90°



28.2473  
**28.2473T**  
 90°



28.2464  
**28.2464T**  
 125°



28.2474  
**28.2474T**  
 125°

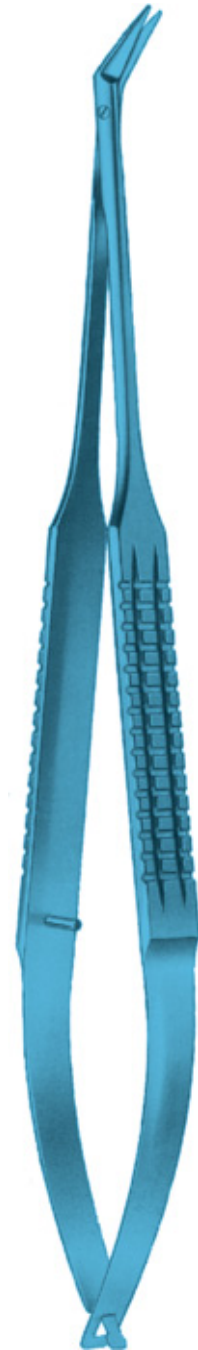

18 cm

mit 1 geknöpften Blatt  
 1 probe-pointed blade  
 1 lame boutonée  
 1 punta botonada  
 1 lame abbottonata



18 cm

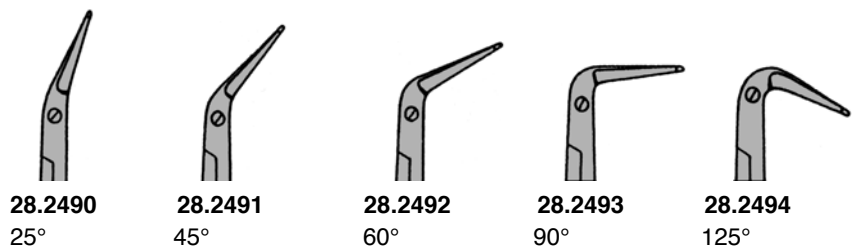
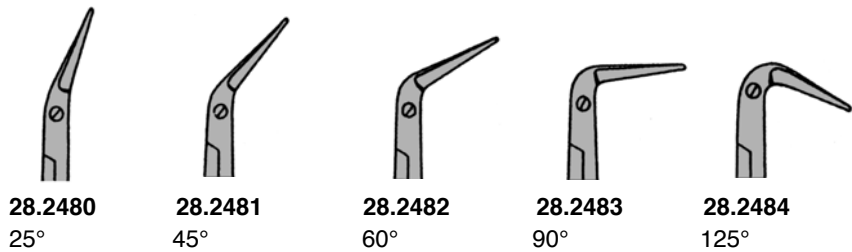

mit 1 geknöpften Blatt / 1 probe-pointed blade  
avec 1 lame boutonée / con una punta botonada / con 1 lama abbottonata

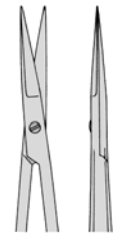

28.2220



28.2221

**JACOBSON**  
16 cm

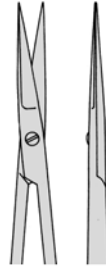

28.2222



28.2223



28.2225

**JACOBSON**  
19 cm



**MILLES**  
16 cm



28.2230



28.2231

gezahnt  
serrated  
dentelées  
dentada  
dentate



18,5 cm

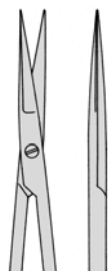

28.2310

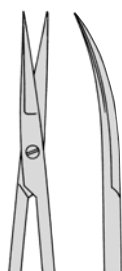

28.2311

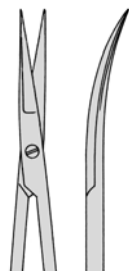

28.2313

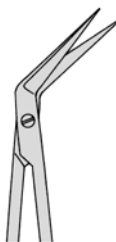

28.2315



23 cm



28.2350



28.2351

Venenschere  
Vein Scissors  
Ciseaux pour veines  
Tijera para venas  
Forbice per vene

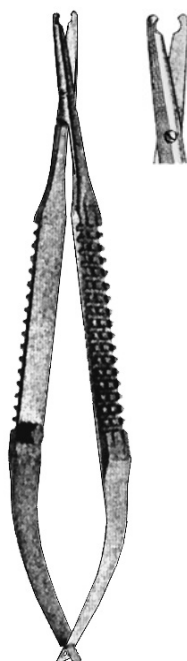

**BIEMER**  
**28.2400**  
13 cm

TITANIUM

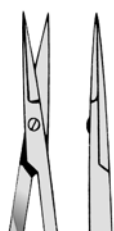
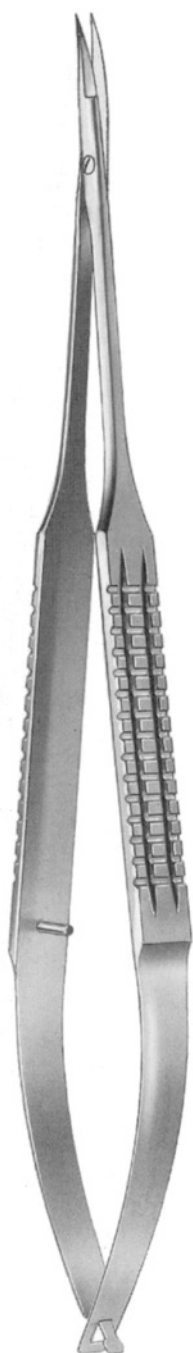

28.2560  
28.2560T

15 cm

28.2562  
28.2562T

18 cm

28.2564  
28.2564T

21 cm

28.2566  
23 cm



28.2561  
28.2561T

15 cm

28.2563  
28.2563T

18 cm

28.2565  
28.2565T

21 cm

28.2567  
23 cm







**28.2600** 16,5 cm  
**28.2602** 20,0 cm



**28.2601** 16,5 cm  
**28.2603** 20,0 cm



**28.2605** 20,0 cm



**28.2608** 20,0 cm



**28.2609** 20,0 cm



**28.2620** 22,5 cm  
**28.2622** 22,5 cm

gezahnt  
 serrated  
 dentelées  
 dentada  
 dentate



**28.2623** 22,5 cm  
**28.2625** 24,5 cm



**28.2624** 22,5 cm



**28.2628** 22,5 cm



**28.2629** 22,5 cm



**28.2640** 22,5 cm



**28.2641** 22,5 cm

**VANNAS**

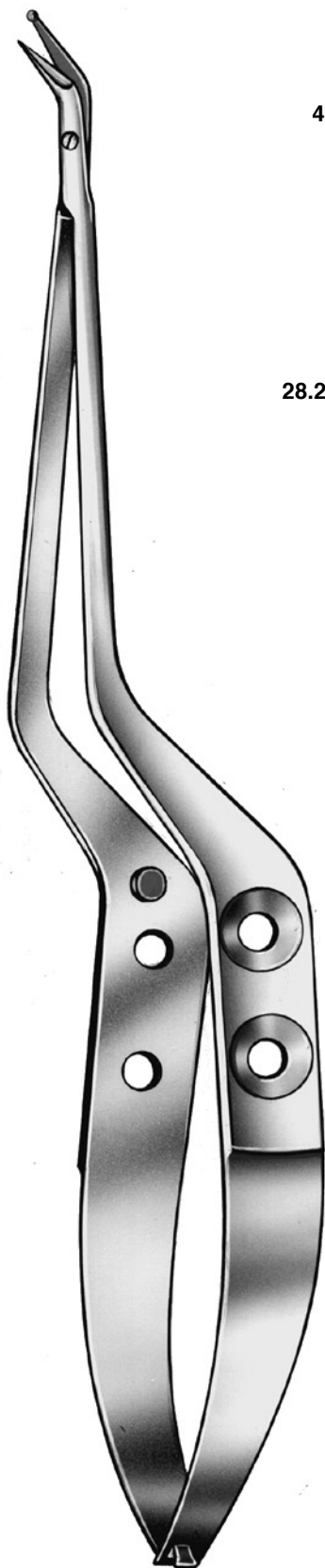

NAGEL

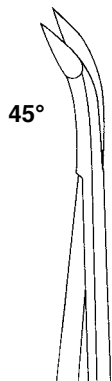

45°

28.2656 20,0 cm

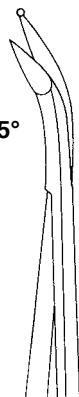

45°

28.2657 20,0 cm

geknöpft  
button-end  
boutonée  
abotonada  
con 1 lama abbottonata



125°

28.2659 20,0 cm

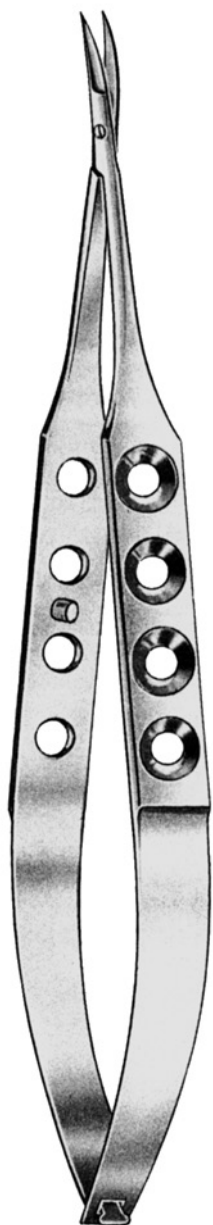

**VANNAS**  
 28.2714 12 cm  
 28.2718 16 cm



**VANNAS**  
 28.2715 12 cm  
 28.2719 16 cm



**VANNAS**  
 28.2711 12 cm



**YASARGIL**  
 28.2712 12 cm  
 28.2716 16 cm  
 28.2722 18,5 cm



**YASARGIL**  
 28.2713 12 cm  
 28.2717 16 cm  
 28.2723 18,5 cm

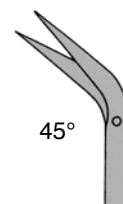

**POTTS-YASARGIL**  
 28.2724 18,5 cm



**MILLES**  
 28.2720 16 cm

gezahnt/serrated  
 dentelés/dentada  
 dentata



**MILLES**  
 28.2721 16 cm

gezahnt/serrated  
 dentelés/dentada  
 dentata















**BIEMER**  
 28.2728 13 cm

Venenschere  
 Vein Scissors  
 Ciseaux pour veines  
 Tijera para venas  
 Forbice per vene



17,5 cm

	Mikro-Scheren micro-scissors micro-ciseaux micro-tijeras micro-forbici	Mikro-Scheren fein micro-scissors fine micro-ciseaux fins micro-tijeras fino micro-forbici fini
gerade straight droites recta rette	 <b>28.4010</b>	 <b>28.4040</b>
gerade horizontal straight horizontal coupant horizontal recta horizontal rette orizzontale	 <b>28.4012</b>	 <b>28.4042</b>
aufgebogen curved up courbe vers le haut curva hacia arriba curve in alto	 <b>28.4013</b>	 <b>28.4043</b>
aufgebogen horizontal curved up horizontal coupant horizontal, courbe sur le plat curva hacia arriba horizontal curve in alto orizzontale	 <b>28.4015</b>	 <b>28.4045</b>
nach rechts gebogen curved to right courbe à droit curva a la derecha curve destra	 <b>28.4017</b>	 <b>28.4047</b>
nach links gebogen curved to left courbe à gauche curva a la izquierda curve sinistra	 <b>28.4019</b>	 <b>28.4049</b>
gerade 8 mm straight 8 mm droites 8 mm recta 8 mm retta 8 mm	 <b>28.4020</b>	

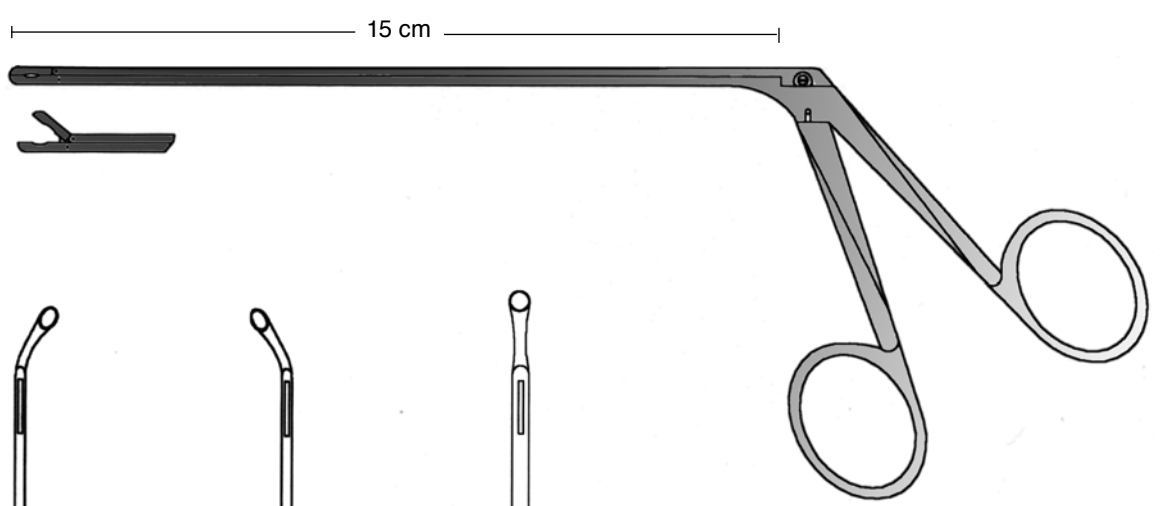
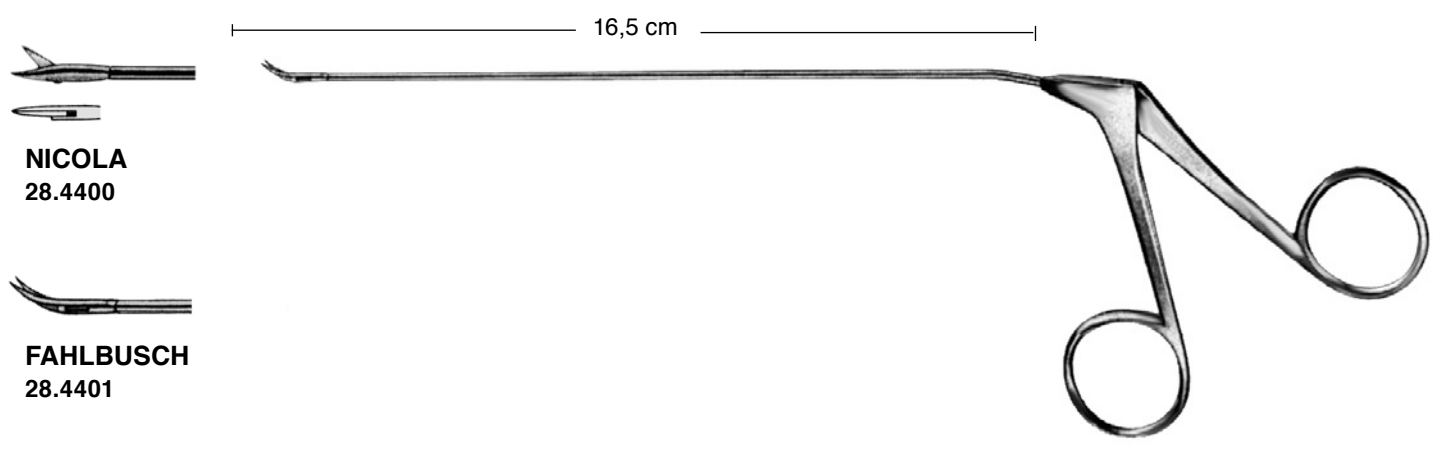
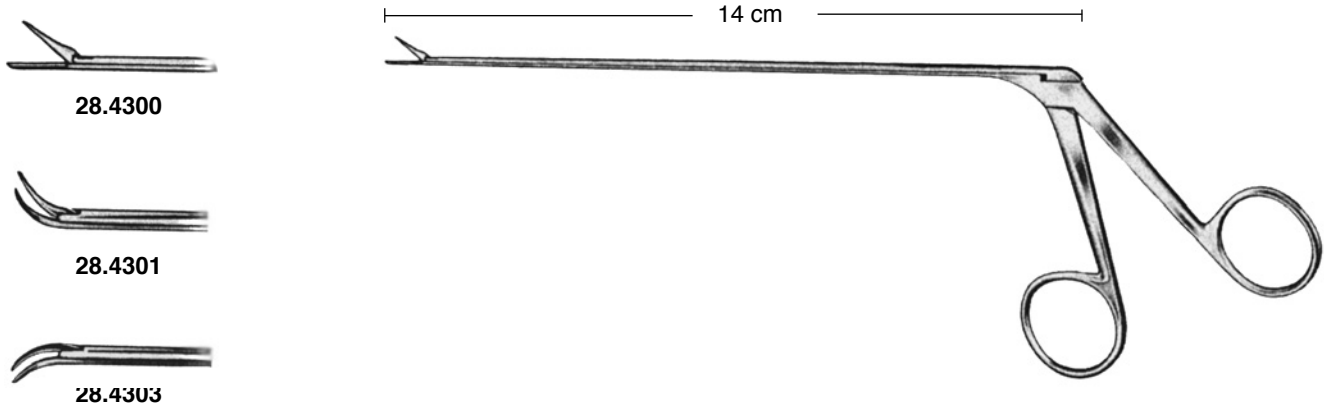

- |  |  |  |  |
|--|--|--|--|
|  |  |  |  |
| <b>28.0800</b><br>Ø 1 mm<br>gerade<br>straight<br>droite<br>recto<br>retto | <b>28.0801</b><br>Ø 1 mm<br>nach rechts gebogen<br>curved right<br>courbe à droite<br>curva a la derecha<br>curvo a destra | <b>28.0803</b><br>Ø 1 mm<br>nach links gebogen<br>curved right<br>courbe à gauche<br>curva a la izquierda<br>curvo in sinistra | <b>28.0804</b><br>Ø 2 mm<br>gerade<br>straight<br>droite<br>recto<br>retto |

**RHOTON**  
 Mikrozängchen  
 Micro Forceps  
 Micro-Pince  
 Micro-Pinza  
 Mirco-Pinza

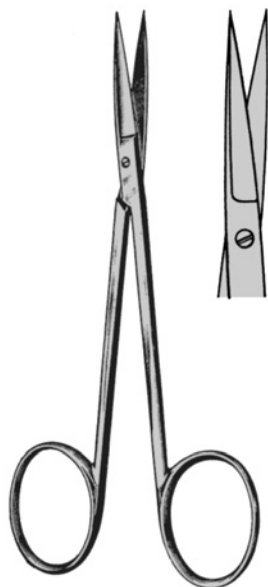

**IRIS**

- 13.0010 9,0 cm
- 13.0010SC** 9,0 cm
- 13.0012 10,5 cm
- 13.0012SC** 10,5 cm
- 13.0014 11,5 cm
- 13.0014SC** 11,5 cm



**IRIS**

- 13.0011 9,0 cm
- 13.0011SC** 9,0 cm
- 13.0013 10,5 cm
- 13.0013SC** 10,5 cm
- 13.0015 11,5 cm
- 13.0015SC** 11,5 cm



**IRIS**

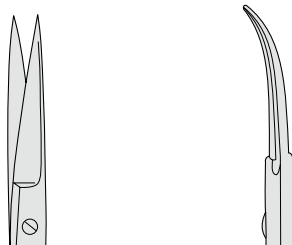

- 13.0012L 10,5 cm
- 13.0012LSC** 10,5 cm
- 13.0013L 10,5 cm
- 13.0013LSC** 10,5 cm

linkshändig / left handed /  
pour gaucher / para zurdo / per mancino

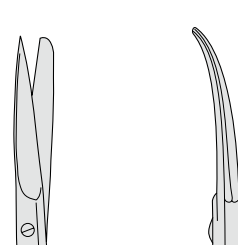

- 13.0022 10 cm
- 13.0023 10 cm

**TITANIUM**



**GRAEFE**  
 14.0010 10 cm



**GRAEFE**  
 14.0011 10 cm

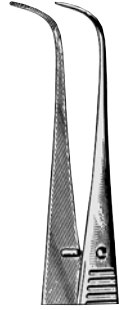

**GRAEFE**  
 14.0013 10 cm



**GRAEFE-SELECT**  
 10 cm



**30.2000**  
 0,8 mm



**30.2001**  
 0,8 mm



**30.2003**  
 0,8 mm



**30.2009**  
 0,8 mm



**30.2000 T**  
 0,8 mm



**30.2001T**  
 0,8 mm



**30.2003T**  
 0,8 mm



**GRAEFE-SELECT**  
 10 cm



**30.2004**  
 0,5 mm



**30.2005**  
 0,5 mm



**30.2007**  
 0,5 mm





**GRAEFE**  
 14.0510  
 10 cm 1x2



**14.0511**  
 10 cm 1x2

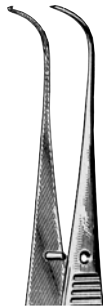

**14.0513**  
 10 cm 1x2



**GRAEFE-SELECT**  
 10 cm



**30.2010**  
 0,8 mm  
 1x2



**30.2011**  
 0,8 mm  
 1x2



**30.2013**  
 0,8 mm  
 1x2



**GRAEFE-SELECT**  
 10 cm



**30.2014**  
 0,5 mm  
 1x2



**30.2015**  
 0,5 mm  
 1x2



**30.2017**  
 0,5 mm  
 1x2



**MIKRO**  
 15.5 cm



**14.0780**  
 0,6 mm



**14.0782**  
 0,8 mm



**14.0784**  
 1,0 mm

Uhrmacher-Pinzetten / Jeweller Type Forceps / Pincès d'horloger  
 /Pinzas de relojero / Pinze di orologiaio

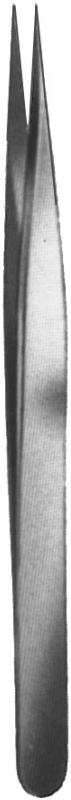

**JUWELIER #1**  
 14.1600 11,5 cm

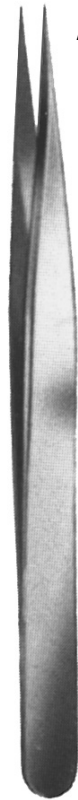

**JUWELIER #3**  
 14.1602 11,5 cm

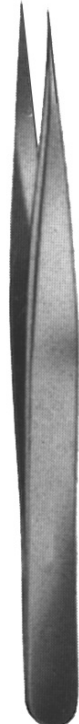

**JUWELIER #3C**  
 14.1603 10,5 cm

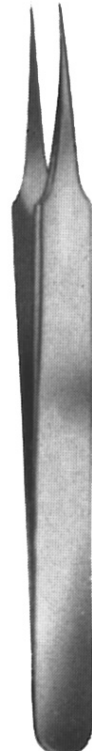

**JUWELIER #4**  
 14.1604 11 cm

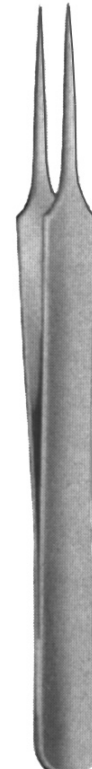

**JUWELIER #5**  
 14.1605 11 cm

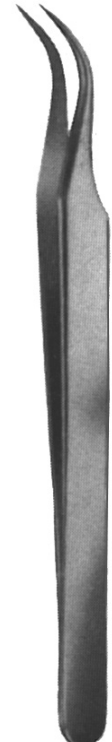

**JUWELIER #7**  
 14.1607 11,5 cm



**MIKRO**  
 15.5 cm



**14.0380**  
 0,6 mm



**14.0382**  
 0,8 mm



**14.0384**  
 1,0 mm



**PRO-MED Select**  
 14.1614 11 cm



**PRO-MED Select**  
 14.1617 11.5 cm



**ADSON**  
 14.0026 12 cm



**ADSON-MICRO**  
 14.0028 12 cm



**ADSON-MICRO**  
 14.0030 12 cm  
 14.0032 15 cm

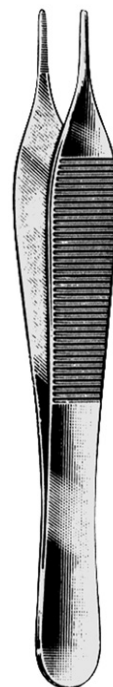
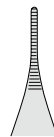

**ADSON**  
 14.0040 12 cm  
 14.0042 15 cm



12 cm

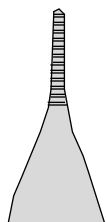

**EWALD**  
 14.0049

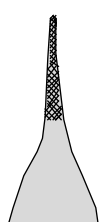

**ADSON**  
 "Criss-Cross"  
 14.0050



**ADSON-DEBAKEY**  
 14.0546 12,5 cm  
 14.0547 15,0 cm





**ADSON**  
 14.0526  
 12 cm 1x2



**ADSON-SELECT-MICRO**  
 14.0527  
 12 cm 1x2



**ADSON-MICRO**  
 14.0525 Ø 0,5 mm  
 14.0528 Ø 0,8 mm  
 12 cm 1x2



**ADSON-MICRO**  
 14.0530 12 cm  
 14.0532 15 cm

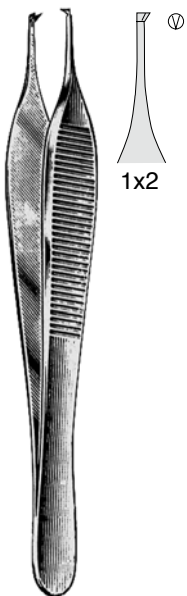

**ADSON**  
 14.0540 12 cm  
 14.0542 15 cm

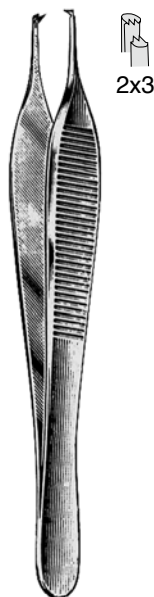

**ADSON**  
 14.0541 12 cm 2x3

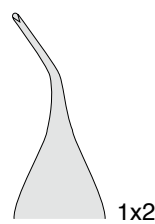

**ADSON**  
 14.0543 12 cm 45° 1x2  
 14.0545 15 cm 45° 1x2

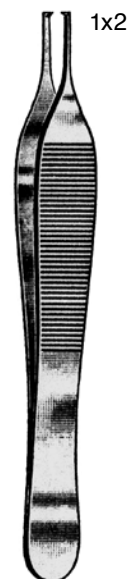

**EWALD**  
 14.0549 12 cm



**ADSON-GRAEFE**  
 14.0548 12 cm

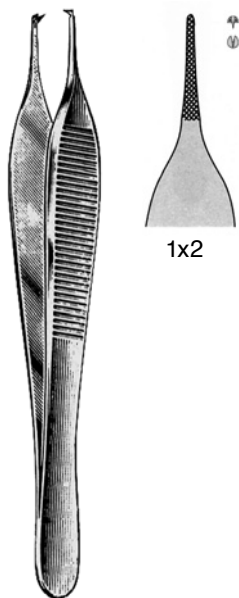

**ADSON**  
 "Criss-Cross"  
 14.0550 12 cm



**ADSON**  
 14.0554 18 cm

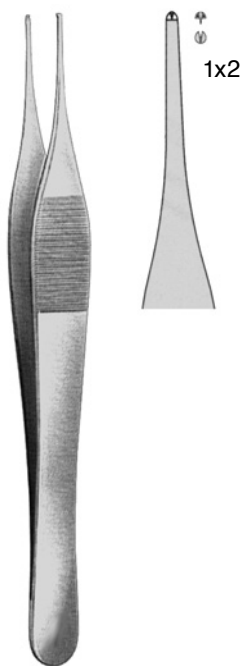

**JEFFERSON**  
 14.0556 18 cm



**SEMKEN**  
 14.0560 12 cm  
 14.0562 15 cm

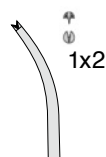

**SEMKEN**  
 14.0561 12 cm  
 14.0563 15 cm

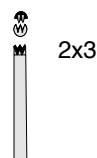

**SEMKEN**  
 14.0566 12 cm



**GILLIES**  
 14.0570 15 cm

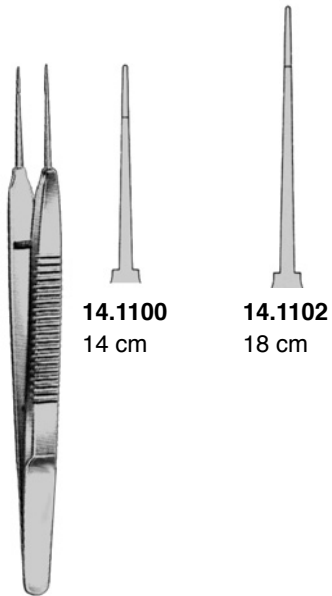

**14.1100**  
14 cm

**14.1102**  
18 cm

**AUSTIN**



**VISE**  
**14.1110**  
12 cm 0,3 mm



**VISE**  
**14.1112**  
13,5 cm 0,3 mm



**VISE**  
**14.1113**  
13,5 cm 0,3 mm

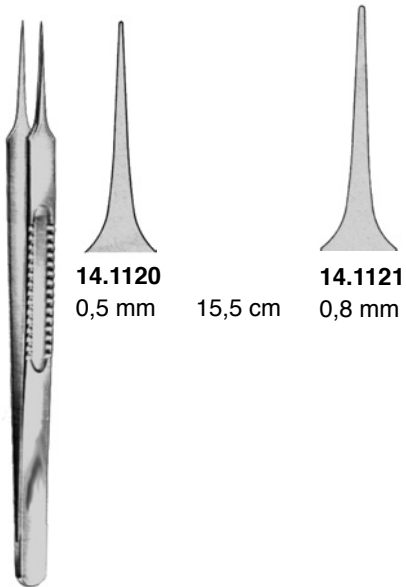

**14.1120**  
0,5 mm 15,5 cm

**14.1121**  
0,8 mm

**LAZAR**

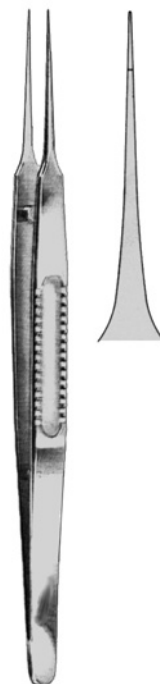

**LAZAR**  
**14.1122**  
18,5 cm 0,5 mm

Mikroskopiepinzetten  
 Microscopic Forceps  
 Pinzes à microscopie  
 Pinzas para microscopia  
 Pinze per microscopia



**14.1540**  
10 cm



**14.1542**  
10 cm

**PRO-MED** ist Ihnen behilflich bei der Zusammenstellung von Operationsbestecken für die verschiedensten Disziplinen. Fragen Sie nach unseren vorbereiteten OP-Bestecken.

For your convenience a wide variety of Suggested Operating Sets for most general and specialized procedures is available from **PRO-MED**. Please contact us or your local dealer.

**PRO-MED** vous propose de multiples compositions de boîtes opératoires multidisciplinaires. Demandez nos suggestions pour de nombreuses interventions.

**PRO-MED** le ayuda en componer varias cajas de instrumentos quirúrgicos. Pregunte por nuestro instrumental quirúrgico preparado.

Per la vostra comodità **PRO-MED** Vi aiuta nella raccolta di strumenti chirurgici per le varie discipline. Vi preghiamo di chiedere informazioni sui nostri set di strumenti chirurgici già preparati.



### JACOBSEN-MICRO

28.0011 11 cm

28.0015 15 cm

28.0018 18 cm

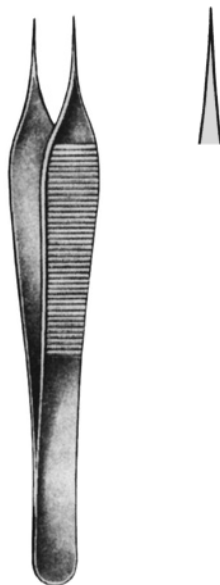

### JACOBSEN-ADSON

28.0030 12 cm

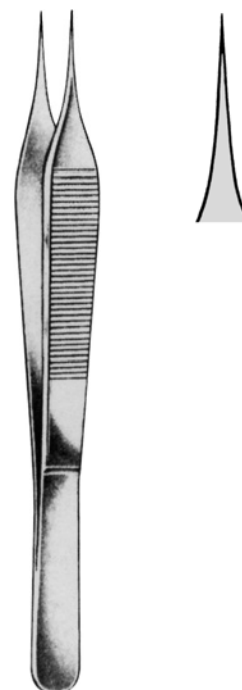

### JACOBSEN-ADSON

28.0032 15 cm



12 cm / 8 mm

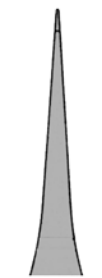

28.0080

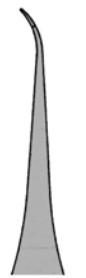

28.0081



15 cm / 8 mm

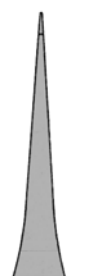

28.0082

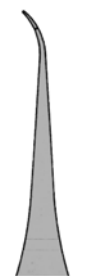

28.0083



Mikro-Knüpfpinzetten  
Micro Suture Forceps  
Micro Pincès à sutures  
Micro pinzas para suturas  
Micro-pinze per ligature



18 cm / 8 mm

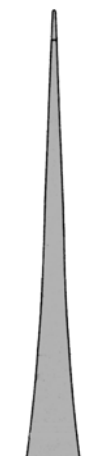

28.0084



28.0085



21 cm / 8 mm

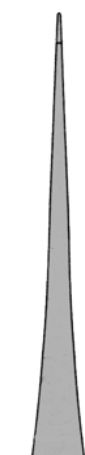

28.0086



28.0087

Tumor- und Gewebefäßpinzetten  
Tumor- and Tissue Grasping Forceps  
Pinces pour saisir tumeurs et tissus  
Pinzas para coger tejidos y tumores  
Pinze per afferare tessuti e tumori

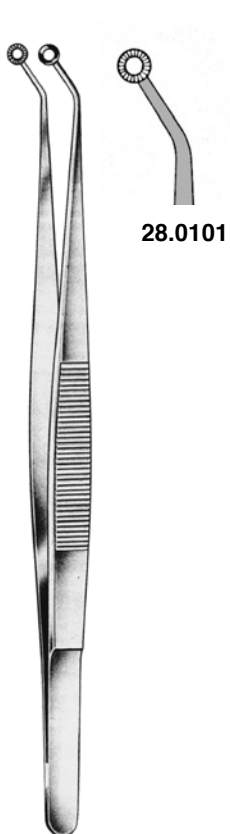

**HUNT**  
20 cm

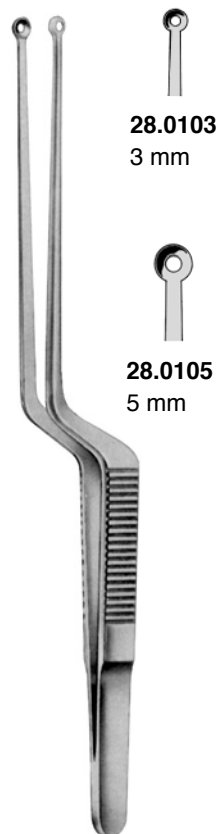

**YASARGIL**  
22 cm

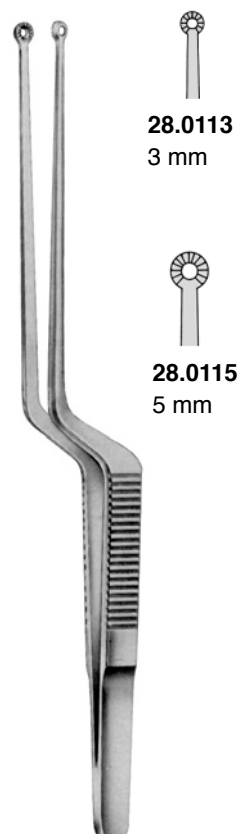

**YASARGIL**  
22 cm

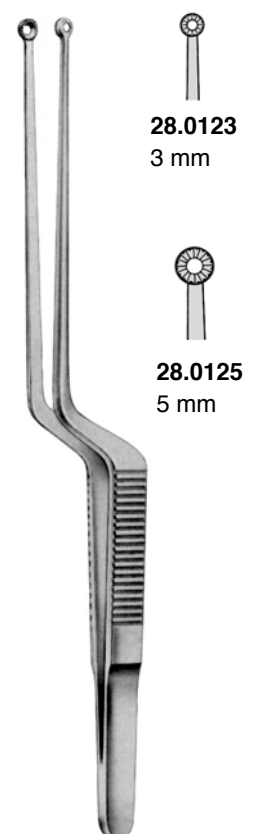

**HEIFETZ**  
22 cm



Diamantbeschichtete Spitzen  
Diamond coated tips  
Avec pointes diamantées  
Puntas con cascos de diamante  
con punte diamantate

**TITANIUM**



spitz  
sharp  
pointu  
agudo  
appuntato



stumpf  
blunt  
mousse  
romo  
smusso

**28.0130** 18.5 cm  
**28.0136** 22.5 cm

**28.0132** 18.5 cm  
**28.0138** 22.5 cm

Mikro-Nahtpinzetten mit Gegengewicht und diamantbeschichteten Spitzen  
Micro-Suturing Forceps counterbalanced with diamond coated tips  
Micro pincès à suture avec contrepoids, pointes diamantées  
Micro pinzas para sutura con contrapeso, puntas con cascos de diamante  
Micro-pinze per sutura con contrapeso, punte diamantate

## RHOTON-"BALANCE"



6 x 0,4mm

18 cm  
21 cm



**28.0362SD**  
**28.0364SD**



**28.0363SD**  
**28.0365SD**

6 x 0,8mm

18 cm  
21 cm



**28.0372SD**  
**28.0374SD**



**28.0373SD**  
**28.0375SD**



6 x 0,4mm

18 cm  
21 cm

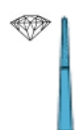

**28.0362T**  
**28.0364T**

**TITANIUM**



**28.0363T**  
**28.0365T**

**TITANIUM**

6 x 0,8 mm

18 cm  
21 cm



**28.0372T**  
**28.0374T**

**TITANIUM**



**28.0373T**  
**28.0375T**

**TITANIUM**

**TITANIUM**



Diamantbeschichtete Spitzen  
 Diamond coated tips  
 Avec pointes diamantées  
 Puntas con cascos de diamante  
 Con punte diamantate

**RHOTON**



0,4mm

15 cm  
 18 cm  
 21 cm  
 23 cm

**28.0220SD**  
**28.0222SD**  
**28.0224SD**  
**28.0226SD**



**28.0221SD**  
**28.0223SD**  
**28.0225SD**  
**28.0227SD**

0,8mm

15 cm  
 18 cm  
 21 cm  
 23 cm

**28.0230SD**  
**28.0232SD**  
**28.0234SD**  
**28.0236SD**



**28.0231SD**  
**28.0233SD**  
**28.0235SD**  
**28.0237SD**



0,4mm

15 cm  
 18 cm  
 21 cm  
 23 cm

**28.0220T**  
**28.0222T**  
**28.0224T**  
**28.0226T**



**28.0221T**  
**28.0223T**  
**28.0225T**  
**28.0227T**

**TITANIUM**

**TITANIUM**

0,8mm

15 cm  
 18 cm  
 21 cm  
 23 cm

**28.0230T**  
**28.0232T**  
**28.0234T**  
**28.0236T**



**28.0231T**  
**28.0233T**  
**28.0235T**  
**28.0237T**

**TITANIUM**

**TITANIUM**

**RHOTON-"BALANCE"**

Mikropinzetten mit Gegengewicht und diamantbeschichteten Spitzen  
 Micro-Forceps counterbalanced with diamond coated tips  
 Micro pinces avec contrepoides, pointes diamantées  
 Micro pinzas para con contrapeso, puntas con cascos de diamante  
 Micro-pinze con contrappeso, punte diamantate



0,4mm

18 cm  
 21 cm

**28.0382SD**  
**28.0384SD**



**28.0383SD**  
**28.0385SD**

0,8mm

18 cm  
 21 cm

**28.0392SD**  
**28.0394SD**



**28.0393SD**  
**28.0395SD**



0,4mm

18 cm  
 21 cm

**28.0382T**  
**28.0384T**



**28.0383T**  
**28.0385T**

**TITANIUM**

**TITANIUM**

0,8mm

18 cm  
 21 cm

**28.0392T**  
**28.0394T**



**28.0393T**  
**28.0395T**

**TITANIUM**

**TITANIUM**









## TITANIUM











Diamantbeschichtete Spitzen  
Diamond coated tips  
Avec pointes diamantées  
Puntas con cascós de diamante  
Con punte diamantate

### RHOTON



					
					
6 x 0,4mm			6 x 0,8 mm		
15 cm	<b>28.0260SD</b>	<b>28.0261SD</b>	15 cm	<b>28.0270SD</b>	<b>28.0271SD</b>
18 cm	<b>28.0262SD</b>	<b>28.0263SD</b>	18 cm	<b>28.0272SD</b>	<b>28.0273SD</b>
21 cm	<b>28.0264SD</b>	<b>28.0265SD</b>	21 cm	<b>28.0274SD</b>	<b>28.0275SD</b>
23 cm	<b>28.0266SD</b>	<b>28.0267SD</b>	23 cm	<b>28.0276SD</b>	<b>28.0277SD</b>



					
					
6 x 0,4mm			6 x 0,8 mm		
15 cm	<b>28.0260T</b>	<b>28.0261T</b>	15 cm	<b>28.0270T</b>	<b>28.0271T</b>
18 cm	<b>28.0262T</b>	<b>28.0263T</b>	18 cm	<b>28.0272T</b>	<b>28.0273T</b>
21 cm	<b>28.0264T</b>	<b>28.0265T</b>	21 cm	<b>28.0274T</b>	<b>28.0275T</b>
23 cm	<b>28.0266T</b>	<b>28.0267T</b>	23 cm	<b>28.0276T</b>	<b>28.0277T</b>
	<b>TITANIUM</b>	<b>TITANIUM</b>		<b>TITANIUM</b>	<b>TITANIUM</b>









**TITANIUM**











Diamantbeschichtete Spitzen  
 Diamond coated tips  
 Avec pointes diamantées  
 Puntas con cascos de diamante  
 Con punte diamantate

**RHOTON**



					
					
6 x 0,4mm			6 x 0,8 mm		
15 cm	<b>28.0280SD</b>	<b>28.0281SD</b>	15 cm	<b>28.0290SD</b>	<b>28.0291SD</b>
18 cm	<b>28.0282SD</b>	<b>28.0283SD</b>	18 cm	<b>28.0292SD</b>	<b>28.0293SD</b>
21 cm	<b>28.0284SD</b>	<b>28.0285SD</b>	21 cm	<b>28.0294SD</b>	<b>28.0295SD</b>
23 cm	<b>28.0286SD</b>	<b>28.0287SD</b>	23 cm	<b>28.0296SD</b>	<b>28.0297SD</b>



					
					
6 x 0,4mm			6 x 0,8 mm		
15 cm	<b>28.0280T</b>	<b>28.0281T</b>	15 cm	<b>28.0290T</b>	<b>28.0291T</b>
18 cm	<b>28.0282T</b>	<b>28.0283T</b>	18 cm	<b>28.0292T</b>	<b>28.0293T</b>
21 cm	<b>28.0284T</b>	<b>28.0285T</b>	21 cm	<b>28.0294T</b>	<b>28.0295T</b>
23 cm	<b>28.0286T</b>	<b>28.0287T</b>	23 cm	<b>28.0296T</b>	<b>28.0297T</b>
	<b>TITANIUM</b>	<b>TITANIUM</b>		<b>TITANIUM</b>	<b>TITANIUM</b>

## TITANIUM



Diamantbeschichtete Spitzen  
Diamond coated tips  
Avec pointes diamantées  
Puntas con cascos de diamante  
Con punte diamantate



## RHOTON

1 x 0,5mm

15 cm  
18 cm  
21 cm  
23 cm

**28.0240T**  
**28.0242T**  
**28.0244T**  
**28.0246T**



**28.0240SD**  
**28.0242SD**  
**28.0244SD**  
**28.0246SD**

**TITANIUM**

2 x 1,0 mm

15 cm  
18 cm  
21 cm  
23 cm

**28.0250T**  
**28.0252T**  
**28.0254T**  
**28.0256T**



**28.0250SD**  
**28.0252SD**  
**28.0254SD**  
**28.0256SD**

**TITANIUM**

Mikro-Ringpinzetten mit Gegengewicht und diamantbeschichteten Spitzen  
Micro Ring Forceps counterbalanced with diamond coated tips  
Micro pinces à anneau avec contrepoides, pointes diamantées  
Micro pinzas con ojal y contrapeso, puntas con cascos de diamante  
Micro-pinze con anello e contrappeso, punte diamantate

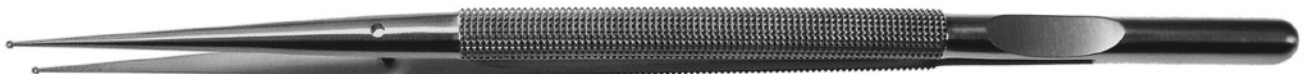

## RHOTON

1 x 0,5mm

18 cm  
21 cm

**28.0342T**  
**28.0344T**



**28.0342SD**  
**28.0344SD**

**TITANIUM**

2 x 1,0 mm

18 cm  
21 cm

**28.0352T**  
**28.0354T**





**28.0352SD**  
**28.0354SD**

**TITANIUM**



**TITANIUM**



**DEBAKEY**

		
1,2 mm		
15 cm	<b>28.0320T</b>	28.0320S
18 cm	<b>28.0322T</b>	28.0322S
21 cm	<b>28.0324T</b>	28.0324S
23 cm	<b>28.0326T</b>	28.0326S

**TITANIUM**

		
1,8 mm		
15 cm	<b>28.0330T</b>	28.0330S
18 cm	<b>28.0332T</b>	28.0332S
21 cm	<b>28.0334T</b>	28.0334S
23 cm	<b>28.0336T</b>	28.0336S

**TITANIUM**





**28.0600** 16 cm  
**28.0602** 18 cm  
**28.0604** 20 cm  
**28.0606** 22 cm  
**28.0608** 24 cm

Spitzen 0,6 mm  
 Tips 0,6 mm  
 bout 0,6 mm  
 punta 0,6 mm  
 punte 0,6 mm



**28.0610** 16 cm  
**28.0612** 18 cm  
**28.0614** 20 cm  
**28.0616** 22 cm  
**28.0618** 24 cm

Spitzen 0,9 mm  
 Tips 0,9 mm  
 bout 0,9 mm  
 punta 0,9 mm  
 punte 0,9 mm



**28.0622** 18 cm

1 x 2 Zähne  
 1 x 2 teeth  
 1 x 2 dents  
 1 x 2 dientes  
 1 x 2 denti



Ø 3 mm



**YASARGIL**  
**YASARGIL-SAMII**  
28.0710 22 cm  
28.0700 24 cm

Ø 5 mm



**YASARGIL**  
**YASARGIL-SAMII**  
28.0712 22 cm  
28.0702 24 cm

Ø 7 mm



**YASARGIL-SAMII**  
28.0704 24 cm

löffelförmig  
spoon-shaped  
en forme de cuillère  
forma cuchara  
forma di cucchiaio

Ø 3 mm



**YASARGIL**  
28.0714 22 cm  
gezahnt/serrated/  
dentelés/dentada/dentate

Ø 3 mm



**HEIFETZ**  
28.0715 22 cm  
gezahnt/serrated/  
dentelés/dentada/dentate

Ø 5 mm



**HEIFETZ**  
28.0717 22 cm  
kürettenförmig gezahnt  
curette-shaped serrated  
en forme de curette dentelés  
forma cureta dentada  
forma di cucchiaio dentate

Ø 5 mm



**YASARGIL**  
28.0716 22 cm  
flach, gezahnt  
flat, serrated  
mors plats, dentelés  
boca plana, dentada  
morsi piatti, dentate

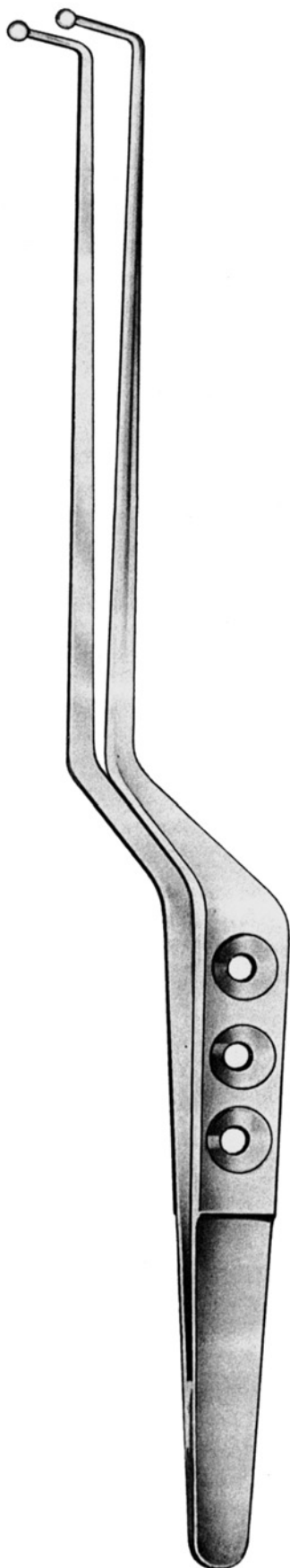

**SAMII**  
23 cm

löffelförmig  
spoon-shaped  
en forme de cuillère  
forma cuchara  
forma di cucchiaio

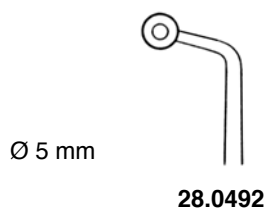
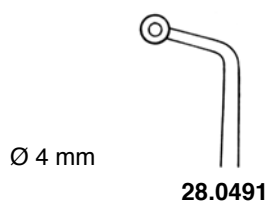
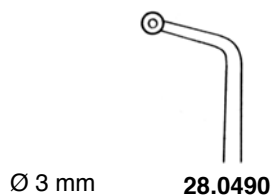



**CASTROVIEJO**



**18.0800** 14 cm  
**18.0802** 18 cm  
**18.0804** 22 cm

18.1800 14 cm  
 18.1802 18 cm  
 18.1804 22 cm



**18.0810**  
**18.0812**  
**18.0814**

18.1810  
 18.1812  
 18.1814



**18.0801** 14 cm  
**18.0803** 18 cm  
**18.0805** 22 cm

18.1801 14 cm  
 18.1803 18 cm  
 18.1805 22 cm



**18.0811**  
**18.0813**  
**18.0815**

18.1811  
 18.1813  
 18.1815



**CASTROVIEJO**

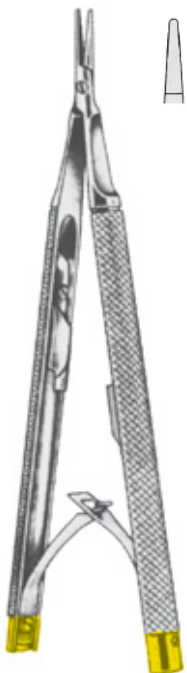

**CASTROVIEJO**  
 18.0840 13 cm

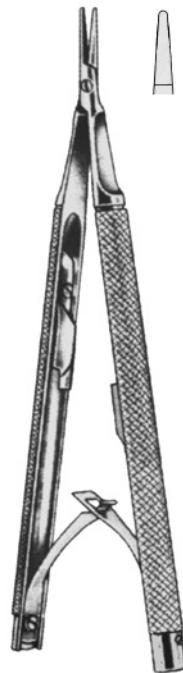

**CASTROVIEJO**  
 18.1840 13 cm



**BOYNTON**  
 18.1850 12 cm



  
**28.3100**  
15 cm

  
**28.3101**  
15 cm

REILL



  
**28.3102**  
15 cm

  
**28.3103**  
15 cm

REILL



**28.3130**  
12,5 cm / Ø 7 mm  
gerade  
straight  
droit  
recto  
retto

**28.3131**  
12,5 cm / Ø 7 mm  
gebogen  
curved  
courbe  
curvo  
curvo

ohne Sperre  
without lock  
sens arrêt  
sin cierre  
senza cremagliera



**28.3132**  
12,5 cm / Ø 7 mm  
gerade  
straight  
droit  
recto  
retto

**28.3133**  
12,5 cm / Ø 7 mm  
gebogen  
curved  
courbe  
curvo  
curvo

mit Sperre  
with lock  
avec arrêt  
con cierre  
con cremagliera



**28.3140**  
15 cm / Ø 8 mm

**28.3150**  
18 cm / Ø 8mm

gerade  
straight  
droit  
recto  
retto



**28.3141**  
15 cm / Ø 8 mm

**28.3151**  
18 cm / Ø 8 mm

gebogen  
curved  
courbe  
curvo  
curvo



**28.3142**  
15 cm / Ø 8 mm

**28.3152**  
18 cm / Ø 8 mm

gerade mit Sperre  
straight with lock  
droit avec arrêt  
recto con cierre  
retto con cremagliera



**28.3143**  
15 cm / Ø 8 mm

**28.3153**  
18 cm / Ø 8 mm

gebogen mit Sperre  
curved with lock  
courbe avec arrêt  
curvo con cierre  
curvo con cremagliera





21 cm

mit Sperre  
with lock  
avec arrêt  
con cierre  
con cremagliera

**28.3154**  
gerade  
straight  
droit  
recto  
retto

**28.3155**  
gebogen  
curved  
courbe  
curvo  
curvo



23 cm

mit Sperre  
with lock  
avec arrêt  
con cierre  
con cremagliera

**28.3156**  
gerade  
straight  
droit  
recto  
retto

**28.3157**  
gebogen  
curved  
courbe  
curvo  
curvo



15 cm

**28.3242**  
gerade  
straight  
droit  
recto  
retto

**28.3243**  
gebogen  
curved  
courbe  
curvo  
curvo



18 cm

**28.3252**  
gerade  
straight  
droit  
recto  
retto

**28.3253**  
gebogen  
curved  
courbe  
curvo  
curvo



21 cm

**28.3254**

gerade  
straight  
droit  
recto  
retto

**28.3255**

gebogen  
curved  
courbe  
curvo  
curvo



23 cm

**28.3256**

gerade  
straight  
droit  
recto  
retto

**28.3257**

gebogen  
curved  
courbe  
curvo  
curvo



JACOBSON



**28.3400**  
18,5 cm  
**28.3402**  
21 cm  
**28.3404**  
23 cm



JACOBSON



**28.3406**  
18,5 cm  
**28.3408**  
21 cm

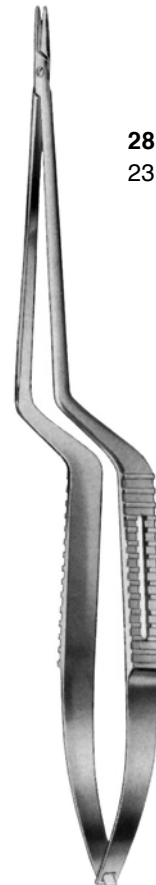

MIKRO-NADELHALTER



**28.3450**  
23 cm



**28.3451**  
23 cm



Diamantbeschichtete Spitzen  
Diamond coated tips  
Avec pointes diamantées  
Puntas con cascós de diamante  
Morsi con rivestimento di diamante



Maul 2 mm breit gerieft  
Jaws 2 mm wide serrated  
mors 2 mm, dentelées  
boca 2 mm, dentadas  
morso 2 mm, dentato

**28.3662**

18 cm / 10 mm

**28.3664**

21 cm / 10 mm

**GREGORY**



**28.3662D**

18 cm / 10 mm

**28.3664D**

21 cm / 10 mm









**GREGORY**









**TITANIUM**



















Diamantbeschichtete Spitzen  
 Diamond coated tips  
 Avec pointes diamantées  
 Puntas con cascós de diamante  
 Morsi con rivestimento di diamante

ohne Sperre  
 without lock  
 sens arrêt  
 sin cierre  
 senza cremagliera

				
0,4mm				
15 cm		<b>28.3600</b>	28.3600SD	28.3600S
18 cm		<b>28.3602</b>	28.3602SD	28.3602S
21 cm		<b>28.3604</b>	28.3604SD	28.3604S
23 cm		<b>28.3606</b>	28.3606SD	28.3606S

				
0,4mm				
15 cm		<b>28.3601</b>	28.3601SD	28.3601S
18 cm		<b>28.3603</b>	28.3603SD	28.3603S
21 cm		<b>28.3605</b>	28.3605SD	28.3605S
23 cm		<b>28.3607</b>	28.3607SD	28.3607S

				
0,8mm				
15 cm		<b>28.3610</b>	28.3610SD	28.3610S
18 cm		<b>28.3612</b>	28.3612SD	28.3612S
21 cm		<b>28.3614</b>	28.3614SD	28.3614S
23 cm		<b>28.3616</b>	28.3616SD	28.3616S

				
0,8mm				
15 cm		<b>28.3611</b>	28.3611SD	28.3611S
18 cm		<b>28.3613</b>	28.3613SD	28.3613S
21 cm		<b>28.3615</b>	28.3615SD	28.3615S
23 cm		<b>28.3617</b>	28.3617SD	28.3617S

**TITANIUM**





**TITANIUM**





## TITANIUM











Diamantbeschichtete Spitzen  
 Diamond coated tips  
 Avec pointes diamantées  
 Puntas con cascos de diamante  
 Morsi con rivestimento di diamante

mit Sperre  
 with lock  
 avec arrêt  
 con cierre  
 con cremagliera

				
0,4mm				
15 cm		<b>28.3630</b>	28.3630SD	28.3630S
18 cm		<b>28.3632</b>	28.3632SD	28.3632S
21 cm		<b>28.3634</b>	28.3634SD	28.3634S
23 cm		<b>28.3636</b>	28.3636SD	28.3636S

				
0,4mm				
15 cm		<b>28.3631</b>	28.3631SD	28.3631S
18 cm		<b>28.3633</b>	28.3633SD	28.3633S
21 cm		<b>28.3635</b>	28.3635SD	28.3635S
23 cm		<b>28.3637</b>	28.3637SD	28.3637S

				
0,8mm				
15 cm		<b>28.3640</b>	28.3640SD	28.3640S
18 cm		<b>28.3642</b>	28.3642SD	28.3642S
21 cm		<b>28.3644</b>	28.3644SD	28.3644S
23 cm		<b>28.3646</b>	28.3646SD	28.3646S

				
0,8mm				
15 cm		<b>28.3641</b>	28.3641SD	28.3640S
18 cm		<b>28.3643</b>	28.3643SD	28.3642S
21 cm		<b>28.3645</b>	28.3645SD	28.3644S
23 cm		<b>28.3647</b>	28.3647SD	28.3647S

TITANIUM

TITANIUM

**TITANIUM**



Diamantbeschichtete Spitzen  
 Diamond coated tips  
 Avec pointes diamantées  
 Puntas con cascos de diamante  
 Morsi con rivestimento di diamante

ohne Sperre  
 without lock  
 sens arrêt  
 sin cierre  
 senza cremagliera



1 mm  
 21 cm



**28.3700**



28.3700SD



28.3700S

1 mm  
 21 cm



**28.3701**



28.3701SD



28.3701S

1 mm  
 23 cm



**28.3702**

**TITANIUM**



28.3702SD



28.3702S

1 mm  
 23 cm



**28.3703**

**TITANIUM**



28.3703SD



28.3703S





**28.3504** 20,0 cm  
**28.3506** 22,0 cm



**28.3501** 16,0 cm  
**28.3505** 20,0 cm  
**28.3507** 22,0 cm  
**28.3509** 24,0 cm

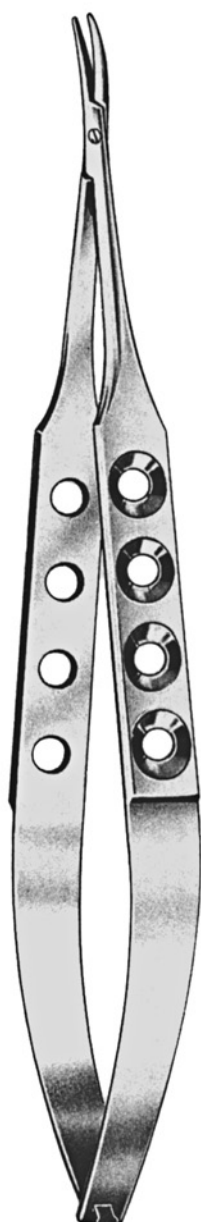

**28.3520** 16,0 cm  
**28.3522** 18,0 cm



**28.3521** 16,0 cm  
**28.3523** 18,0 cm

**PRO-MED** ist Ihnen behilflich bei der Zusammenstellung von Operationsbestecken für die verschiedensten Disziplinen. Fragen Sie nach unseren vorbereiteten OP-Bestecken.

For your convenience a wide variety of Suggested Operating Sets for most general and specialized procedures is available from **PRO-MED**. Please contact us or your local dealer.

**PRO-MED** vous propose de multiples compositions de boîtes opératoires multidisciplinaires. Demandez nos suggestions pour de nombreuses interventions.

**PRO-MED** le ayuda en componer varias cajas de instrumentos quirúrgicos. Pregunte por nuestro instrumental quirúrgico preparado.

Per la vostra comodità **PRO-MED** Vi aiuta nella raccolta di strumenti chirurgici per le varie discipline. Vi preghiamo di chiedere informazioni sui nostri set di strumenti chirurgici già preparati.



**DERF**  
 18.0010 12 cm

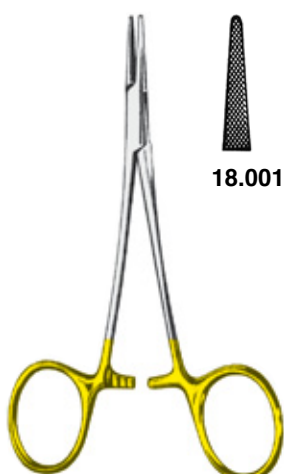

**HALSEY-MICRO**  
 12 cm



18.0016



18.0018  
 glatt  
 smooth  
 lisse  
 lisa  
 liscio

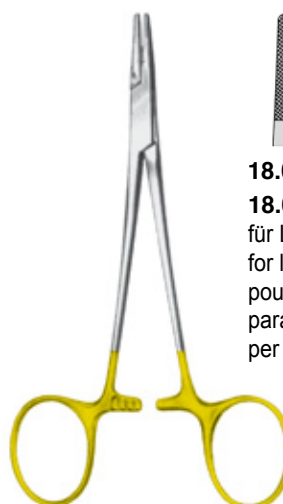

**HALSEY**  
 13 cm



18.0020  
**18.0020 L**  
 für Linkshänder  
 for left-handers  
 pour gauchers  
 para zurdos  
 per mancino



18.0025  
 glatt  
 smooth  
 lisse  
 lisa  
 liscio



**WEBSTER**  
 13 cm



18.0026  
 glatt  
 smooth  
 lisse  
 lisa  
 liscio



18.0029



**BAUMGARTNER**  
 18.0030 14 cm



**KILNER**  
 13 cm



18.0040



18.0042  
 glatt  
 smooth  
 lisse  
 lisa  
 liscio



**NEIVERT**  
18.0050 12 cm



**BABY-CRILE-WOOD**  
18.0069 15 cm



**CRILE-WOOD**

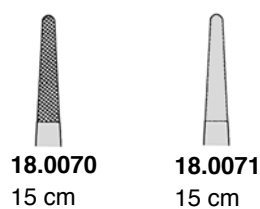

**18.0070**  
15 cm

**18.0071**  
15 cm

**18.0070L**

15 cm  
für Linkshänder  
for left-handers  
pour gauchers  
para zurdos  
per mancino



**18.0072**  
18 cm

**18.0074**  
20 cm

**18.0076**  
23 cm

**18.0072L**  
18 cm

**18.0074L**  
20 cm

**18.0076L**  
23 cm

für Linkshänder / for left-handers / pour gauchers  
para zurdos / per mancino

## TITANIUM

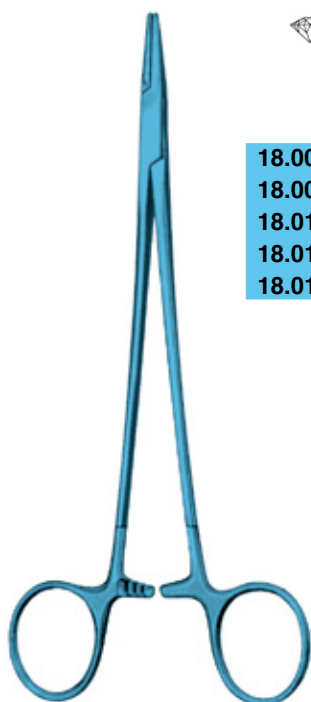

**MICRO-VASCULAR**

- 18.0016TD** 12,5 cm
- 18.0070TD** 14,5 cm
- 18.0100TD** 17,5 cm
- 18.0102TD** 19,5 cm
- 18.0104TD** 22,5 cm



Diamantbeschichtete Spitzen  
 Diamond coated tips  
 Avec pointes diamantées  
 Puntas con cascós de diamante  
 Morsi con rivestimento di diamante



Diamantbeschichtete Spitzen  
 Diamond coated tips  
 Avec pointes diamantées  
 Puntas con cascos de diamante  
 Morsi con rivestimento di diamante



**DEBAKEY-SELECT**



**18.0100D**  
18 cm



**18.0102D**  
20 cm



**18.0104D**  
23 cm



**18.0106D**  
25 cm



**JULIAN**

**18.0113** 20 cm  
**18.0115** 23 cm



**NEW ORLEANS**

**18.0120**  
18 cm

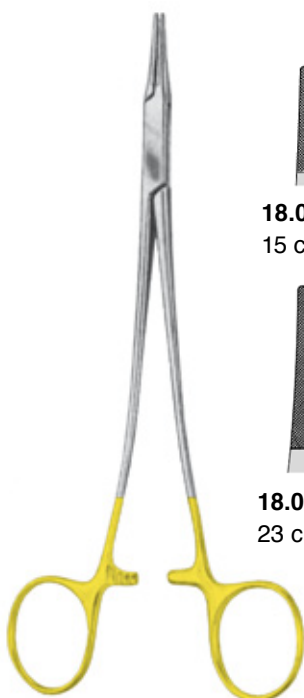

**MICRO-VASCULAR**



**18.0130**  
15 cm



**18.0132**  
18 cm



**18.0134**  
20 cm



**18.0136**  
23 cm



**18.0138**  
25 cm



**MICRO-VASCULAR-SELECT**



**18.0130D**  
15 cm



**18.0132D**  
18 cm



**18.0134D**  
20 cm



**18.0136D**  
23 cm



**18.0138D**  
25 cm

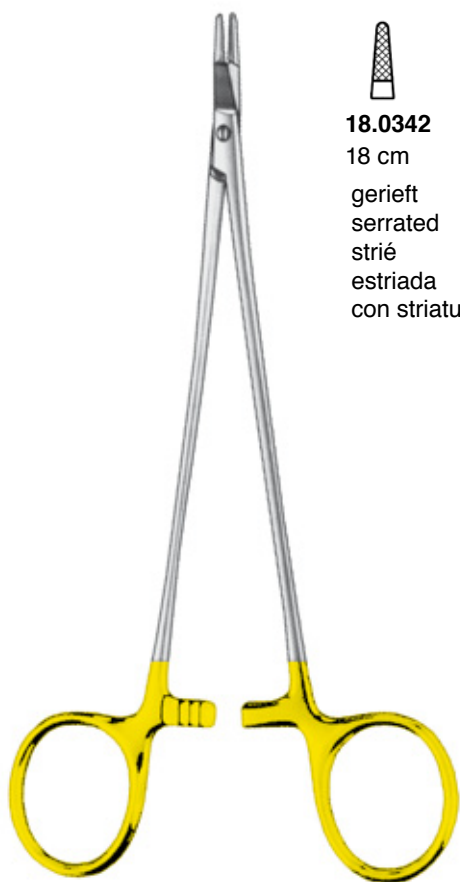

**KAYE**



**18.0342**  
 18 cm  
 gerieft  
 serrated  
 strié  
 estriada  
 con striatura



**18.0343**  
 18 cm  
 glatt  
 smooth  
 lisse  
 lisa  
 liscio

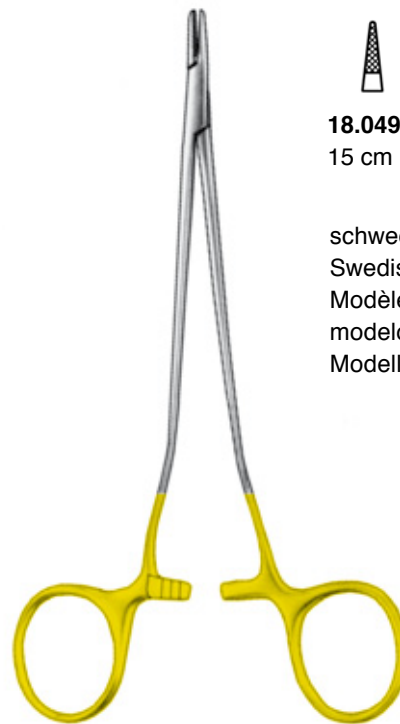

**PRO-MED**



**18.0490**  
 15 cm

schwedisches Modell  
 Swedish model  
 Modèle suédoise  
 modelo sueco  
 Modello svedese

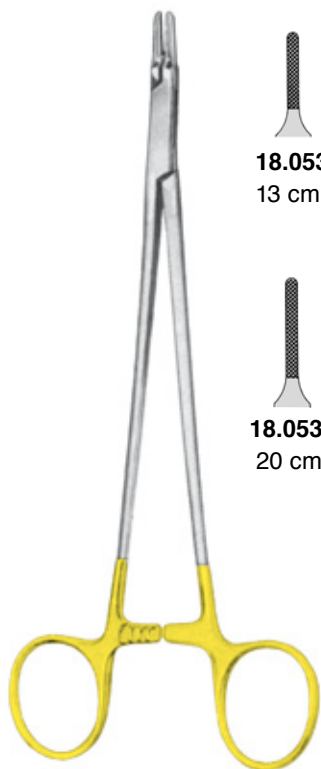

**RYDER**



**18.0530**  
 13 cm



**18.0532**  
 15 cm



**18.0534**  
 18 cm

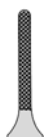

**18.0536**  
 20 cm



**18.0538**  
 23 cm



**18.0540**  
 26 cm

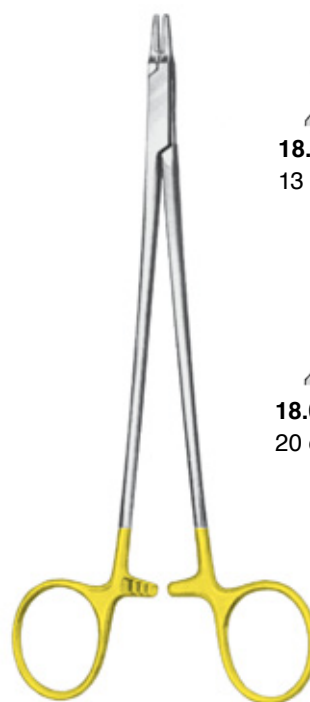

**RYDER-MINI**

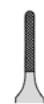

**18.0550**  
 13 cm



**18.0552**  
 15 cm



**18.0554**  
 18 cm



**18.0556**  
 20 cm



**18.0558**  
 23 cm



**18.0560**  
 25 cm



Diamantbeschichtete Spitzen  
Diamond coated tips  
Avec pointes diamantées  
Puntas con cascós de diamante  
Morsi con rivestimento di diamante



### RYDER-MINI-SELECT

**18.0550D** 12,5 cm  
**18.0552D** 15,0 cm  
**18.0554D** 18,0 cm  
**18.0556D** 20,0 cm  
**18.0558D** 23,0 cm



### DIETRICH

**18.0600** 18 cm  
**18.0602** 20 cm  
**18.0604** 23 cm  
**18.0606** 26 cm



**30.0430**  
 14 cm  
 scharf  
 sharp  
 pointu  
 agudo  
 acuto



**30.0432**  
 14 cm  
 scharf  
 sharp  
 pointu  
 agudo  
 acuto



**30.0431**  
 14 cm  
 stumpf  
 blunt  
 mousse  
 romo  
 smusso



**30.0433**  
 14 cm  
 stumpf  
 blunt  
 mousse  
 romo  
 smusso

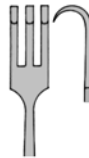

**AXENFELD**



**30.0502**  
 16 cm  
 scharf  
 sharp  
 pointu  
 agudo  
 acuto



**30.0503**  
 16 cm  
 stumpf  
 blunt  
 mousse  
 romo  
 smusso

**GRAEFE**



**BONN**  
**30.0510**  
 14 cm



**TÜBINGEN**  
 13,5 cm

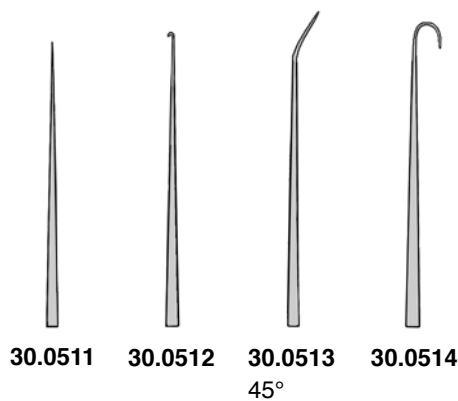

**30.0511**

**30.0512**

**30.0513**  
 45°

**30.0514**



**DOPPELKRALLE**  
 11 cm



**30.0570**  
 rechts  
 right  
 à droite  
 derecha  
 destra



**30.0571**  
 links  
 left  
 à gauche  
 izquierda  
 sinistra



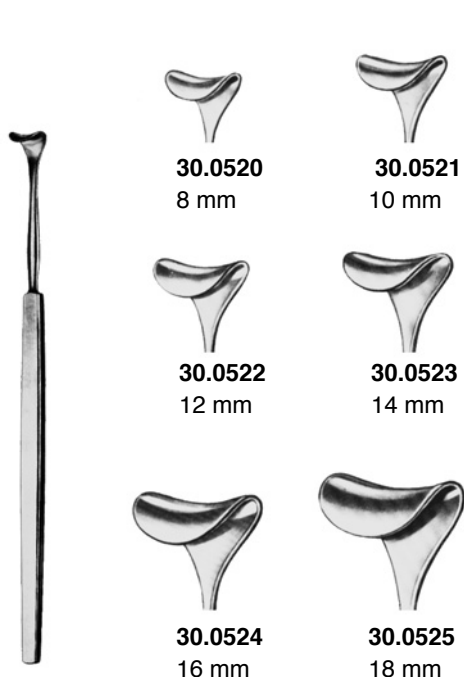

**DESMARRES**  
13 cm

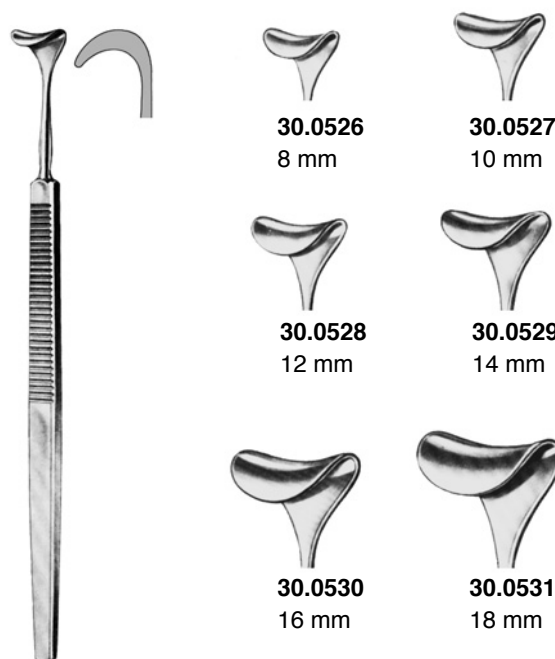

**DESMARRES**  
16 cm

Schielhaken, Muskelhaken  
 Strabismus- and Muscle hooks  
 Crochets à strabisme, Crochets musculaires  
 Ganchos para estrabismo y musculares  
 Uncinetti per strabismo e per muscoli



**GRAEFE**  
30.0550  
13 cm

**GRAEFE**  
30.0551  
13 cm

**GRAEFE**  
30.0552  
13 cm

**STEVENS**  
30.0555  
12 cm

**JAMESON**  
30.0560  
13 cm

**GREEN**  
30.0562  
13 cm

**JAEGER**  
30.0581  
13 cm #1

**JAEGER**  
30.0582  
13 cm #2

Ohrhäkchen  
Ear hooklets  
Crochets auriculaires  
Ganchitos auriculares  
Uncini auricolari

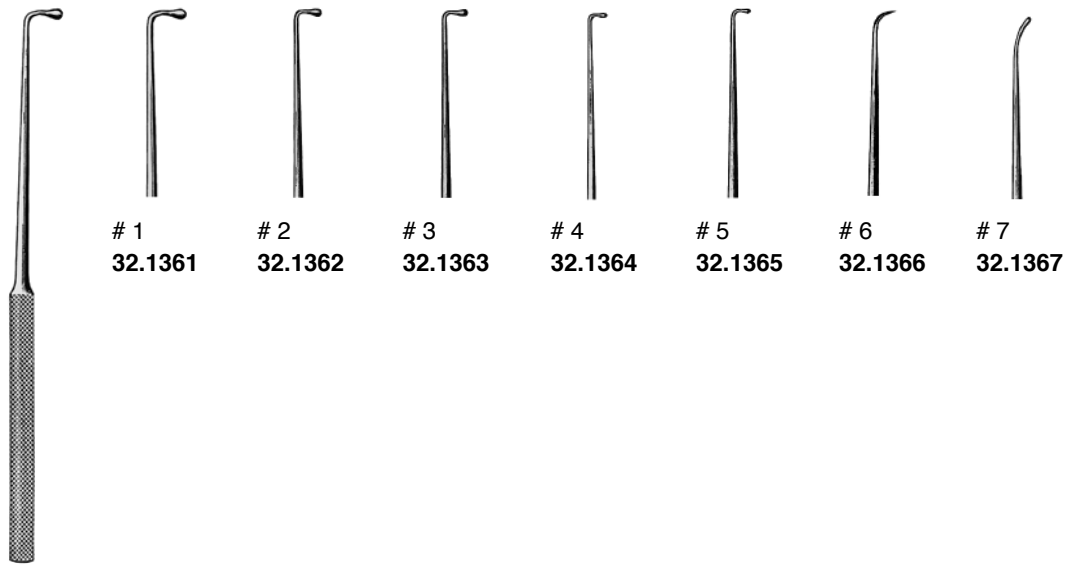

**WAGENER**  
14 cm



**ALLPORT**  
32.1368  
16 cm

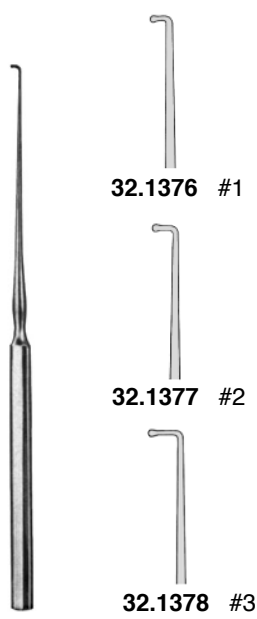

**LUCAE**  
14 cm

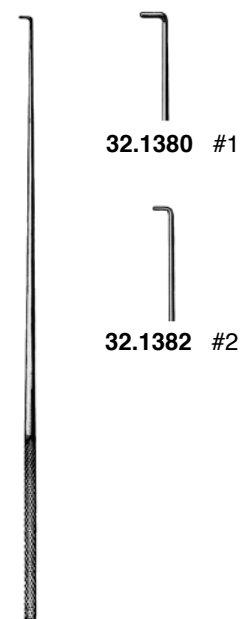

**DAY**  
16 cm



**SACHS**  
27.1222  
18 cm



**SMITHWICK**  
27.1226  
17 cm



**SMITHWICK**  
27.1228  
21 cm



**DANDY**  
27.1230  
20 cm

gerade  
straight  
droit  
recto  
retto



**DANDY**  
27.1231  
20 cm

links  
left  
à gauche  
izquierdo  
sinistra



**DANDY**  
27.1232  
20 cm

rechts  
right  
à droite  
derecho  
destra



**CUSHING**  
27.1240 19 cm / 5 mm  
27.1245 28 cm / 5 mm



**CUSHING**  
27.1241 19 cm / 8 mm  
27.1246 28 cm / 8 mm

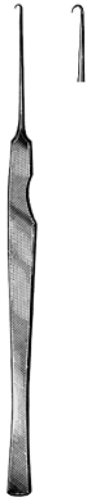

**LAHEY**  
**27.1305**  
 13 cm



**FRAZIER**



**27.1310**  
 13 cm  
 spitz  
 sharp  
 pointu  
 agudo  
 acuto



**27.1311**  
 13 cm  
 stumpf  
 blunt  
 mousse  
 romo  
 smusso



**27.1312**  
 18 cm  
 spitz  
 sharp  
 pointu  
 agudo  
 acuto



**27.1313**  
 18 cm  
 stumpf  
 blunt  
 mousse  
 romo  
 smusso



**CUSHING**  
**27.1320**  
 14 cm

schneidend  
 cutting  
 coupante  
 cortante  
 tagliente



**CUSHING**  
**27.1325**  
 14 cm



**CLOWARD**  
**27.1330**  
 16,5 cm



**TOENNIS**  
**27.1340**  
 15 cm

Gefäßhäkchen  
 Vessel Hook  
 Crochet pour vaisseaux  
 Ganchito vascular  
 Uncini vascolari

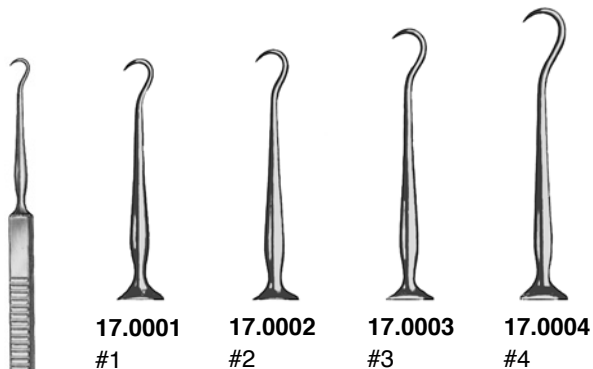

17.0001 #1  
 17.0002 #2  
 17.0003 #3  
 17.0004 #4

16 cm



**BERGMANN**  
 17.0037  
 14 cm

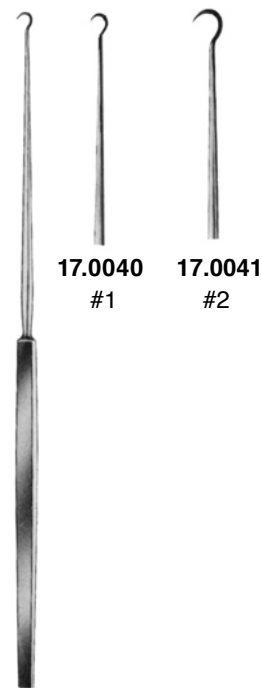

17.0040 #1  
 17.0041 #2

**GILLIES**  
 18 cm



**GILLIES**  
 17.0043 18 cm

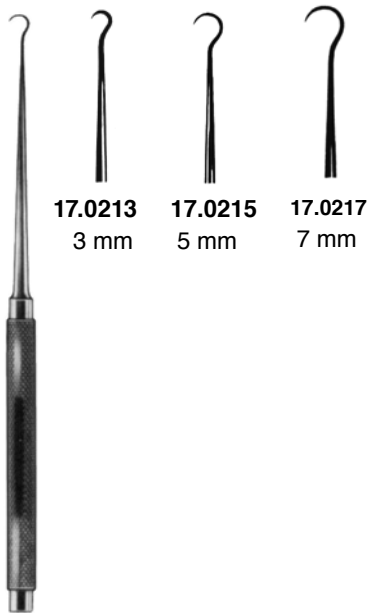

17.0213 3 mm  
 17.0215 5 mm  
 17.0217 7 mm

**KLEINERT-KUTZ**  
 13 cm



**KILNER**  
 58.0010 15,5 cm



17.0050 17.0052

Venenhäkchen  
 Vein Hooks  
 Crochets pour veines  
 Ganchitos para venas  
 Uncini per veni

**BROM**  
 19 cm



**MANNERFELT**  
 17.1901  
 13,5 cm



**MANNERFELT**  
 17.1902  
 15,5 cm



**MANNERFELT**  
 17.1904  
 15,5 cm



**MANNERFELT**  
 17.1906  
 15,5 cm



17.1908



**MANNERFELT**  
 17.1933  
 15,5 cm



17.1933  
 flexibel  
 flexible  
 flexible  
 flexible  
 flessibile



17.1911



17.1912



17.1913

**MANNERFELT**  
 15,5 cm  
 spitz  
 sharp  
 pointu  
 agudo  
 acuto



17.1916



17.1917



17.1918

**MANNERFELT**  
 15,5 cm  
 stumpf  
 blunt  
 mousse  
 romo  
 smusso



17.1921



17.1922



17.1923

**MANNERFELT**  
 15,5 cm  
 spitz  
 sharp  
 pointu  
 agudo  
 acuto



17.1926



17.1927



17.1928

**MANNERFELT**  
 15,5 cm  
 stumpf  
 blunt  
 mousse  
 romo  
 smusso



**COTTLE**  
15 cm  
33.0055 - 33.0058

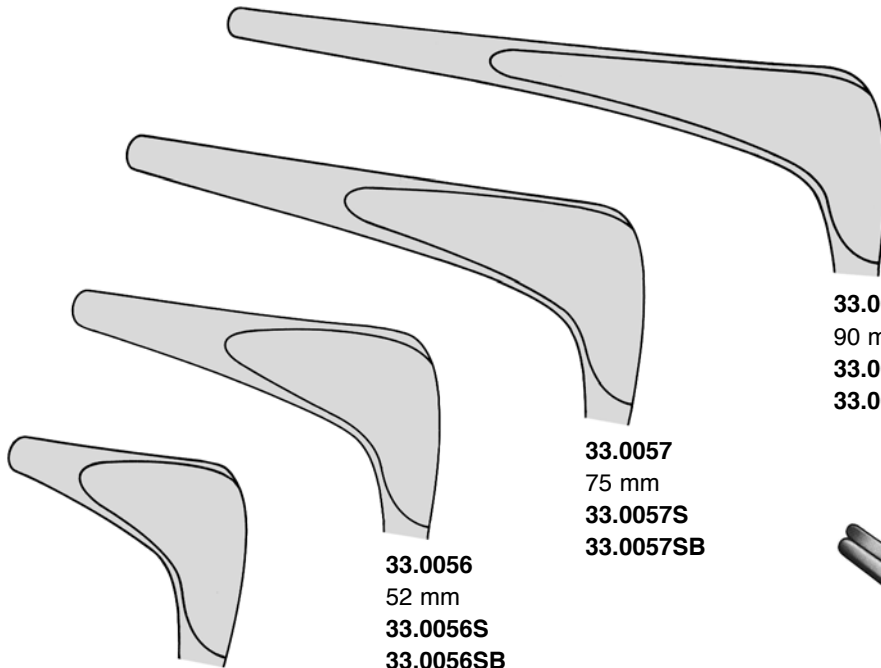

**33.0055**  
37 mm  
**33.0055S**  
**33.0055SB**

**33.0056**  
52 mm  
**33.0056S**  
**33.0056SB**

**33.0057**  
75 mm  
**33.0057S**  
**33.0057SB**

**33.0058**  
90 mm  
**33.0058S**  
**33.0058SB**

**S** = mit Fixierschraube  
with setting screw  
avec vis de blocage  
con tornillo de fijación  
da fissare con una vite

**SB** = mit Fixierschraube, SCHWARZ  
with setting screw, BLACK  
avec vis de blocage, NOIR  
con tornillo de fijación, NEGRO  
da fissare con una vite, NERO



**COTTLE**  
**33.0055S - 33.0058S**  
mit Fixierschraube  
with setting screw  
avec vis de blocage  
con tornillo de fijación  
da fissare con una vite



**COTTLE**  
14 cm

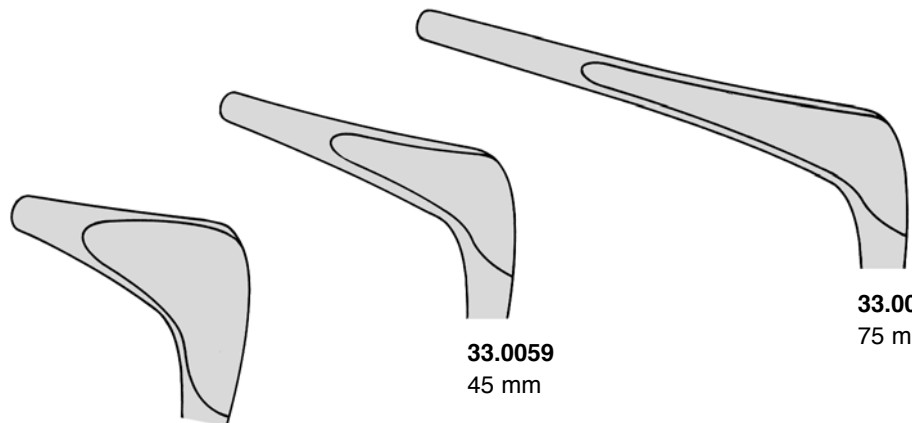

**33.0061**  
37 mm

**33.0059**  
45 mm

**33.0060**  
75 mm



**CUSHING-LANDOLT**

**33.0100** 70 x 15 mm  
**33.0101** 90 x 15 mm  
**33.0102** 110 x 15 mm



**PAPAVERO-CASPAR**

**33.0110** 80x11 mm  
**33.0112** 90x13 mm  
**33.0114** 100x15 mm



**33.0119**

Spannschlüssel für PAPAVERO-CASPAR  
Key for PAPAVERO-CASPAR  
Clé pour PAPAVERO-CASPAR  
Llave para PAPAVERO-CASPAR  
Chiave per PAPAVERO-CASPAR



**LANDOLT**

**33.0104** 21 cm





**23.1280**  
22 mm Ø  
200 g  
bleigefüllt  
lead filled  
alourdi de plomb  
relleno de plomo  
pieno di piombo

**23.1281**  
22 mm Ø  
Stahl, massiv  
steel, solid  
acier, massif  
acero, macizo  
acciaio massiccio

**PARTSCH**  
18 cm



**23.1290**  
26 mm Ø  
300 g  
bleigefüllt  
lead filled  
alourdi de plomb  
relleno de plomo  
pieno di piombo

**WILLIGER**  
24 cm

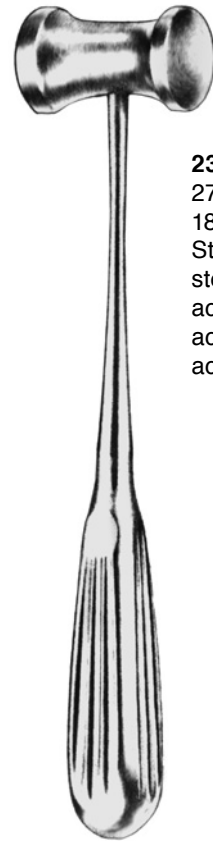

**23.1300**  
27 mm Ø  
180 g  
Stahl, massiv  
steel, solid  
acier, massif  
acero, macizo  
acciaio massiccio

**HAJEK**  
21 cm



**23.1302**  
20 mm Ø  
140 g  
bleigefüllt  
lead filled  
alourdi de plomb  
relleno de plomo  
pieno di piombo

**23.1304**  
20 mm Ø  
Stahl, massiv  
steel, solid  
acier, massif  
acero, macizo  
acciaio massiccio

**THIESS**  
16,5 cm

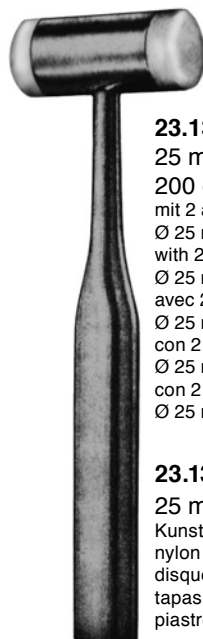

**23.1305**  
25 mm Ø  
200 g  
mit 2 auswechselbaren Nylonbacken  
Ø 25 mm, 23.1306  
with 2 interchangeable nylon disks  
Ø 25 mm, 23.1306  
avec 2 disques en nylon interchangeables  
Ø 25 mm, 23.1306  
con 2 tapas de nilón intercambiables  
Ø 25 mm, 23.1306  
con 2 piastre di nylon intercambiabili  
Ø 25 mm, 23.1306

**23.1306**  
25 mm Ø  
Kunststoffbacken allein, paarweise  
nylon disks only, pair  
disques en nylon de rechange, paire  
tapas de nilon sueltas, par  
piastre di nylon, paio

18 cm

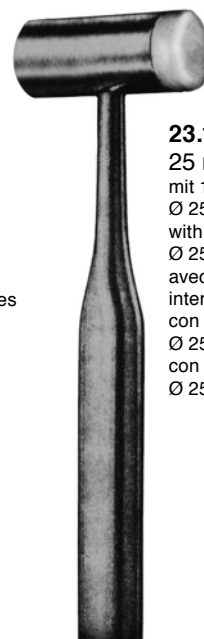

**23.1307**  
25 mm Ø  
mit 1 auswechselbaren Kunststoffbacken  
Ø 25 mm, 23.1308  
with 1 interchangeable plastic disk  
Ø 25mm, 23.1308  
avec 1 disque en matière plastique  
interchangeable Ø 25 mm, 23.1308  
con 1 tapa de plástico intercambiable  
Ø 25 mm, 23.1308  
con 1 piastra di plastica intercambiabili  
Ø 25 mm, 23.1308

18 cm

Septummeißel / Septum Chisels / Ciseaux-Burin pour la cloison nasale /  
 Cincelles para seno macilar / Scalpelli per la cavità mascellare



**COTTLE**

**33.2008** 18 cm, 4 mm  
**33.2010** 18 cm, 4 mm  
**33.2013** 18 cm, 9 mm  
**33.2014** 18 cm, 12 mm



**COTTLE**

**33.2015**  
 18 cm / 6 mm



**PAPAVERO**

**28.6610** 22 cm, 4 mm



Hypophysenpinzette  
 Hypophyseal Forceps  
 Pince pour la Hypophysectomie  
 Pinza para la hipofisectomía  
 Pinza per ipofisi

**LANDOLT**

**28.4083**  
 21,5 / 14 cm

Kehlkopfspiegel  
 Larangeal Mirrors  
 Miroirs laryngiens  
 Espejos laringeos  
 Specchi laringei



**35.0028**  
 Ø 6 mm



**35.0029**  
 Ø 8 mm



**35.0030**  
 Ø 10 mm

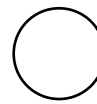

**35.0031**  
 Ø 12 mm



13,5 cm

Spiegelgriff  
 Mirror Handle  
 Manche  
 Mango  
 Manico



**35.0043**

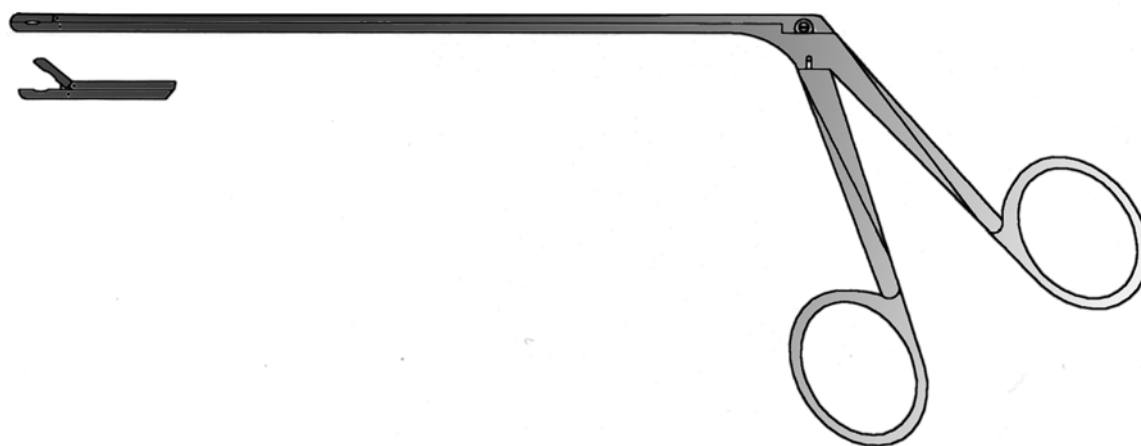

## RHOTON

15 cm

Mikrozängchen

Micro Forceps

Micro-Pince

Micro-Pinza

Mirco-Pinza



### 28.0800

Ø 1 mm  
gerade  
straight  
droite  
recto  
retto



### 28.0801

Ø 1 mm  
nach rechts gebogen  
curved right  
courbe à droite  
curva a la derecha  
curvo a destra



### 28.0803

Ø 1 mm  
nach links gebogen  
curved right  
courbe à gauche  
curva a la izquierda  
curvo a sinistra



### 28.0804

Ø 2 mm  
gerade  
straight  
droite  
recto  
retto

TITANIUM

Kürette, biegsam / Curette, malleable /  
Curette, malléable / Cucharilla, maleable /  
Curette, malleabile

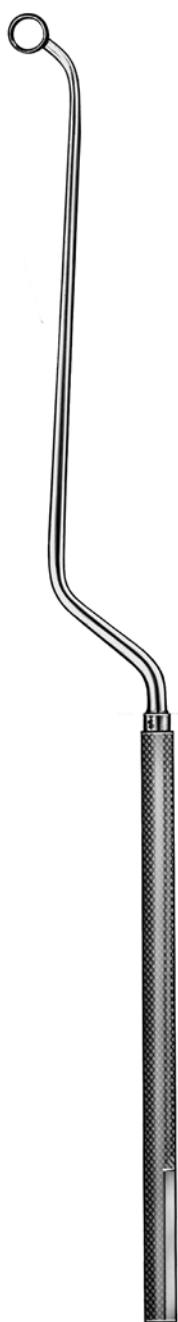

NICOLA



**28.6616** 21,5 cm  
**28.6616T** 21,5 cm

rechts gebogen  
curved right  
courbe à droite  
curva a la derecha  
curvo a destra

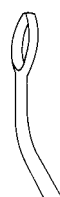

**28.6617** 21,5 cm  
**28.6617T** 21,5 cm

links gebogen  
curved left  
courbe à gauche  
curva a la izquierda  
curvo a sinistra

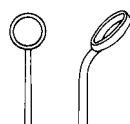

**28.6618** 21,5 cm  
**28.6618T** 21,5 cm

aufwärts gebogen  
curved up  
courbe en haut  
curva hacia arriba  
curvo in alto

Raspatorium / Raspatory /  
Raspatoire / Legra /  
Periostotomo,



**28.6619** 21,5 cm  
**28.6619T** 21,5 cm

abwärts gebogen  
curved down  
courbe vers en bas  
curva hacia arriba  
curvo in alto



NICOLA

## TITANIUM

Kürette, biegsam / Curette, malleable /  
Curette, malléable / Cucharilla, maleable /  
Curette, malleabile



**HARDY**  
26 cm



**28.6631** Ø 4 mm  
**28.6631T** Ø 4 mm

aufwärts gewinkelt  
angled up  
coudée en haut  
angolada hacia arriba  
angolate in alto



**28.6632** Ø 6 mm  
**28.6632T** Ø 6 mm

aufwärts gewinkelt  
angled up  
coudée en haut  
angolada hacia arriba  
angolate in alto



**HARDY**  
26 cm

TITANIUM

Kürette / Curette / Curette / Cucharilla / Curette



**28.6701** Ø 3mm  
**28.6702** Ø 5mm  
**28.6701T** Ø 3mm  
**28.6702T** Ø 5mm

aufwärts gewinkelt  
 angled up  
 coudée en haut  
 angolada hacia arriba  
 angolate in alto



**28.6703** Ø 3mm  
**28.6704** Ø 5mm  
**28.6703T** Ø 3mm  
**28.6704T** Ø 5mm

abwärts gewinkelt  
 angled down  
 coudée en bas  
 angolada hacia abajo  
 angolate in basso

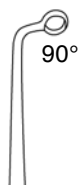

**28.6705** Ø 3mm  
**28.6706** Ø 5mm  
**28.6705T** Ø 3mm  
**28.6706T** Ø 5mm

rechts gewinkelt  
 angled right  
 coudée a droite  
 angolada hacia derecha  
 angolate a destra



**28.6716** Ø 3mm  
**28.6717** Ø 5mm  
**28.6716T** Ø 3mm  
**28.6717T** Ø 5mm

links gewinkelt  
 angled left  
 coudée à gauche  
 angolada hacia izquierda  
 angolate a sinistra

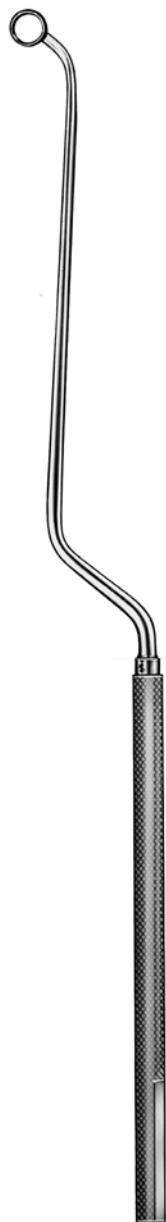

**HARDY**  
 24 cm

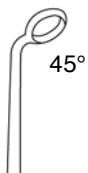

**28.6718** Ø 3mm  
**28.6719** Ø 5mm  
**28.6718T** Ø 3mm  
**28.6719T** Ø 5mm

rechts gewinkelt  
 angled right  
 coudée a droite  
 angolada hacia derecha  
 angolate a destra

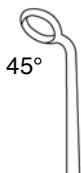

**28.6707** Ø 3mm  
**28.6708** Ø 5mm  
**28.6707T** Ø 3mm  
**28.6708T** Ø 5mm

links gewinkelt  
 angled left  
 coudée à gauche  
 angolada hacia izquierda  
 angolate a sinistra



**28.6712** Ø 3mm  
**28.6713** Ø 5mm  
**28.6712T** Ø 3mm  
**28.6713T** Ø 5mm

rechts gebogen  
 curved right  
 courbe à droite  
 curva a la derecha  
 curvo a destra

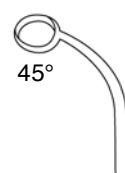

**28.6714** Ø 3mm  
**28.6715** Ø 5mm  
**28.6714T** Ø 3mm  
**28.6715T** Ø 5mm

links gebogen  
 curved left  
 courbe à gauche  
 curva a la izquierda  
 curvo a sinistra



**HARDY**  
 24 cm

## TITANIUM

Kürette / Curette / Curette / Cucharilla / Curette



**RAY**  
18 cm

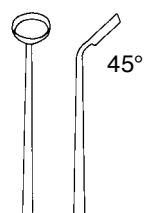

**28.6611** Ø 4mm  
**28.6611T** Ø 4mm  
 horizontal  
 horizontal  
 horizontale  
 horizontal  
 orizontale

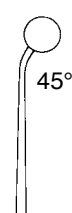

**28.6614** Ø 4mm  
**28.6614T** Ø 4mm  
 vertikal  
 vertical  
 verticale  
 vertical  
 verticale



**RAY**  
18 cm

**TITANIUM**

Enukleator / Enucleator / Enucléateur / Enucleador / Enucleatore



**HARDY**  
24,5 cm



**28.6620**  
**28.6620T**  
 stumpf, rechts  
 blunt, right  
 mousse, droite  
 roma, derecha  
 smusso, destra



**28.6621**  
**28.6621T**  
 stumpf, links  
 blunt, left  
 mousse, gauche  
 roma, izquierda  
 smusso, sinistra



**28.6622**  
**28.6622T**  
 scharf, rechts  
 sharp, right  
 coupant, droite  
 cortante, derecha  
 tagliente, destra



**28.6623**  
**28.6623T**  
 scharf, links  
 sharp, left  
 coupant, gauche  
 cortante, izquierda  
 tagliente, sinistra

Dissektor / Dissector / Dissecteur /  
 Disecador / Dissettore



**28.6608**  
**28.6608T**  
 links gebogen  
 innen scharf  
 curved to left,  
 sharp inner edge  
 courbe à gauche,  
 coupant à l'intérieur  
 curva izquierda,  
 cortante dentro  
 curva sinistra,  
 dentro affilato



**28.6609**  
**28.6609T**  
 rechts gebogen  
 innen scharf  
 curved to right  
 sharp inner edge  
 courbe à droite,  
 coupant à l'intérieur  
 curva derecha  
 cortante dentro  
 curva destra  
 dentro affilato

Implantationsgabel / Implant Fork /  
 Porte Greffon / Porte-implantates /  
 Furchetta per impiantare



**28.6624**



**HARDY**  
24,5 cm



## TITANIUM

Enucleator biegsam  
 Enucleator malleable  
 Enucleateur malléable  
 Enucleador maleable  
 Enucleatore malleabile

Kürette, biegsam  
 Curette, malleable  
 Curette, malléable  
 Cucharilla, maleable  
 Curette, malleabile

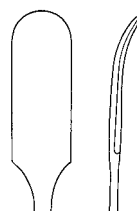

**28.6625**  
**28.6625T**

**28.6626**  
**28.6626T**

**28.6627**

stumpf, rechts  
 blunt, right  
 mousse, droite  
 roma, derecha  
 smusso, destra

stumpf, links  
 blunt, left  
 mousse, gauche  
 roma, izquierda  
 smusso, sinistra

Löffel, biegsam  
 Spoon, malleable  
 Curette, malléable  
 Cucharilla, maleable  
 Cucchiaio, malleabile

Häkchen, biegsam, stumpf  
 Hooklet, malleable, blunt  
 Crochet, malléable, mousse  
 Ganchito, maleable, romo  
 Uncino, malleabile, smusso

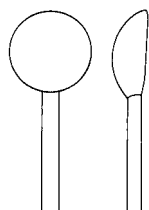

**28.6628**

**28.6629**  
**28.6629T**

Gabelspatel, fest  
 Fork-Spatula, rigid  
 Fourchette-Spatule, rigide  
 Horca-Espátula, rigido  
 Forchetta-Spatola, rigido

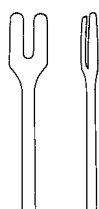

**LANDOLT**  
 26 cm

**HOSOBUCHI**  
**28.6630**



**LANDOLT**  
 26 cm

**TITANIUM**

Mikrolöffel biegsam  
 Scoop malleable  
 Cuillère malléable  
 Cucharilla maleab  
 Cucchiaino malleabile

Kürette, biegsam  
 Curette, malleable  
 Curette, malléable  
 Cucharilla, maleable  
 Curette, malleabile



**28.6635** Ø 2,0 mm  
**28.6635T** Ø 2,0 mm

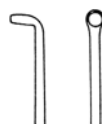

**28.6637** Ø 2,5 mm  
**28.6637T** Ø 2,5 mm

Kürette, fest  
 Curette rigid  
 Curette, rigide  
 Cucharilla, rigido  
 Curette, rigido

Raspatorium, fest  
 Raspatory, rigid  
 Rugine, rigid  
 Legras, rigido  
 Periostotomo, rigido

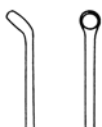

**28.6642** Ø 2,5 mm  
**28.6642T** Ø 2,5 mm

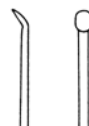

**28.6640** Ø 2,2 mm  
**28.6640T** Ø 2,2 mm

Raspatorium, fest  
 Raspatory, rigid  
 Rugine, rigid  
 Legras, rigido  
 Periostotomo, rigido

Stumpfes Häkchen, fest  
 blunt Hook, rigid  
 Crochet mousse, rigide  
 Gancho romo, rigido  
 Uncino smusso, rigido

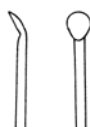

**28.6641** Ø 3,2 mm  
**28.6641T** Ø 3,2 mm



**28.6643**  
**28.6643T**

Dissektor, fest  
 Dissector, rigid  
 Dissecteur, rigide  
 Disecador rigido  
 Dissettore, rigido



**28.6644** Ø 2,0 mm  
**28.6644T** Ø 2,0 mm

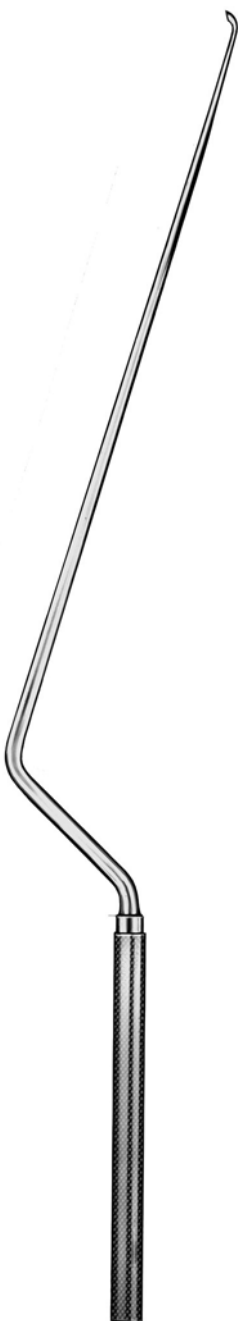

**FAHLBUSCH**  
 26 cm



**FAHLBUSCH**  
 26 cm

Saugrohre siehe Seiten 185 - 189  
 Suction- and aspirating cannulae on pages 185-189  
 Canules d'aspiration voir pages 185-189  
 Canulas para aspiración ver paginas 185-189  
 Cannule per aspirazione vedi pagine 185-189

## TITANIUM

isoliert / isolated / isolé / aislado / isolante



**CASPAR**  
24,5 cm



**27.5240** Fig. 1  
**27.5240T** Fig. 1



**27.5242** Fig. 2  
**27.5242T** Fig. 2



**27.5244** Fig. 3  
**27.5244T** Fig. 3







**27.5246** Fig. 4  
**27.5246T** Fig. 4





**CASPAR**  
24,5 cm

**TITANIUM**



			
<b>28.6330</b> 23 cm <b>28.6330T</b> 23 cm	<b>28.6331</b> 23 cm <b>28.6331T</b> 23 cm	<b>28.6375</b> 18,5 cm <b>28.6375T</b> 18,5 cm	<b>FISCH</b> <b>28.6376</b> 18,5 cm <b>28.6376T</b> 18,5 cm
scharf sharp pointu agudo acuto	stumpf blunt mousse romo smusso	scharf, gebogen sharp, curved pointu, courbe agudo, courva acuto, curvo	scharf, abgewinkelt sharp, angled pointu, coudé agudo, angulada acuto, angolato

<b>OPPEL</b> <b>28.6430</b> 23 cm <b>28.6430T</b> 23 cm
90° biegsam 90° malleable 90° malléable 90° maleable 90° malleabile

<b>OPPEL</b> <b>28.6432</b> 23 cm <b>28.6432T</b> 23 cm
45° biegsam 45° malleable 45° malléable 45° maleable 45° malleabile

<b>JACOBSON</b> <b>28.6350</b> 18,5 cm <b>28.6350T</b> 18,5 cm
Mikro-Gefäßmesser Micro Vessel Knife Micro-couteau pour vaisseaux Micro-Cuchillo para vasos Micro-coltello per vaso



## TITANIUM



**SPETZLER** 24 cm



**28.6900**  
**28.6900T**

Kugelhäkchen 30° aufw. geb.  
 Teardrop 30° cvd. up  
 Crochet boutoné, 30° coube vers haut  
 Gancho, 30° angulado hacia arriba  
 Uncino, 30° angolato in alto



**28.6911**  
**28.6911T**

Kugelhäkchen 90° aufw. geb.  
 Teardrop 90° cvd. up  
 Crochet boutoné, 90° coube vers haut  
 Gancho, 90° angulado hacia arriba  
 Uncino, 90° angolato in alto



**28.6912**  
**28.6912T**

Dissektor aufw. gebogen  
 Dissector curved up  
 Courbe vers haut  
 Disecador, curva hacia arriba  
 Dissetore, curva in alto



**SPETZLER** 24 cm



18,5 cm



**YASARGIL**  
28.6270



**YASARGIL**  
28.6271



**YASARGIL**  
28.6272



**YASARGIL**  
28.6273

Fadenführer geknöpft / Ligature Guide, buttoned / Guide-fils, boutonné /  
Guia-ligaduras, abotonado / Guida-ligature, bottonuta



**KRAYENBÜHL**  
28.6396



**KRAYENBÜHL**  
28.6397



**KRAYENBÜHL**  
28.6398



**KRAYENBÜHL**  
28.6399

Nerv- und Gefäßhäkchen / Nerve- and Vessel Hook / Crochet à nerfs et vaisseaux /  
Ganchito para nervios e vasos / Uncini per nervi e vasi

**PRO-MED** ist Ihnen behilflich bei der Zusammenstellung von Operationsbestecken für die verschiedensten Disziplinen. Fragen Sie nach unseren vorbereiteten OP-Bestecken.

For your convenience a wide variety of Suggested Operating Sets for most general and specialized procedures is available from **PRO-MED**. Please contact us or your local dealer.

**PRO-MED** vous propose de multiples compositions de boîtes opératoires multidisciplinaires. Demandez nos suggestions pour de nombreuses interventions.

**PRO-MED** le ayuda en componer varias cajas de instrumentos quirúrgicos. Pregunte por nuestro instrumental quirúrgico preparado.

Per la vostra comodità **PRO-MED** Vi aiuta nella raccolta di strumenti chirurgici per le varie discipline. Vi preghiamo di chiedere informazioni sui nostri set di strumenti chirurgici già preparati.



**LAHEY**  
27.1305  
13 cm



**FRAZIER**



**27.1310**  
13 cm  
spitz  
sharp  
pointu  
agudo  
acuto



**27.1311**  
13 cm  
stumpf  
blunt  
mousse  
romo  
smusso



**CAIRNS**  
27.1300  
13 cm



**MÜLLER**  
27.1301  
15 cm



**MÜLLER**  
27.1302  
15 cm



**CUSHING**  
27.1320  
14 cm



**CUSHING**  
27.1325  
14 cm



**CLOWARD**  
27.1330  
16,5 cm



**TOENNIS**  
27.1340  
15 cm

**TITANIUM**

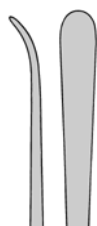

**CASPAR**  
 28.6303  
 28.6303T  
 23 cm, 4,5 mm

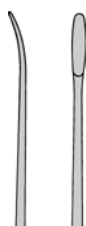

28.6333  
 28.6333T  
 23 cm, 2 mm

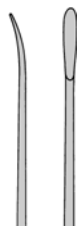

28.6334  
 28.6334T  
 23 cm, 1,8 mm



28.6332  
 28.6332T  
 23 cm, 1,4 mm



**OPPEL**  
 28.6429  
 28.6429T  
 23 cm, 1 mm  
 biegsam  
 malleable  
 malléable  
 maleable  
 malleabile



28.6310  
 28.6310T  
 20 cm, 1 mm



40.3160  
 40.3160T  
 18,5 cm, 3 mm



40.3162  
 40.3162T  
 21,5 cm, 3 mm



**YASARGIL**  
 28.6302  
 28.6302T  
 18,5 cm





## TITANIUM



**CASPAR**  
**28.6311**  
**28.6311T**

23 cm, 1 mm  
 aufwärts gebogen  
 curved up  
 courbe vers haut  
 curva hacia arriba  
 curva in alto



**CASPAR**  
**28.6312**  
**28.6312T**

23 cm, 1 mm  
 abwärts gebogen  
 curved down  
 courbe vers bas  
 curva hacia abajo  
 curva in basso



**28.6343**  
**28.6343T**

23 cm, 1,8 mm  
 aufwärts gebogen  
 curved up  
 courbe vers haut  
 curva hacia arriba  
 curva in alto



**28.6344**  
**28.6344T**

23 cm, 1,8 mm  
 abwärts gebogen  
 curved down  
 courbe vers bas  
 curva hacia abajo  
 curva in basso



**CASPAR**  
**28.6307**  
**28.6307T**

23 cm, 2 mm  
 abwärts gebogen  
 curved down  
 courbe vers bas  
 curva hacia abajo  
 curva in basso



**CASPAR**  
**28.6305**  
**28.6305T**

23 cm, 4,5 mm  
 abwärts gebogen  
 curved down  
 courbe vers bas  
 curva hacia abajo  
 curva in basso



TITANIUM



**YASARGIL**

**28.6301**

**28.6301T**

18,5 cm

abgewinkelt / angled / coudée / angolada / angolate

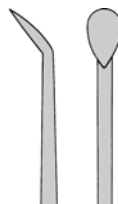

**YASARGIL**

**28.6003**

**28.6003T**

18,5 cm



**YASARGIL**

**28.6304**

**28.6304T**

18,5 cm

schwach gebogen  
slightly curved  
légèrement courbe  
ligero curvo  
curvato leggero



**YASARGIL**

**28.6005**

**28.6005T**

18,5 cm

stark gebogen  
strongly curved  
fortement courbe  
multo curva  
molto curve

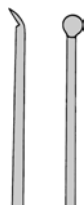

**28.6337**

**28.6337T**

23 cm

rund / circular / circulaire / circular / tondo

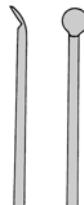

**28.6338**

**28.6338T**

23 cm



## TITANIUM

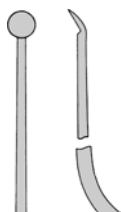

**28.6346**  
**28.6346T**

23 cm  
 aufgewinkelt  
 angled up  
 coudée vers haut  
 angolada arriba  
 angolato in alto



**YASARGIL**  
**28.6320**  
**28.6320T**

18,5 cm  
 abgebogen  
 curved down  
 courbe vers bas  
 curva hacia abajo  
 curva in basso

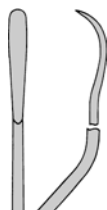

**YASARGIL**  
**28.6321**  
**28.6321T**

18,5 cm  
 abgebogen  
 curved down  
 courbe vers bas  
 curva hacia abajo  
 curva in basso

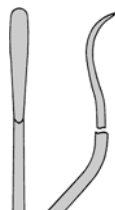

**YASARGIL**  
**28.6322**  
**28.6322T**

18,5 cm  
 aufgebogen  
 curved up  
 courbe vers haut  
 curva hacia arriba  
 curva in alto



TITANIUM



28.6335  
28.6335T

23 cm  
gerade  
straight  
droite  
recto  
retto



28.6336  
28.6336T

23 cm  
gebogen  
curved  
coube  
curva  
curvo



YASARGIL  
28.6325

18,5 cm  
baionettförmig  
bayonet shaped  
en forme de baïonnette  
en forma de bayoneta  
forma di baionetta



## TITANIUM



**28.6688**  
**28.6688T**

Fig. 9  
 Häkchen halbscharf 90°  
 Semi-sharp Hook 90°  
 Crochet demipointu 90°  
 Ganchito demiagudo 90°  
 Uncino demi-acuto 90°



**28.6689**  
**28.6689T**

Fig. 10  
 10 Häkchen stumpf 90°  
 blunt Hook 90°  
 Crochet mousse 90°  
 Ganchito romo 90°  
 Uncino smusso 90°



**28.6690**  
**28.6690T**

Fig. 11  
 Häkchen halbscharf 45°  
 Semi-sharp Hook 45°  
 Crochet demipointu 45°  
 Ganchito demiagudo 45°  
 Uncino demi-acuto 45°



**28.6691**  
**28.6691T**

Fig. 12  
 Nadel gerade  
 Straight Point Needle  
 Aguille, droite  
 Aguja, recto  
 Ago retto



**28.6692**  
**28.6692T**

Fig. 13  
 Kürette, klein  
 Curette, small  
 Curette, petite  
 Cucharilla, pequeño  
 Curetta piccola



**28.6693**  
**28.6693T**

Fig. 14  
 Kürette, groß  
 Curette, large  
 Curette, grande  
 Cucharilla, grande  
 Curetta grande



**28.6679**  
**28.6679T**

Fig. 15  
 gerade  
 straight  
 droit  
 recto  
 retto



**28.6696**  
**28.6696T**

Fig. 16  
 3 mm 90°



**28.6697**  
**28.6697T**

Fig. 17  
 5 mm 90°



**28.6698**  
**28.6698T**

Fig. 18  
 4 mm 40°



**28.6699**  
**28.6699T**

Fig. 19  
 8 mm 40°

Kugeldissektor / Teardrop Dissector / Dissecteur à boule / Disecador de bola / Dissettore a sfera

19 cm

19 cm

TITANIUM



SAMII



- 28.6400 20 cm, 1,0 mm
- 28.6410 23 cm, 1,0 mm
- 28.6400T 20 cm, 1,0 mm
- 28.6410T 23 cm, 1,0 mm

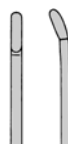

- 28.6401 20 cm, 1,5 mm
- 28.6411 23 cm, 1,5 mm
- 28.6401T 20 cm, 1,5 mm
- 28.6411T 23 cm, 1,5 mm



- 28.6402 20 cm, 2,0 mm
- 28.6412 23 cm, 2,0 mm
- 28.6402T 20 cm, 2,0 mm
- 28.6412T 23 cm, 2,0 mm



- 28.6403 20 cm, 2,5 mm
- 28.6413 23 cm, 2,5 mm
- 28.6403T 20 cm, 2,5 mm
- 28.6413T 23 cm, 2,5 mm



- 28.6404 20 cm, 3,0 mm
- 28.6414 23 cm, 3,0 mm
- 28.6404T 20 cm, 3,0 mm
- 28.6414T 23 cm, 3,0 mm



- 28.6405 20 cm, 3,5 mm
- 28.6415 23 cm, 3,5 mm
- 28.6405T 20 cm, 3,5 mm
- 28.6415T 23 cm, 3,5 mm



- 28.6406 20 cm, 4,0 mm
- 28.6416 23 cm, 4,0 mm
- 28.6406T 20 cm, 4,0 mm
- 28.6416T 23 cm, 4,0 mm



- 28.6408 20 cm, 5,0 mm
- 28.6418 23 cm, 5,0 mm
- 28.6408T 20 cm, 5,0 mm
- 28.6418T 23 cm, 5,0 mm



SAMII

## TITANIUM



SAMII



28.6851 20 cm, 1,0 mm  
28.6861 23 cm, 1,0 mm  
28.6851T 20 cm, 1,0 mm  
28.6861T 23 cm, 1,0 mm

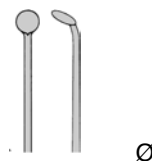

28.6854 20 cm, 3,0 mm  
28.6864 23 cm, 3,0 mm  
28.6854T 20 cm, 3,0 mm  
28.6864T 23 cm, 3,0 mm

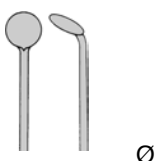

28.8656 20 cm, 4,5 mm  
28.8666 23 cm, 4,5 mm  
28.8656T 20 cm, 4,5 mm  
28.8666T 23 cm, 4,5 mm

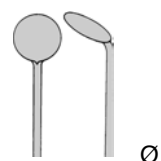

28.2858 20 cm, 6,0 mm  
28.2868 23 cm, 6,0 mm  
28.2858T 20 cm, 6,0 mm  
28.2868T 23 cm, 6,0 mm

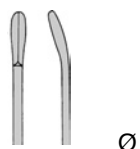

28.6298 23 cm, 1,8 mm  
28.6298T 23 cm, 1,8 mm

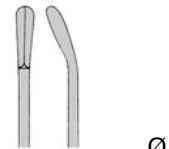

28.6299 23 cm, 2,5 mm  
28.6299T 23 cm, 2,5 mm

Lanzettenmesser / Lancet Knife / Couteau lancéolair /  
Cuchillo lanceolar / Coltello lanceolato



OPEL Ø  
28.6427 23 cm, 2,0 mm  
28.6427T 23 cm, 2,0 mm

Lanzettenmesser biegsam  
Lancet Knife malleable  
Couteau lancéolair maléable  
Cuchillo lanceolar maleable  
Coltello lanceolato malleabile



SAMII

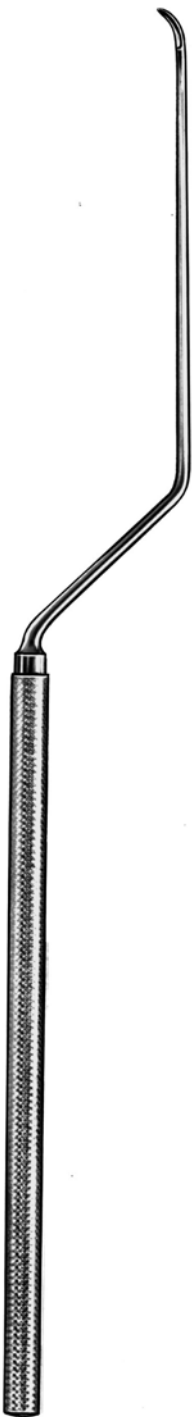

18,5 cm



**KOOS**  
**28.6351**  
aufwärts gebogen  
curved up  
courbe vers haut  
curva hacia arriba  
curva in alto



**KOOS**  
**28.6352**  
abgebogen  
curved down  
courbe vers bas  
curva hacia abajo  
curva in basso



**KOOS**  
**28.6353**  
aufwärts gebogen  
curved up  
courbe vers haut  
curva hacia arriba  
curva in alto



**KOOS**  
**28.6354**  
abgebogen  
curved down  
courbe vers bas  
curva hacia abajo  
curva in basso



**KOOS**  
**28.6356**  
abgebogen  
curved down  
courbe vers bas  
curva hacia abajo  
curva in basso



**KOOS**  
**28.6357**  
aufwärts gebogen  
curved up  
courbe vers haut  
curva hacia arriba  
curva in alto



**YASARGIL**  
**28.6365**  
abgebogen  
curved down  
courbe vers bas  
curva hacia abajo  
curva in basso



**YASARGIL**  
**28.6366**  
aufwärts gebogen  
curved up  
courbe vers haut  
curva hacia arriba  
curva in alto





**28.6362** 9,5 cm  
Gefäßmesser  
Vessel Knife  
Couteau pour vaisseaux  
Cuchillo para vasos  
Coltello per vasi



**28.6363** 9,5 cm  
Gefäßhäkchen  
Vessel Hook  
Crochet pour vaisseaux  
Gancho para vasos  
Uncino per vasi



**28.6361** 10,5 cm  
Griff mit Spannfutter  
Handle with chuck  
Manche avec mandrin  
Manfo con mandril  
Manico con mandrino



**JACOBSON**  
 28.6315 18,5 cm

**CASPAR**  
 28.6309 23 cm

Fadengabel / Suture Pusher / Fourche à fils /  
 Empujador de sutura / Punzoni per sutura

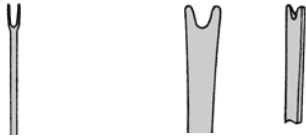

GewebekralLEN  
 Tissue Picks  
 Crochets double pour tissu  
 Unas doble para tejidos  
 Uncini doppi per tessuti

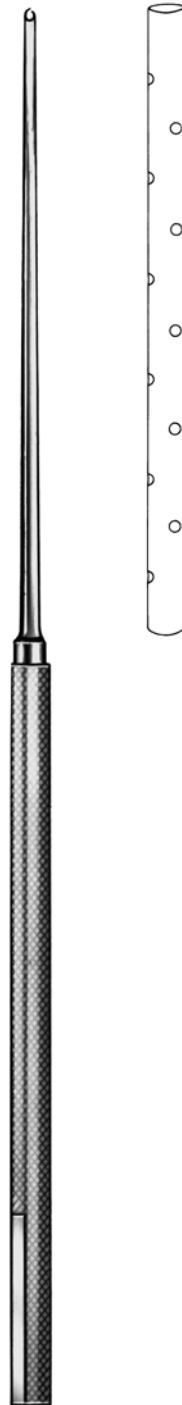

**28.6392** 18,5 cm

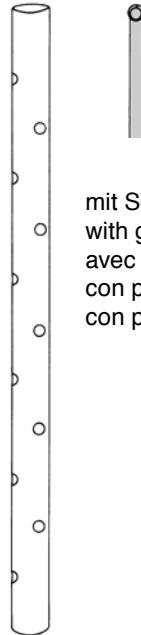

mit Schutz  
 with guard  
 avec protecteur  
 con protector  
 con protezione



**30.0570**  
 rechts  
 right  
 à droite  
 derecha  
 destra



**30.0571**  
 links  
 left  
 à gauche  
 izquierda  
 sinistra

11 cm



23 cm



**OKONEK-YASARGIL**  
28.6380 3 mm



**OKONEK-YASARGIL**  
28.6381 4 mm



**OKONEK-YASARGIL**  
28.6382 5 mm



**OKONEK-YASARGIL**  
28.6384 8 mm



**28.6385** 5 mm



**28.6388** 8 mm

**PRO-MED** ist Ihnen behilflich bei der Zusammenstellung von Operationsbestecken für die verschiedensten Disziplinen. Fragen Sie nach unseren vorbereiteten OP-Bestecken.

For your convenience a wide variety of Suggested Operating Sets for most general and specialized procedures is available from **PRO-MED**. Please contact us or your local dealer.

**PRO-MED** vous propose de multiples compositions de boîtes opératoires multidisciplinaires. Demandez nos suggestions pour de nombreuses interventions.

**PRO-MED** le ayuda en componer varias cajas de instrumentos quirúrgicos. Pregunte por nuestro instrumental quirúrgico preparado.

Per la vostra comodità **PRO-MED** Vi aiuta nella raccolta di strumenti chirurgici per le varie discipline. Vi preghiamo di chiedere informazioni sui nostri set di strumenti chirurgici già preparati.



**BIEMER**  
**20.6010**  
16 cm



**28.6306**  
12,5 cm, Ø 0,5 mm



**28.6307**  
12,5 cm, Ø 1,0 mm



**28.6308**  
12,5 cm, Ø 1,5 mm



**JACOBSON**  
**28.6011**  
18,5 cm



**JACOBSON**  
**28.6012**  
18,5 cm