

MUND, ZUNGE, TONSILLEKTOMIE
MOUTH, THROAT, TONSILLECTOMY
BOUCHE, LANGUE, AMYGDALECTOMIE
BOCA Y LENGUA, AMIGDALECTOMIA
BOCCA, LINGUA, TONSILLECTOMIA

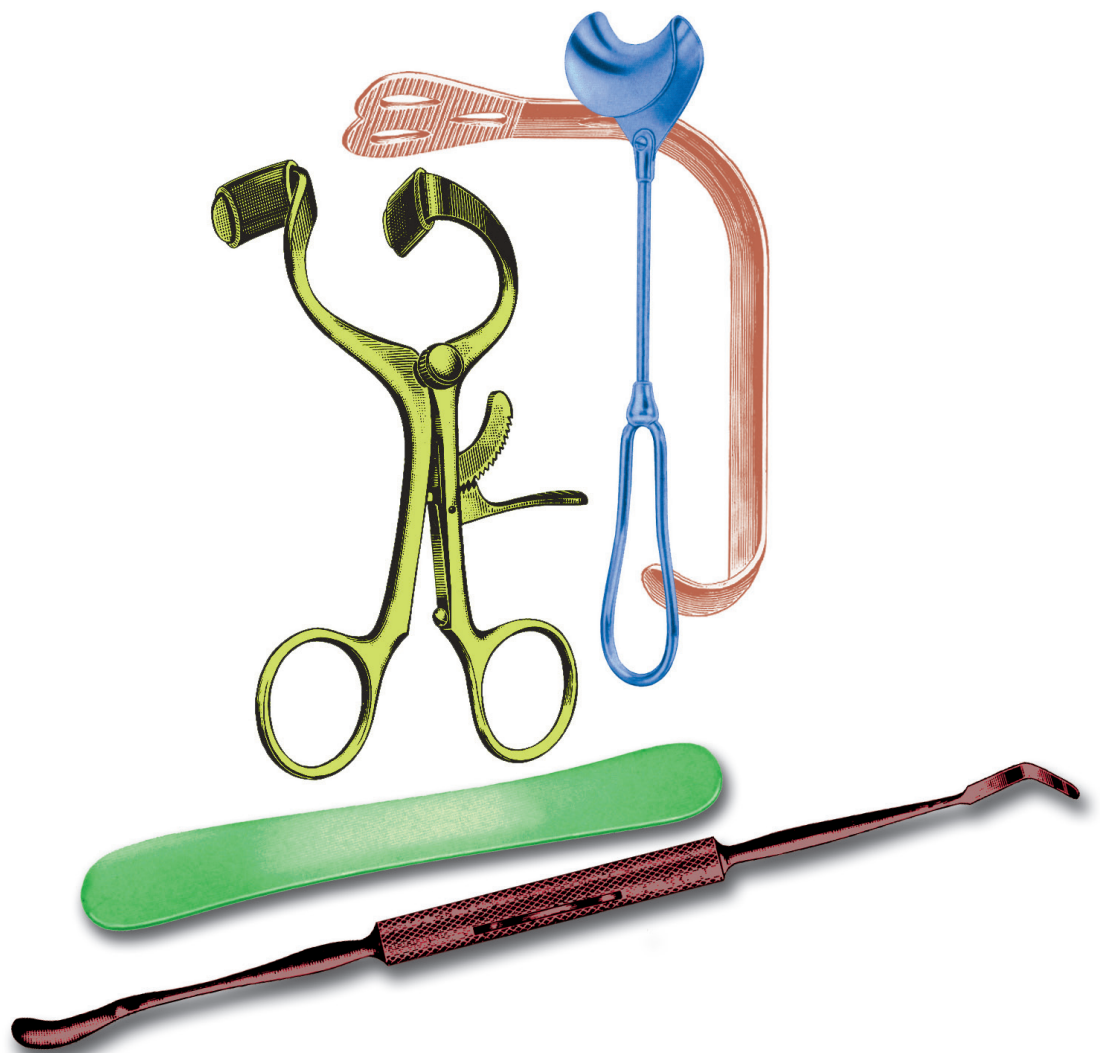

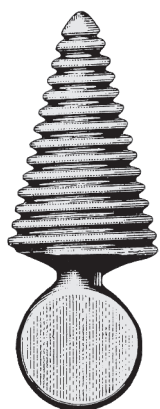

MAUNDER
34.0001
10 cm

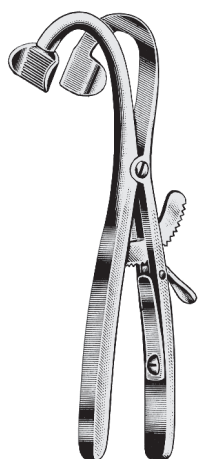

DENHART
34.0004
12 cm

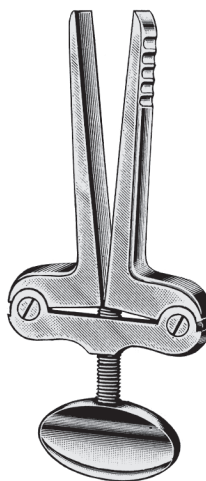

HEISTER
34.0005
13 cm



DOYEN-JANSEN
34.0010
12 cm

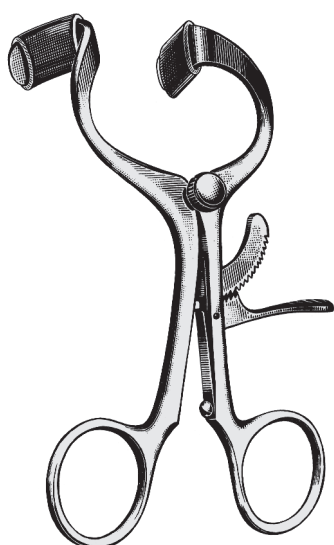

DOYEN-JANSEN
34.0011
14 cm

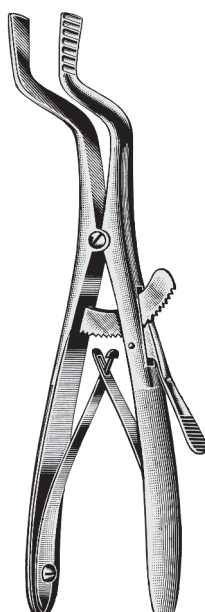

ROSER-KOENIG
34.0016 16 cm
34.0019 19 cm



34.0020
14,5 cm



34.0021
14,5 cm



UNIV. MINNESOTA
34.0024
14 cm



KROENIG
34.0025
15 cm



MAYO
34.0027
17 cm



BUCHWALD
34.0028
18 cm



BRUENINGS
34.0029
19 cm



ANDREW
34.0031
11 cm

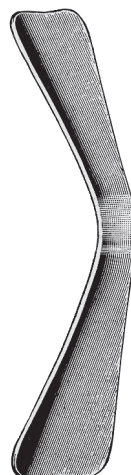

DOYEN
34.0033 13 cm
34.0036 16 cm

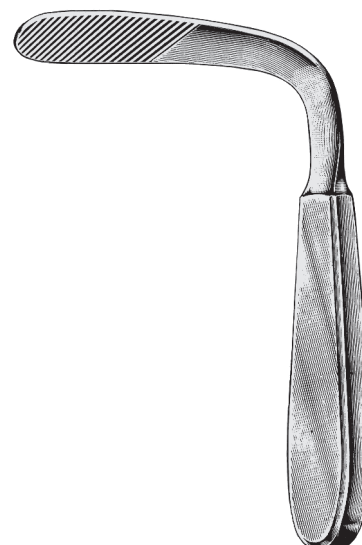

TOBOLD
34.0044
14,5 cm



BOSWORTH
34.0045
14,5 cm



HARTMANN
34.0046
14,5 cm



LE MEE
34.0047
20 cm



WIEDER



34.0050
#1 35 mm



34.0051
#2 40 mm

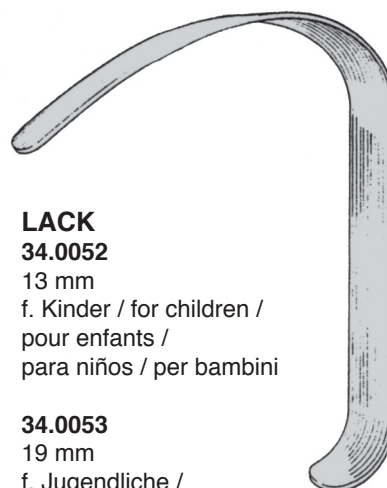

LACK
34.0052
13 mm
f. Kinder / for children /
pour enfants /
para niños / per bambini

34.0053
19 mm
f. Jugendliche /
for juveniles / pour adolescents /
para adolescentes / per giovane

34.0054
22 mm
f. Erwachsene / for adults /
pour adultes / para adultos /
per adulti



34.0055
 15 cm
 Plastik
 plastic
 matière synthétique
 plástico
 sintetico

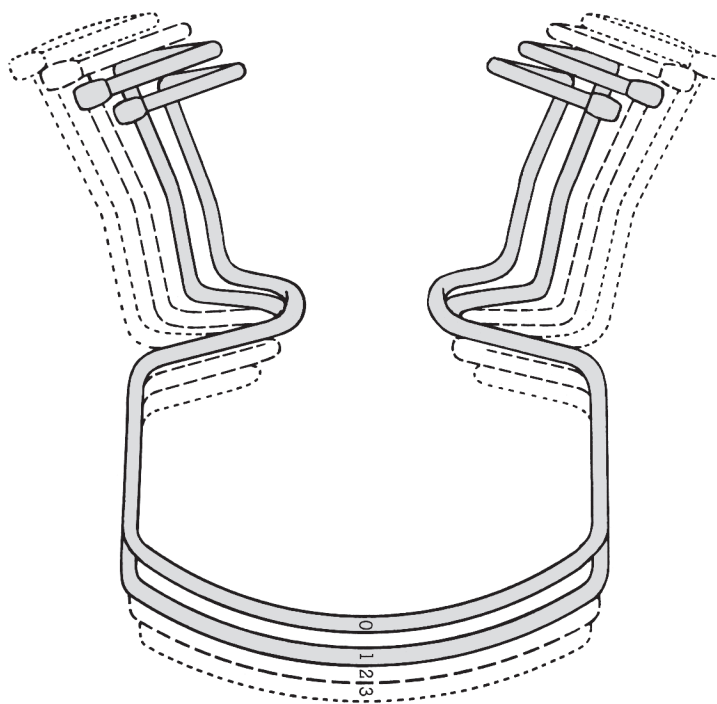

ORINGER
34.0056 Fig. 0, 9,5 cm, 95 mm
 für Kinder / for children / pour enfants /
 para niños / per bambini
34.0057 Fig. 1, 10 cm, 110 mm
34.0058 Fig. 2, 10,5cm, 115 mm
34.0059 Fig. 3, 11 cm, 120 mm



STERNBERG
34.0061 12 cm
34.0062 14 cm
34.0063 16 cm

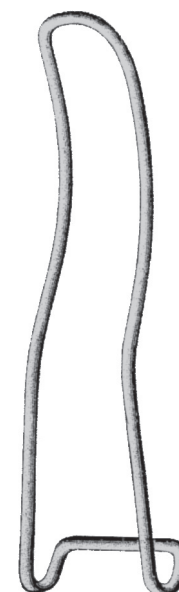

STERNBERG
34.0064 14 cm
34.0065 16 cm
34.0066 18 cm

34.0060
 Satz / Set / Jeu / Juego / Set Fig. 1-3



34.0070
 19 cm

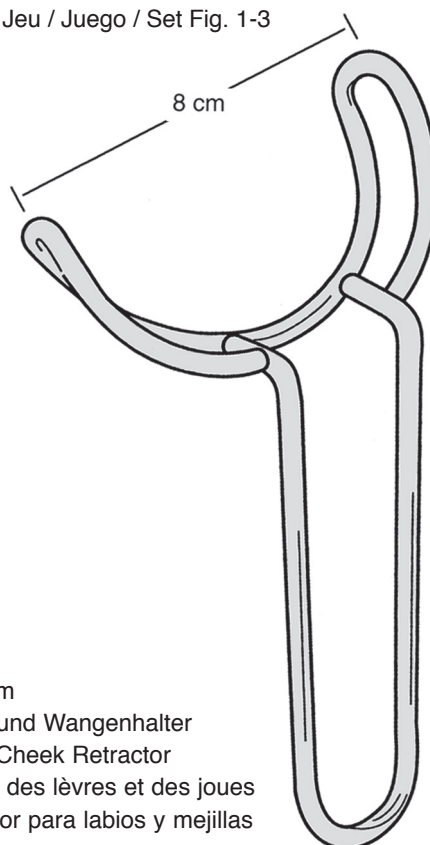

34.0076
 14 x 8 cm
 Lippen- und Wangenhalter
 Lip and Cheek Retractor
 Ecarteur des lèvres et des joues
 Separador para labios y mejillas
 ital...

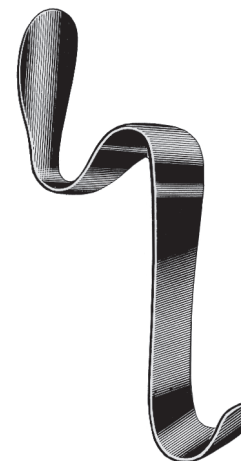

BISHOP
34.0080
 13 cm

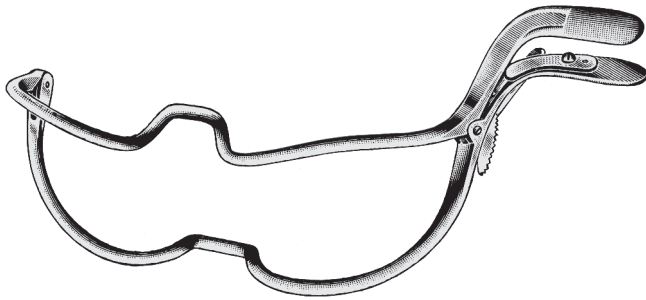

JENNINGS
34.0100 9 cm
34.0101 11 cm
34.0102 13 cm
34.0103 15 cm

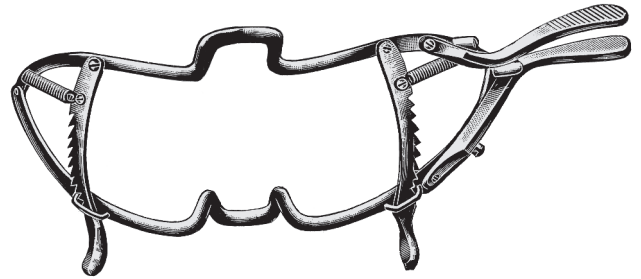

WHITEHEAD
34.0120 9 cm
34.0121 11 cm
34.0122 13 cm
34.0123 15 cm

alle Rahmen und Zungendrucker sind untereinander austauschbar
all frames and tongue blades are interchangeable
Tous les cadres et abaisses-langues sont interchangeables
Todos los bastidores y bajalenguas son intercambiables
Tutti i telai ed abbassalingua sono intercambiabili



34.0149
Ersatz Silikon-Einlage /
Spare silicone insert / Plaque
de rechange en silicone /
Plantilla de silicona de repu-
esto / Plastre di ricambio in
solicone



34.0142
21 x 25 mm

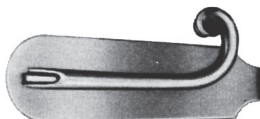

34.0143
23 x 65 mm

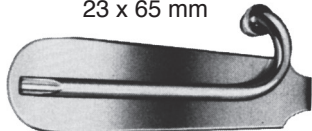

34.0144
24 x 80 mm

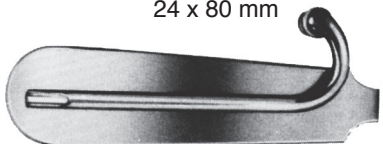

34.0145
25 x 93 mm



34.0146
26 x 108 mm

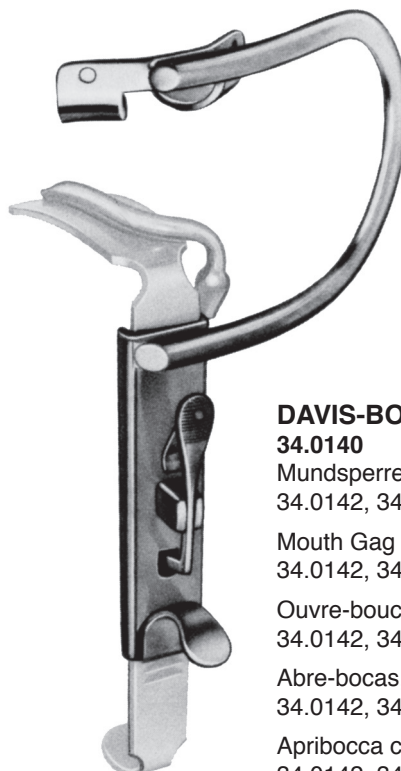

DAVIS-BOYLE
34.0141

Rahmen für Erwachsene /
Frame for adults / Cadre pour adultes /
Bastidor para adultos / Telaio per adulti

34.0148

Rahmen für Kinder / Frame for children /
cadre pour enfants / bastidor para niño /
telaio per bambini

DAVIS-BOYLE

34.0140

Mundsperrer komplett mit 5 Zungendrückern
34.0142, 34.0143, 34.0144, 34.0145, 34.0146

Mouth Gag complete with 5 Tongue Depressors
34.0142, 34.0143, 34.0144, 34.0145, 34.0146

Ouvre-bouche, complet avec 5 spatules
34.0142, 34.0143, 34.0144, 34.0145, 34.0146

Abre-bocas, complet con 5 spatulas
34.0142, 34.0143, 34.0144, 34.0145, 34.0146

Apribocca completo con 5 spatole
34.0142, 34.0143, 34.0144, 34.0145, 34.0146

alle Rahmen und Zungendrucker sind untereinander austauschbar
all frames and tongue blades are interchangeable
Tous les cadres et abaisses-langues sont interchangeables
Todos los bastidores y bajalenguas son intercambiables
Tutti i telai ed abbassalingua sono intercambiabili

DAVIS-MEYER

34.0150

Mundsperrer komplett mit 7 Zungendrückern 34.0152, 34.0153, 34.0154, 34.0155, 34.0156, 34.0157, 34.0158

Mouth Gag complete with 7 Tongue Depressors 34.0152, 34.0153, 34.0154, 34.0155, 34.0156, 34.0157, 34.0158

Ouvre-bouche, complet avec 7 spatules 34.0152, 34.0153, 34.0154, 34.0155, 34.0156, 34.0157, 34.0158

Abre-boca, complet con 7 espátulas 34.0152, 34.0153, 34.0154, 34.0155, 34.0156, 34.0157, 34.0158

Apribocca completo con 7 spatole 34.0152, 34.0153, 34.0154, 34.0155, 34.0156, 34.0157, 34.0158



DAVIS-MEYER

34.0151

Rahmen alleine
Gag only
Cadre seul
Cuadro suelto
Telaio solo

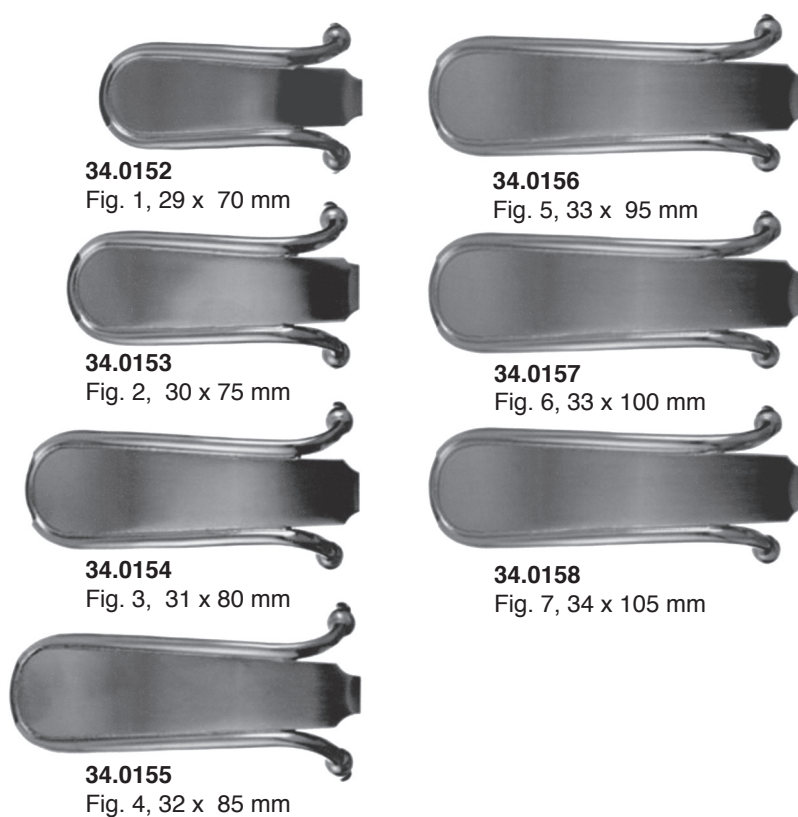

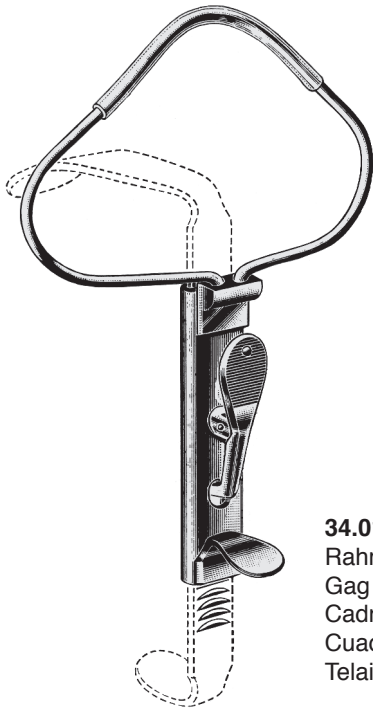

34.0161
Rahmen alleine
Gag only
Cadre seul
Cuadro suelto
Telaio solo



34.0162
23 x 70 mm



34.0163
25 x 86 mm



34.0164
26 x 100 mm

McIVOR
34.0159

Rahmen für Kinder
Frame for children
cadre pour enfants
bastidor para niños
telaio per bambini

MCIVOR

34.0160

Mundsperrer komplett mit 3 Zungendrückern 34.0162, 34.0163, 34.0164
Mouth Gag complete with 3 Tongue Depressors 34.0162, 34.0163, 34.0164
Ouvre-bouche, complet avec 3 spatules 34.0162, 34.0163, 34.0164
Abre-boca, complet con 3 espátulas 34.0162, 34.0163, 34.0164
Apribocca completo con 3 spatole 34.0162, 34.0163, 34.0164

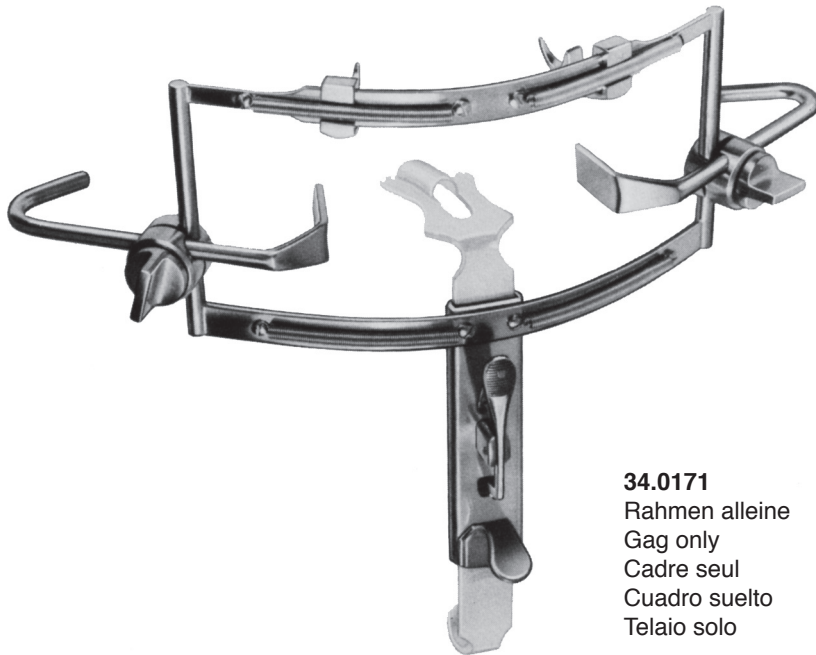

34.0171
Rahmen alleine
Gag only
Cadre seul
Cuadro suelto
Telaio solo

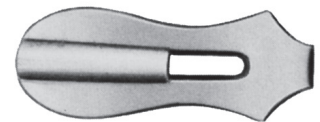

34.0172 #1
24 x 62 mm

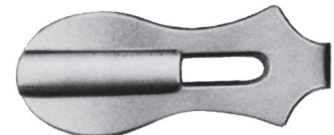

34.0173 #2
28 x 65 mm

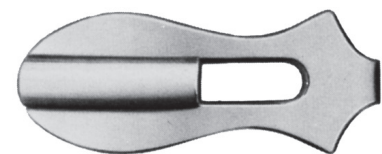

34.0174 #3
31 x 75 mm

DINGMAN

34.0170

Mundsperrer komplett mit 3 Zungendrückern 34.0172, 34.0173, 34.0174
Mouth Gag complete with 3 Tongue Depressors 34.0172, 34.0173, 34.0174
Ouvre-bouche, complet avec 3 spatules 34.0172, 34.0173, 34.0174
Abre-boca, complet con 3 espátulas 34.0172, 34.0173, 34.0174
Apribocca completo con 3 spatole 34.0172, 34.0173, 34.0174

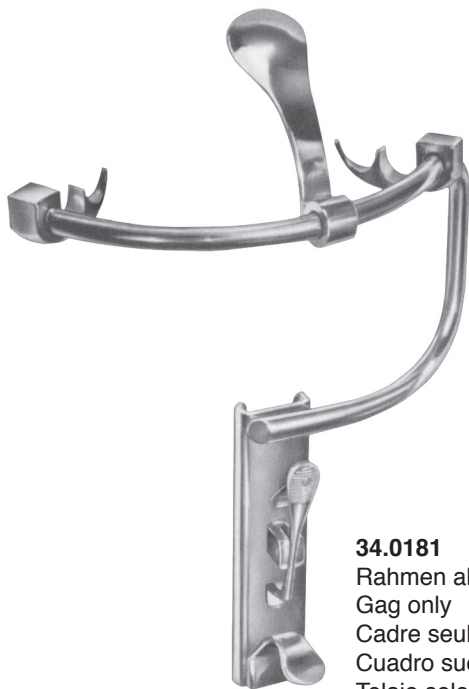

34.0181
Rahmen alleine
Gag only
Cadre seul
Cuadro suelto
Telaio solo



34.0182 #1
28 x 65 mm



34.0183 #2
32 x 75 mm

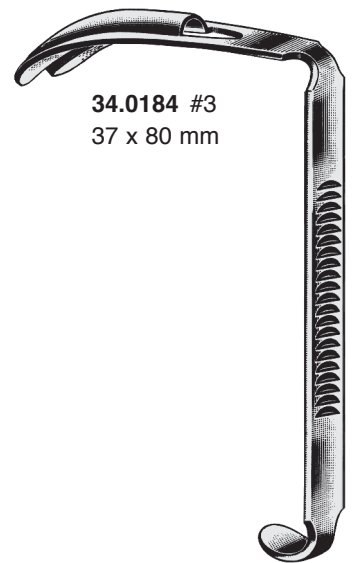

34.0184 #3
37 x 80 mm

KILNER-DAUGHTY

34.0180

Mundsperrer komplett mit 3 Zungendrückern 34.0182, 34.0183, 34.0184
Mouth Gag complete with 3 Tongue Depressors 34.0182, 34.0183, 34.0184
Ouvre-bouche, complet avec 3 spatules 34.0182, 34.0183, 34.0184
Abre-boca, complet con 3 espátulas 34.0182, 34.0183, 34.0184
Apribocca completo con 3 spatole 34.0182, 34.0183, 34.0184

alle Rahmen und Zungendrucker sind untereinander austauschbar
all frames and tongue blades are interchangeable
Tous les cadres et abaisses-langues sont interchangeables
Todos los bastidores y bajalenguas son intercambiables
Tutti i telai ed abbassalingua sono intercambiabili



DAUGHTY (WÜRZBURG)

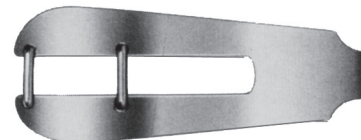

34.0190
Fig.1, 28 x 66 mm

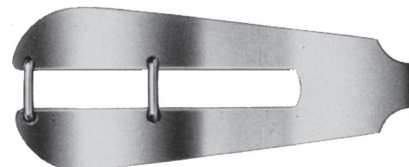

34.0191
Fig.2, 32 x 75 mm

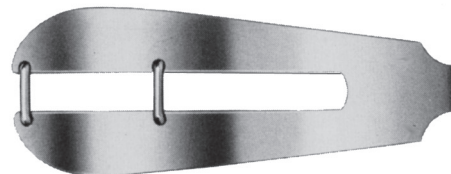

34.0192
Fig.3, 34 x 83 mm

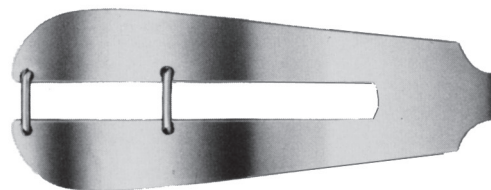

34.0193
Fig.4, 37 x 93 mm

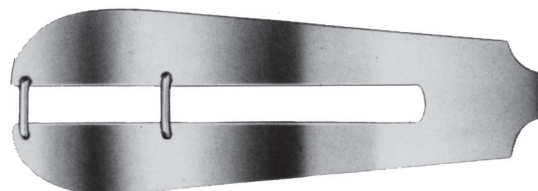

34.0194
Fig.5, 38 x 100 mm



RUSSEL-DAVIS



34.0231 #1
29 x 67 mm



34.0234 #4
40 x 92 mm



34.0236
18 x 55 mm



34.0232 #2
33 x 75 mm



34.0235 #5
46 x 100 mm



34.0237
22 x 65 mm



34.0233 #3
38 x 85 mm



34.0238
25 x 75 mm

schmal narrow / étroit /
estrecho / stretto

alle Rahmen und Zungendrucker sind untereinander austauschbar
all frames and tongue blades are interchangeable
Tous les cadres et abaisses-langues sont interchangeables
Todos los bastidores y bajalenguas son intercambiables
Tutti i telai ed abbassalingua sono intercambiabili



34.0251 #2
23 x 58 mm



34.0256



34.0252 #3
27 x 72 mm



34.0257



34.0253 #4
34 x 87 mm



34.0258



34.0254 #5
37 x 95 mm



34.0259

links
left
gauche
izquierda
sinistra

rechts
right
droite
derecha
destra



RING

Bipod für Mundsperrer
Bipod for mouth gags
Bipod pour ouvre-bouche
Bipodpara abre-boca
Bipod per apribocca

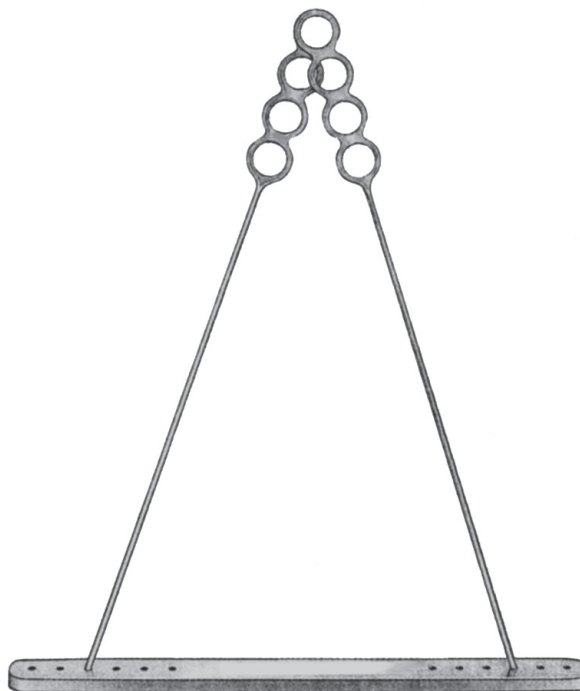

DRAFFIN
34.0290

Bruststütze für Mundsperrer
Chest Supports for mouth gags
Supports de poitrine pour ouvre-bouche
Soporte de pecho para abre bocas
Sopporti per petto per apribocca

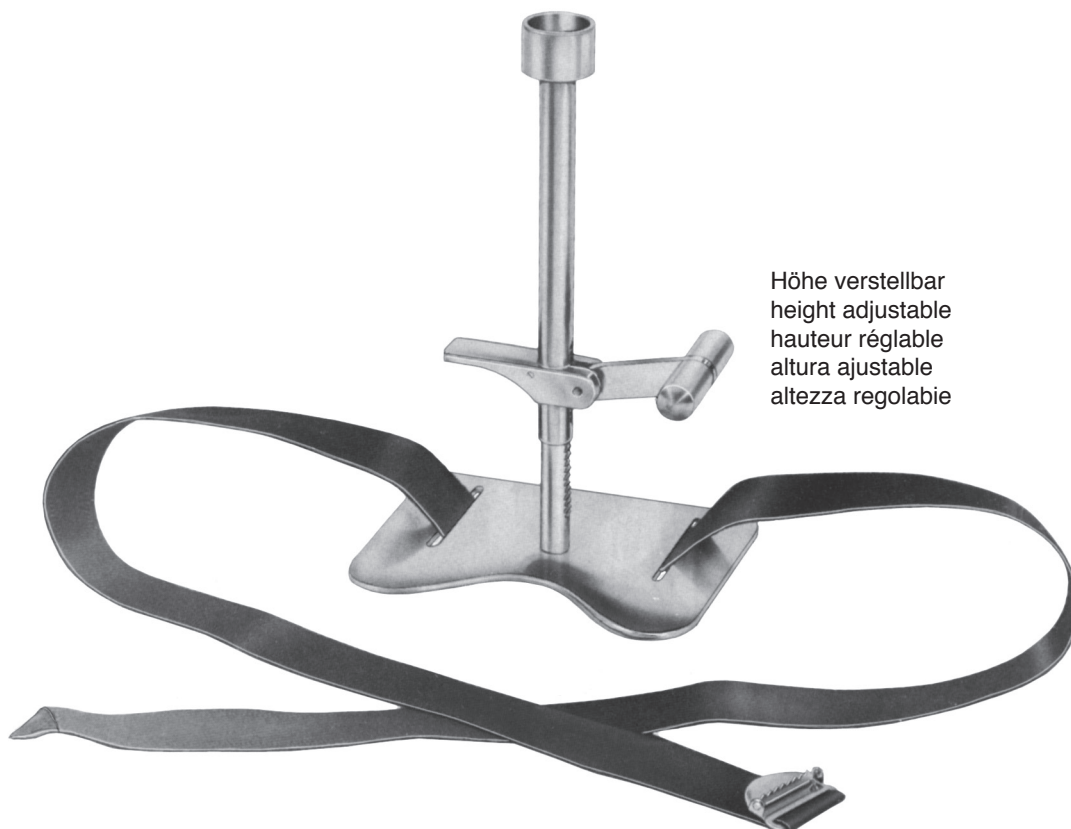

Höhe verstellbar
height adjustable
hauteur réglable
altura ajustable
altezza regolabile

NEGUS
34.0299



COLLIN
11.0100
17 cm



YOUNG
11.0119
Paar
pair
paire
par
paio

YOUNG
11.0110
16 cm

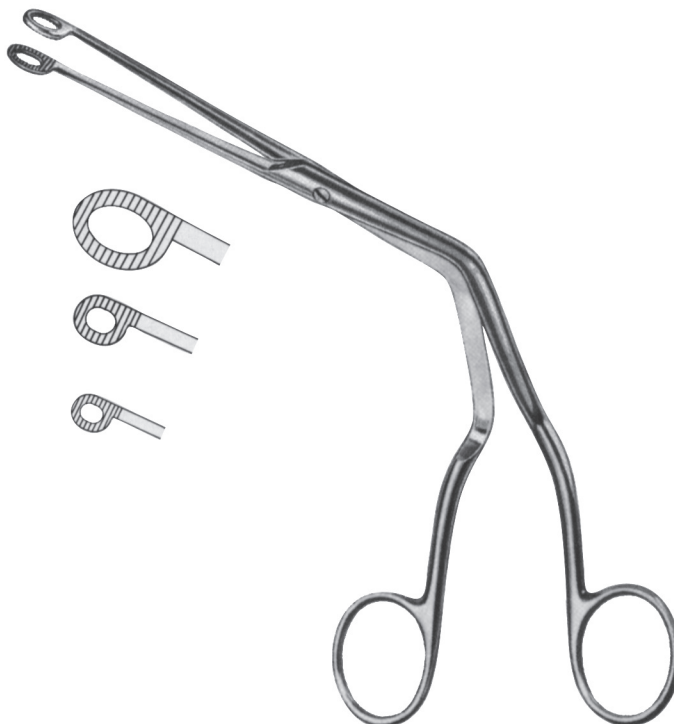

MAGILL
11.0300 24 cm
11.0302 20 cm
11.0304 17 cm



SAWTELL (George)
 34.0301
 19 cm



SCHNIDT
 34.0303
 19 cm

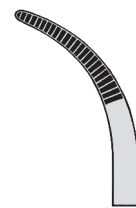

SAWTELL
 34.0305
 19 cm

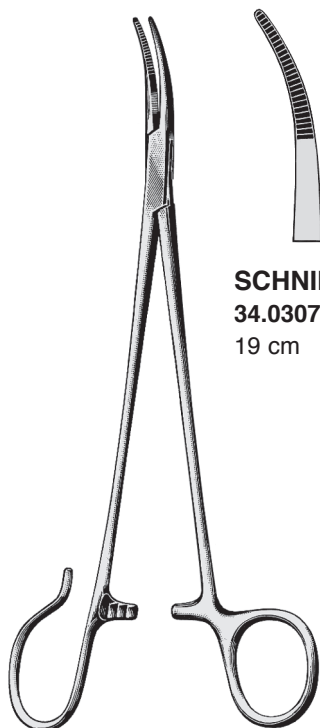

SCHNIDT
 34.0307
 19 cm

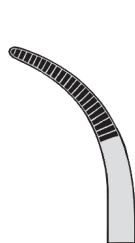

SAWTELL
 34.0309
 19 cm



NEGUS
 19 cm



34.0311



34.0313



WHITE
 34.0321 18 cm
 32.0323 23 cm



COLVER
19 cm



34.0327



34.0329



BIRKETT
18,5 cm



34.0330



34.0331

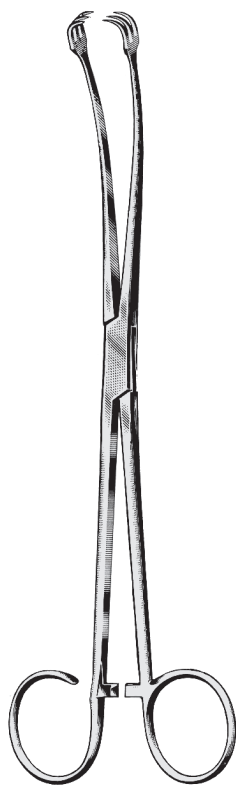

BALLENGER
34.0333
21,5 cm



BLOHMKE
34.0335
20 cm

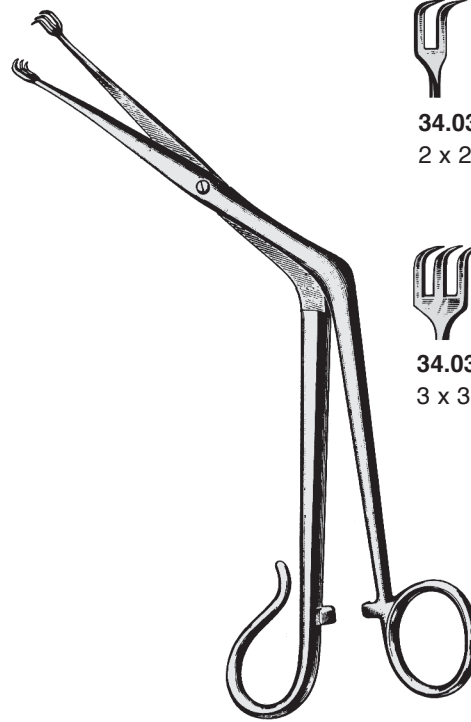

TIVNEN-TYDING
21 cm



34.0342
2 x 2



34.0343
3 x 3

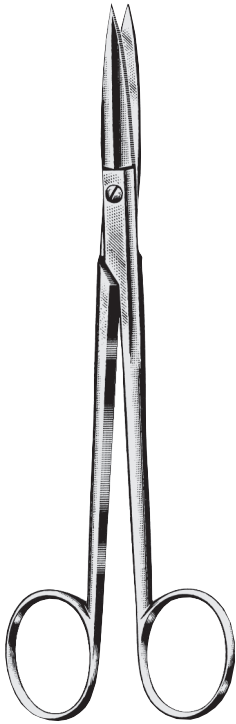

McINDOE
13.2890
 19 cm



DEAN
13.2901 17 cm
 glatt/smooth
 lisse/lisa/liscio
13.2903 17 cm,
 gezahnt/serrated
 dentée/dentada/
 dentate

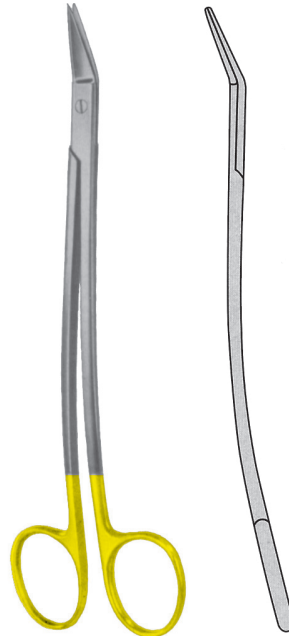

DEAN
13.5901 17 cm
 glatt / smooth / lisse / lisa / liscio
13.5903 17 cm
 gezahnt / serrated / dentelée
 dentada / dentate

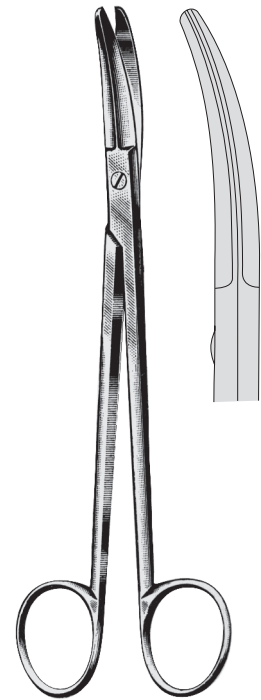

BOETTCHER
13.2925 18 cm

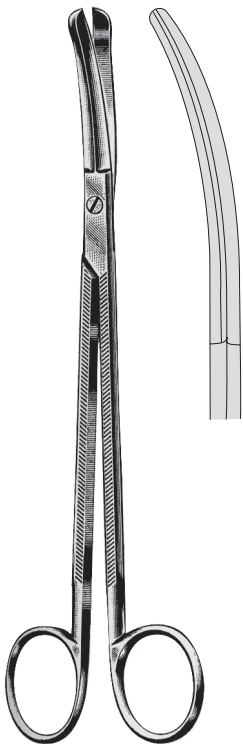

GOOD
13.2930 19 cm
 glatt / smooth / lisse / lisa / liscio
13.2932 19 cm,
 gezahnt / serrated / dentelée
 dentada / dentate

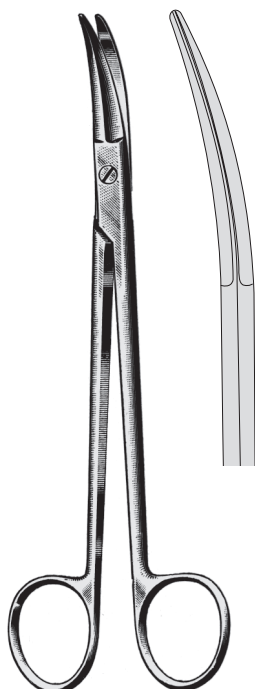

PRINCE
13.2941 17 cm

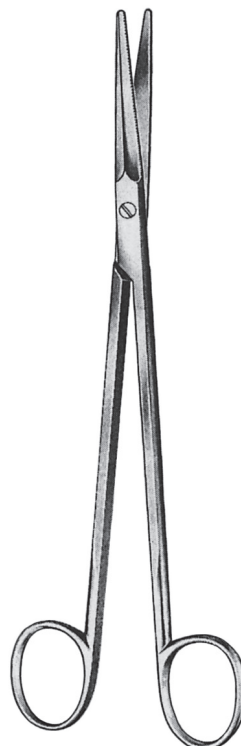

GORNEY



13.3010
 12,5 cm

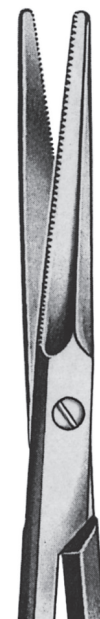

13.3014
 19,0 cm

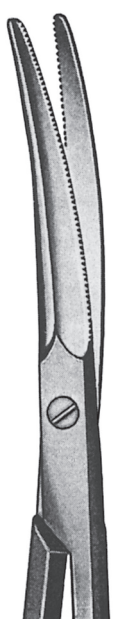

13.3015
 19,0 cm

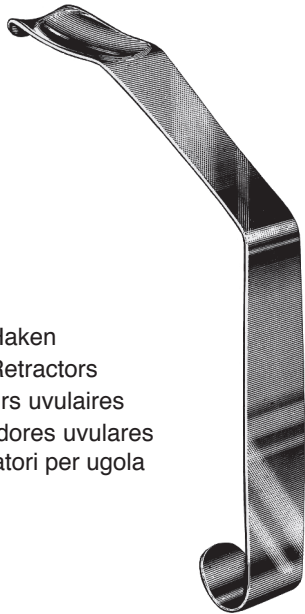

Uvula Haken
 Uvula Retractors
 Ecarteurs uvulaires
 Separadores uvulares
 Divaricatori per ugola

LOVE
 16 cm
34.0370 18 mm
34.0372 20 mm
34.0374 22 mm

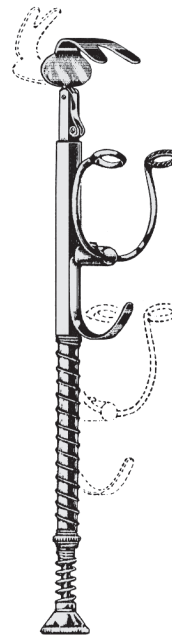

Gaumensegelhalter
 Soft Palate Retractor
 Ecarteur pour voile du palais
 Separador para velo del paladar
 Divaricatore per velo pendulo

HASLINGER
34.0380 16 cm

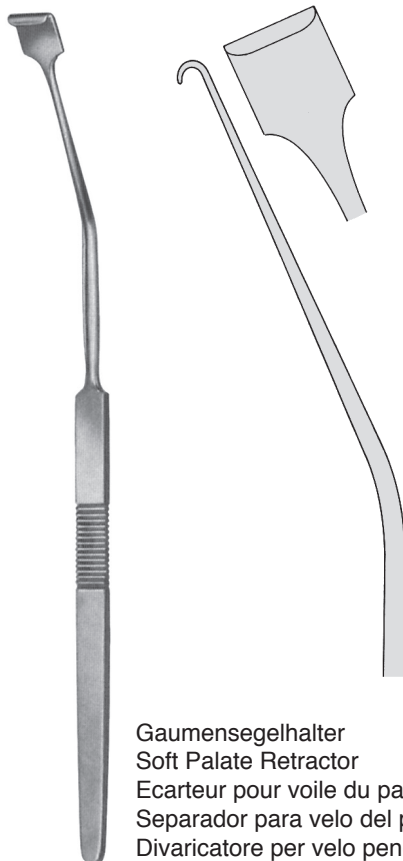

Gaumensegelhalter
 Soft Palate Retractor
 Ecarteur pour voile du palais
 Separador para velo del paladar
 Divaricatore per velo pendulo

NAGER
34.0520 23 cm



Gaumenbogenhaken
 Palate Arch Retractor
 Ecarteur pour voûte palatine
 Separador para arco del paladar
 Divaricatore per velo pendulo

HOFER
34.0530 24 cm

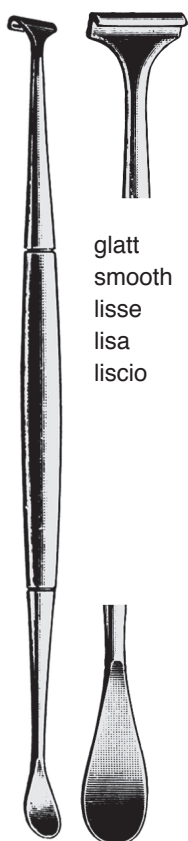

glatt
 smooth
 lisse
 lisa
 liscio

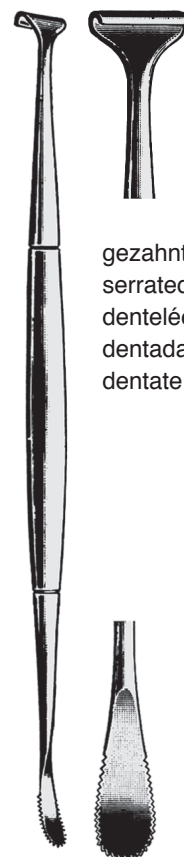

gezahnt
 serrated
 dentelée
 dentada
 dentate

HURD
 34.0500 22,5 cm

HURD
 34.0502 22,5 cm

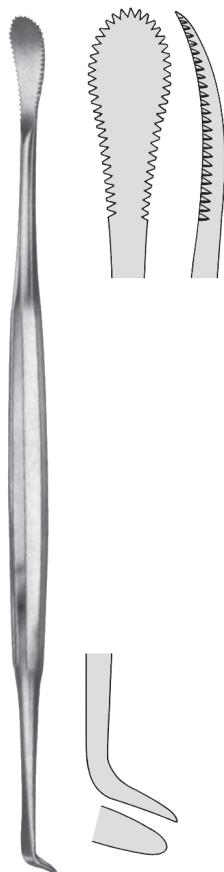

HENKE
 34.0510 23 cm



HENKE
 34.0512 23 cm

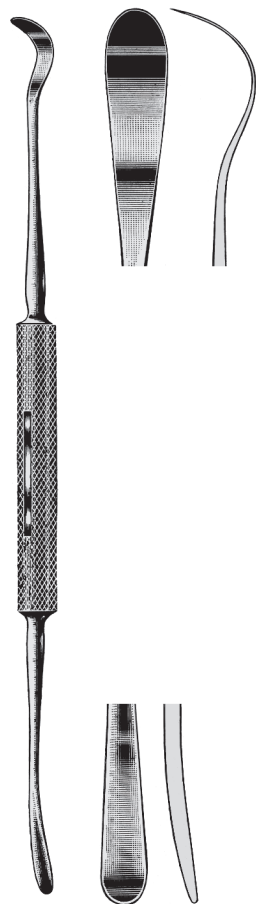

CARPENTER
 34.0516
 24 cm

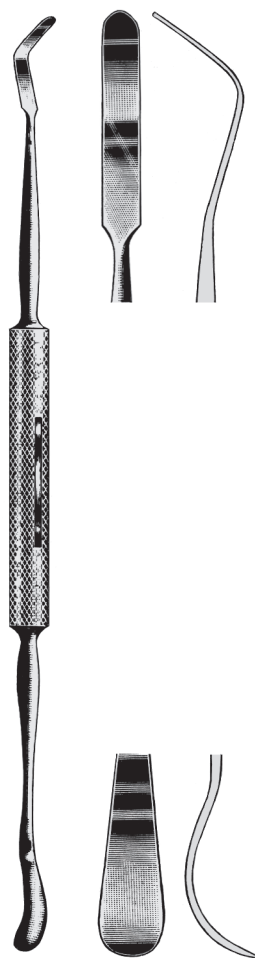

CARPENTER
 34.0517
 25 cm



mit Absaugvorrichtung
 with suction device
 avec aspiration
 con aspiración
 con aspiratore

LOPEZ-REINKE
 34.0504
 23,5 cm

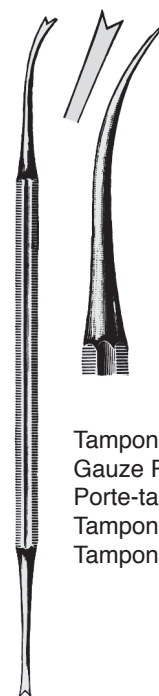

Tamponstopfer
 Gauze Packer
 Porte-tampon
 Tamponeador
 Tamponatore

LUNIATSCHEK
 34.0540
 19 cm

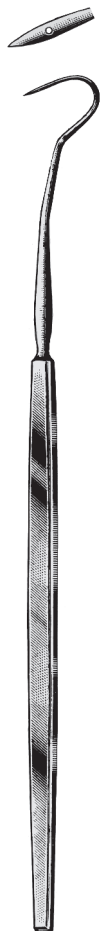

CLAUS-EICKEN
34.0662
 23 cm



NAGER
34.0664
 24 cm

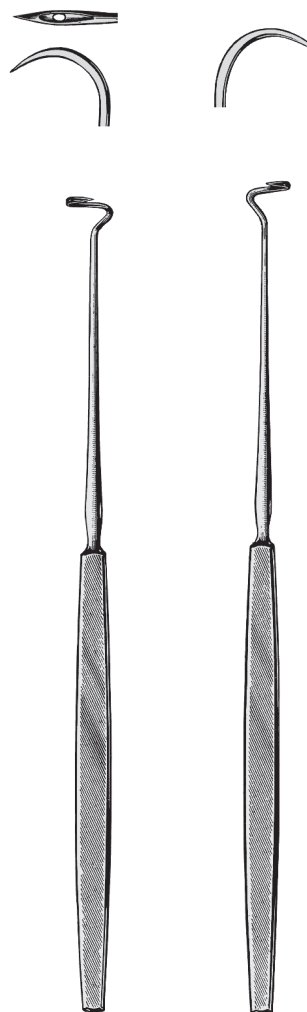

DUPUY-WEISS
 22 cm

34.0670

für die rechte Hand
 for right hand
 pour main droite para
 la mano derecha
 per la mano destra

34.0671

für die linke Hand
 for left hand
 pour main gauche
 para la mano izquierda
 per la mano sinistra

PRO-MED ist Ihnen behilflich bei der Zusammenstellung von Operationsbestecken für die verschiedensten Disziplinen. Fragen Sie nach unseren vorbereiteten OP-Bestecken.

For your convenience a wide variety of Suggested Operating Sets for most general and specialized procedures is available from **PRO-MED**. Please contact us or your local dealer.

PRO-MED vous propose de multiples compositions de boîtes opératoires multidisciplinaires. Demandez nos suggestions pour de nombreuses interventions.

PRO-MED le ayuda en componer varias cajas de instrumentos quirúrgicos. Pregunte por nuestro instrumental quirúrgico preparado.

Per la vostra comodità **PRO-MED** Vi aiuta nella raccolta di strumenti chirurgici per le varie discipline. Vi preghiamo di chiedere informazioni sui nostri set di strumenti chirurgici già preparati.



HURD
21 cm

34.0672

für die rechte Hand
for right hand
pour main droite para
la mano derecha
per la mano destra

34.0673

für die linke Hand
for left hand
pour main gauche
para la mano izquierda
per la mano sinistra

FALK
24 cm

34.0674

für die rechte Hand
for right hand
pour main droite para
la mano derecha
per la mano destra

34.0675

für die linke Hand
for left hand
pour main gauche
para la mano izquierda
per la mano sinistra



ABRAHAM
34.0800 21 cm



FOWLER
34.0806 20 cm

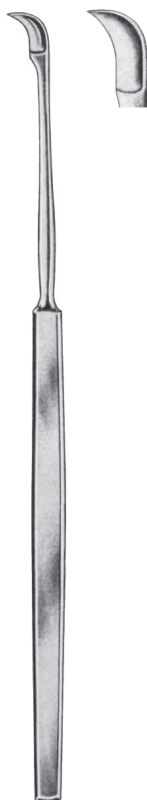

CANFIELD
34.0810 21 cm

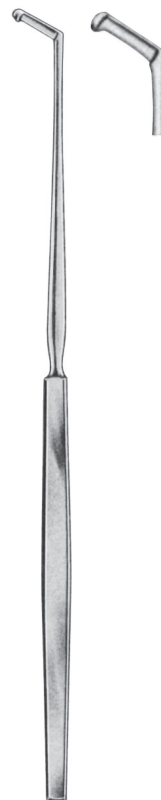

DOUGLAS
34.0820 21 cm



TYDING
34.0825 21 cm



FISHER
34.0830 22 cm



BRUENINGS
34.0850 23 cm



DEAN
34.0860 19 cm

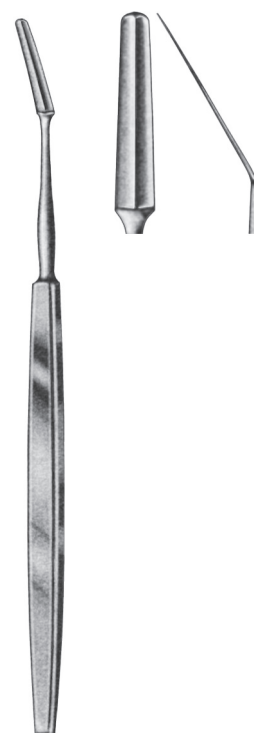

DEAN
34.0861 19 cm

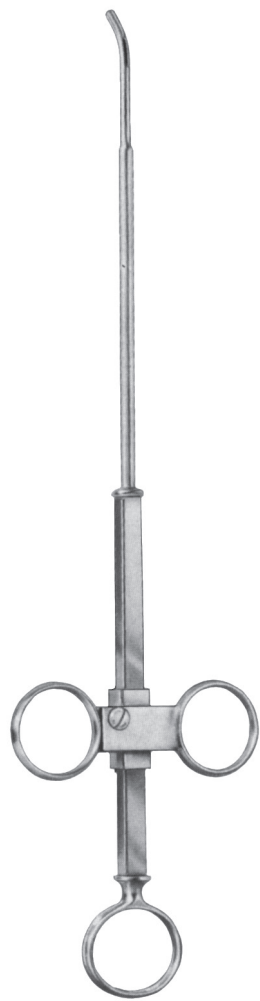

ROEDER
 34.0660
 26,5 cm



EVES
 34.1000
 28 cm



EVES
 34.1005
 28 cm

mit Sperre
 with catch
 avec crémaillère
 con cremallera
 con cremagliera

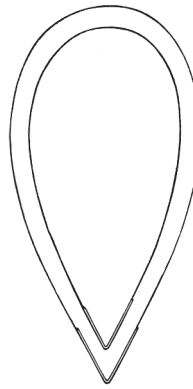

100 Stück
 100 pieces
 100 pieces
 100 piezas
 100 pezzi

34.1007 40 mm
 34.1008 50 mm

12 Stück
 12 pieces
 12 pieces
 12 piezas
 12 pezzi



34.1009 0,3 mm Ø



mit Sperre
 with catch
 avec crémaillère
 con cremallera
 con cremagliera

BRUENINGS
 34.1010
 28 cm

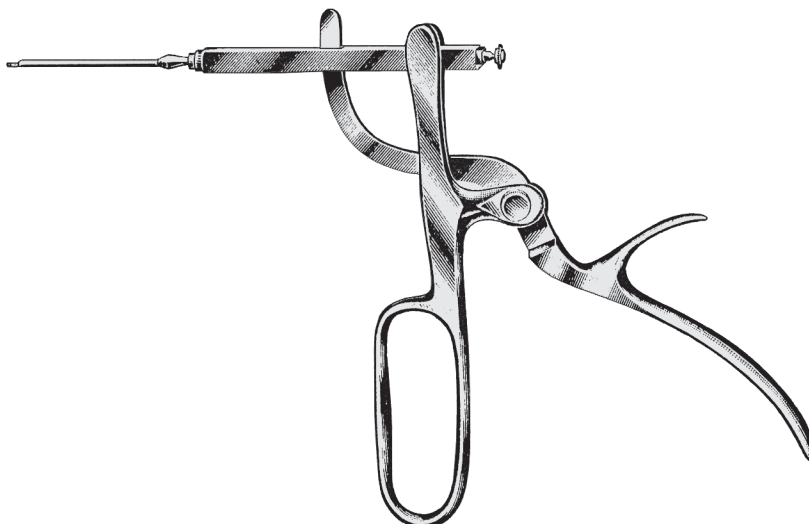

TYDING
 34.1050
 mit geradem Aufsatz
 with straight tip
 avec embout droit
 con guida-asa recto
 con terminale retto

Aufsätze allein
Blades only
Embouts seuls
Puntas sueltas
Lame sole



SLUDER-BALLEGER

34.1113

komplett mit 3 Aufsätzen 34.1115, 34.1116, 34.1117
complete with 3 tips 34.1115, 34.1116, 34.1117
complet avec 3 embouts 34.1115, 34.1116, 34.1117
completo con 3 puntas 34.1115, 34.1116, 34.1117
completo con 3 lame 34.1115, 34.1116, 34.1117

34.1114
Griff allein
Handle only
Manche seul
Mango suelto
Manico solo

Messer alleine
Knives only
Couteaus seul
Cuchillos solo
Coltelli solo 16 mm

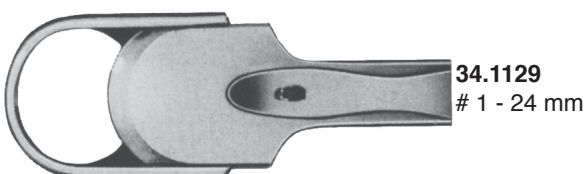
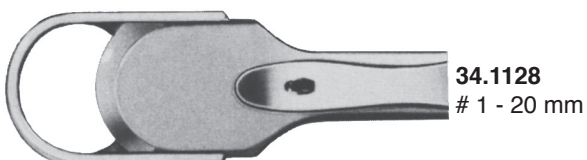
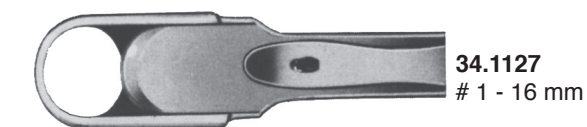

Tonsillotome mit Doppelklinge zum Quetschen und Schneiden
Tonsillotomes with double blade for squeezing and cutting
Amygdalotomes avec lame double pour écraser et couper
Amigdalotómos con hoja doble para magullar y cortar
Tonsillotomi con lama doppio per schiacciare e tagliare



DANIELS

34.1121 16 mm

34.1122 20 mm

34.1123 24 mm

