

WUNDSPEIZER  
RETRACTORS, SELF-RETAINING  
ECARTEURS AUTOSTATIQUES  
SEPARADORES AUTOSTATICOS  
DIVARICATORI AUTOSTATICI

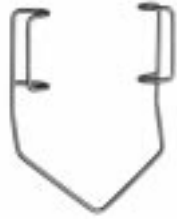



**BARRAQUER**  
**30.0003**  
 30 mm  
 Kinder  
 children  
 enfants  
 niños  
 bambini



**BARRAQUER**  
**30.0004**  
 40 mm  
 Erwachsene  
 adults  
 adultes  
 adultos  
 adulti



**BARRAQUER**  
**30.0005**  
 40 mm



**BOWMAN**  
**30.0007**  
 7 cm



**30.0008**  
 5 cm  
 Öffnung 35 mm  
 opening 35 mm  
 ouverture 35 mm  
 apertura 35 mm  
 apertura 35 mm



**SMITH**  
**30.0010**  
 5 cm



**CRITCHETT**  
**30.0020**  
 6 cm



**CLARKE**  
**30.0030**  
 8 cm



**GRAEFE**  
**30.0040** 6 cm  
**30.0042** 9 cm



**WEISS**  
**30.0050**  
 8 cm



**SAUER**  
**30.0060**  
 6 cm



**ARRUGA**  
**30.0070**  
 7 cm



**ARRUGA**  
**30.0072**  
 7 cm



**MURDOCK**  
**30.0076**  
 5 cm



**MELLINGER-AXENFELD**  
**30.0080**  
 7 cm



**MELLINGER-AXENFELD**  
**30.0082**  
 7 cm



**MELLINGER**  
**30.0084** 5 cm  
 Kinder/children  
 enfants /niños/bambini  
**30.0085** 7 cm  
 Erwachsene/adults  
 adultes/adultos/adulti



**LISTER-BURCH**  
**30.0090**  
 8 cm



**WILLIAMS**  
**30.0094** 7 cm  
**30.0095** 8 cm



**LANCASTER**  
**30.0100**  
 7 cm



**ZIEGLER**  
**30.0110**  
 7 cm



**PLEY**  
**30.0115**  
 6 cm



**CASTROVIEJO**  
**30.0120**  
 8 cm



**PARK**  
**30.0130**  
 8 cm



**PARK-GUYTON**  
**30.0135**  
 8 cm



**PARK-MAUMENEE**  
**30.0136**  
 8 cm



**MUELLER**  
**30.0140**  
 7 cm



**STEVENSON**  
**30.0150**  
 7 cm



**GOLDSTEIN**  
**30.0160**  
3 cm



**GOLDSTEIN-MINI**  
**30.0162**  
3 cm



**AGRICOLA**  
**30.0170**



**COOK**  
**30.0181** 3 cm  
Kinder/children  
enfants /niños/bambini  
**30.0182** 5 cm  
Erwachsene/adults  
adultes/adultos/adulti



**LIEBERMANN**  
**30.0190** 8 cm  
"K"-form/"K"-shaped/  
forme "K"/forma "K"/  
forma "K"



**LIEBERMANN**  
**30.0191** 8 cm  
"V"-form/"v"-shaped/  
forme "V"/forma "V"/  
forma "V"



**LIEBERMANN**  
**30.0192** 8 cm  
Kinder/children/  
enfants /niños/bambini



**LIEBERMANN**  
**30.0193** 8 cm  
Erwachsene/adults/  
adultes/adultos/adulti



**FINSEN**



**17.5000** 5 cm  
 spitz  
 sharp  
 pointu  
 agudo  
 appuntato



**17.5001** 5 cm  
 stumpf  
 blunt  
 mousse  
 romo  
 smusso

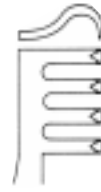

**17.5002** 7 cm  
 spitz  
 sharp  
 pointu  
 agudo  
 appuntato



**17.5003** 7 cm  
 stumpf  
 blunt  
 mousse  
 romo  
 smusso



**FINSEN**



**17.5006** 7 cm  
 spitz  
 sharp  
 pointu  
 agudo  
 appuntato



**17.5007** 7 cm  
 stumpf  
 blunt  
 mousse  
 romo  
 smusso



**WUNDSPREIZER**

**17.5008** 8 cm  
**17.5009** 11 cm



**BOSE**

**36.0120** 7 cm  
 Tracheal-Wundspreizer/  
 Trachea Retractor/  
 Ecarteur trachéal/  
 Retractor traqueal/  
 Divaricatore tracheale



**ALM**



spitz  
 sharp  
 pointu  
 agudo  
 appuntato  
**17.5010** 7 cm



stumpf  
 blunt  
 mousse  
 romo  
 smusso  
**17.5011** 7 cm

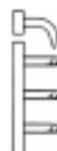

spitz  
 sharp  
 pointu  
 agudo  
 appuntato  
**17.5012** 10 cm

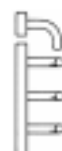

stumpf  
 blunt  
 mousse  
 romo  
 smusso  
**17.5013** 10 cm



**ALM**  
**17.5015**  
 7 cm / 5,5 mm  
 stumpf  
 blunt  
 mousse  
 romo  
 smusso



**ALM**  
**17.5017**  
 7 cm / 16 mm  
 stumpf  
 blunt  
 mousse  
 romo  
 smusso



**ALM**  
**17.5019**  
 10 cm / 15 mm



**HOLTZHEIMER**  
**17.5020** 10 cm  
 scharf/sharp/pointu/  
 agudo/appuntato  
**17.5021** 10 cm  
 stumpf/blunt/mousse/  
 romo/smusso



**EPICARDIAL**

**17.5030** 0,6N  
**17.5031** 1,2N  
**17.5032** 1,8N

Epicardial Spreizer, 4 cm, stumpf, 8x11 mm,  
 25 mm Spreizweite, Gewicht 1 gr., TITAN

Epicardial Spreader 4 cm, blunt, 8x11 mm,  
 spread 25 mm, weight 1 gr., TITANIUM

Epicardial Ecarteur, 4 cm, mousse, 8x11 mm,  
 ouverture 25 mm, poids 1 gr., TITANE

Epicardial Separadore, 4 cm, romo, 8x11 mm,  
 apertura 25 mm, peso 1 gr., TITANIO

Epicardial DIVARICATORE, 4 cm, smusso, 8x11 mm,  
 apertura 25 mm, peso 1 gr., TITANIO



**JANSEN**



**17.5100** 10.5 cm  
 spitz  
 sharp  
 pointu  
 agudo  
 appuntato



**17.5101** 10.5 cm  
 stumpf  
 blunt  
 mousse  
 romo  
 smusso



**ALLPORT**  
**17.5150** 10 cm

geriefte Valven  
 Serrated blades  
 valves striées  
 valvas estriadas  
 Valva con striatura

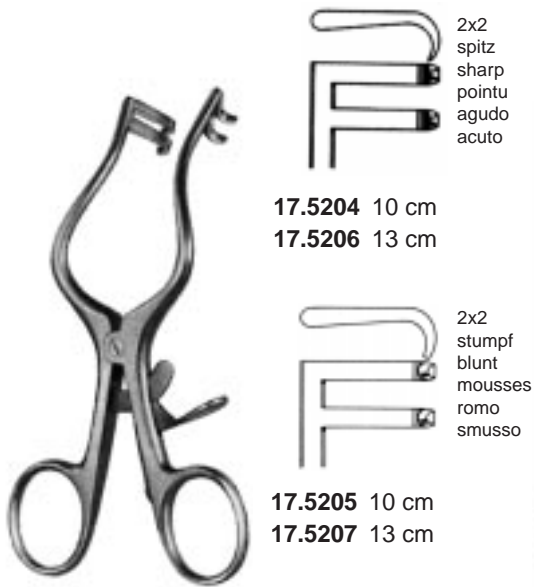

17.5204 10 cm  
 17.5206 13 cm

17.5205 10 cm  
 17.5207 13 cm

**PLESTER**



**COX**  
 17.5210  
 12 cm

für Finger und Zehen  
 Finger- and Toe Retractor  
 pour doigts et orteils  
 para dedos  
 per dita e piede

**SCALP-CONTOUR**  
 14 cm

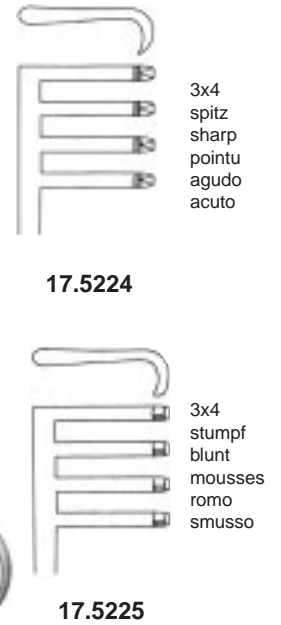

17.5224

17.5225

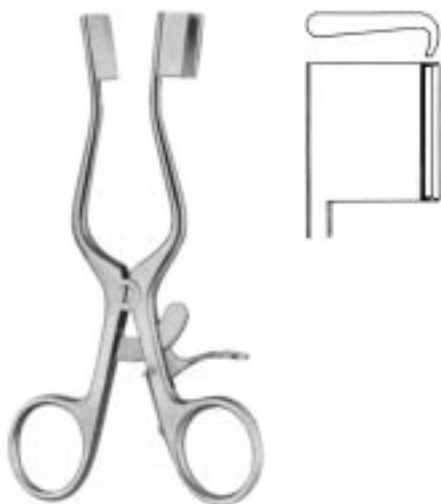

**WEITLANER-BABY**  
 17.5290 14 cm



**WEITLANER**  
 10,5 cm

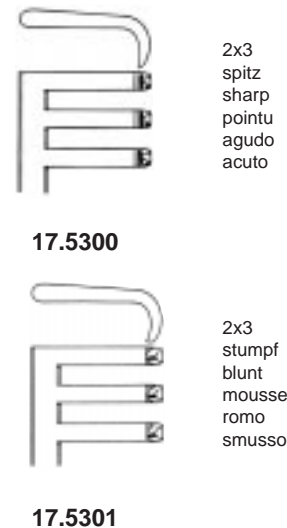

17.5300

17.5301



**WEITLANER**



spitz  
sharp  
pointu  
agudo  
acuto

17.5302 14 cm  
17.5304 16,5 cm



stumpf  
blunt  
mousses  
romo  
smusso

17.5303 14 cm  
17.5305 16,5 cm



**WEITLANER**



spitz  
sharp  
pointu  
agudo  
acuto

17.5306 20 cm

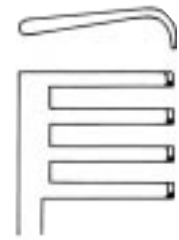

stumpf  
blunt  
mousses  
romo  
smusso

17.5307 20 cm



**WEITLANER**  
24 cm

17.5308 3x4 spitz/sharp/pointu/agudo/acuto 5x6 17.5310  
17.5309 3x4 stumpf/blunt/mousse/romo/smusso 5x6 17.5311



**ADSON**  
19 cm

17.5320 4x4 spitz/sharp/pointu/agudo/acuto  
17.5321 4x4 stumpf/blunt/mousse/romo/smusso





**ADSON**  
 26,5 cm

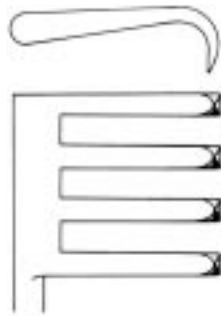

3x4  
 spitz  
 sharp  
 pointu  
 agudo  
 acuto

17.5322

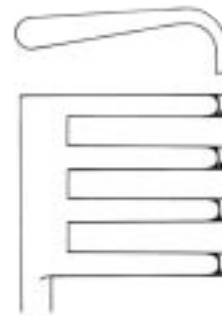

3x4  
 stumpf  
 blunt  
 mousses  
 romo  
 smusso

17.5323

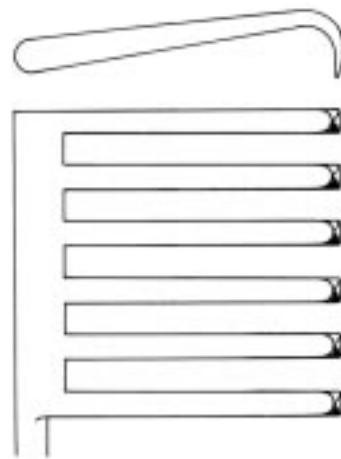

6x6  
 spitz  
 sharp  
 pointu  
 agudo  
 acuto

17.5324

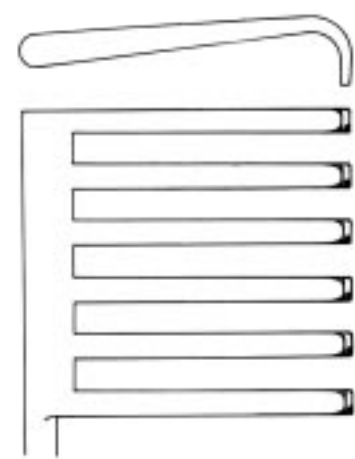

6x6  
 stumpf  
 blunt  
 mousses  
 romo  
 smusso

17.5325



**17.5330**  
 spitz/sharp/pointu/agudo/acuto

**17.5331**  
 stumpf/blunt/mousse/romo/smusso

**ANDERSON-ADSON**  
 20 cm



**HEMILAMINEKTOMIE**  
28 cm

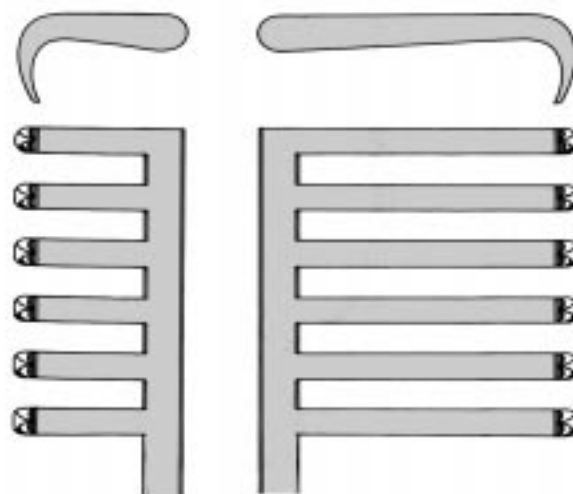

**17.5328**

spitz, lange Zähne links  
sharp, long teeth on right side  
pointu, griffes longues à droite  
agudo, dientes largos a la derecha  
acuto, denti lunghi a sinistra

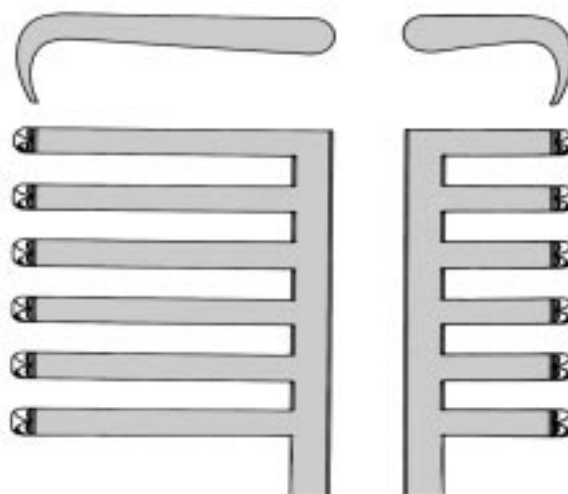

**17.5329**

32x14 mm  
spitz, lange Zähne links  
sharp, long teeth on left  
pointu, griffes longues à gauche  
agudo, dientes largos a la izquierda  
acuto, denti lunghi a destra



**CONE**

25 cm

**17.5332**

spitz/sharp/pointu/agudo/acuto

**17.5333**

stumpf/blunt/mousse/romo/smusso



**TRAVERS**

20cm

**17.5336**

4x5 stumpf/blunt/mousse/romo/smusso



**NORFOLK-NORWICH**

**17.5340**

20 cm



**WALTON**  
 17.5350 18 cm



**WALTON**  
 17.5351 18 cm



**WULLSTEIN**



spitz  
 sharp  
 pointu  
 agudo  
 acuto

17.5400 10,5 cm  
 17.5402 13,0 cm  
 17.5404 16,0 cm



stumpf  
 blunt  
 mousses  
 romo  
 smusso

17.5401 10,5 cm  
 17.5403 13,0 cm  
 17.5405 16,0 cm



**MOLLISON**  
 17.5406  
 15 cm



**MILLIGAN**  
 17.5410  
 13 cm





**SCHUKNECHT**  
17.5416  
13 cm



**PLESTER-R**  
17.5450  
10,5 cm



**PLESTER-L**  
17.5451  
10,5 cm



**PERKINS-R**  
17.5446  
13 cm



**PERKINS-L**  
17.5447  
13 cm

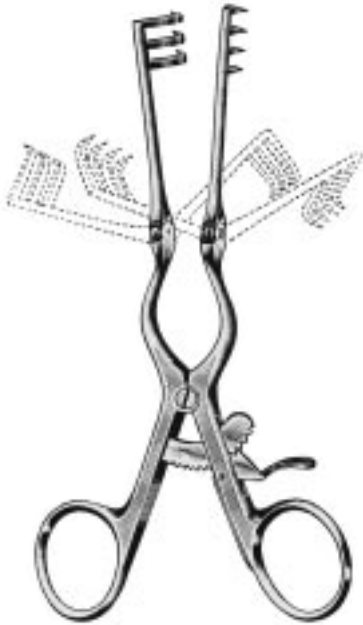

**ADSON-BABY**  
 16 cm

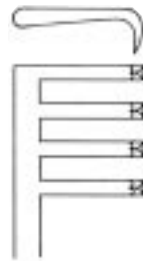

17.5612

3x4  
 spitz  
 sharp  
 pointu  
 agudo  
 acuto



17.5613

3x4  
 stumpf  
 blunt  
 mouses  
 romo  
 smusso



**CLOWARD-CONTOUR**

**17.5460** 13,5 cm

1x1 spitz / sharp / pointu / agudo / acuto

**17.5461** 13,5 cm

1x1 stumpf / blunt / mousse / romo / smusso



**CLOWARD-CONTOUR**

**17.5462** 13,5 cm

3x3 spitz / sharp / pointu / agudo / acuto

**17.5463** 13,5 cm

3x3 stumpf / blunt / mousse / romo / smusso



**CHARNLEY**  
**17.5590**  
28 cm  
Horizontalspreizer  
Horizontal Spreader  
Ecarteur horizontal  
Separador horizontal  
Divaricatore orizzontale



**SEXTON**  
**17.5596**  
31 cm

spitz  
 sharp  
 pointu  
 agudo  
 acuto

stumpf  
 blunt  
 mousses  
 romo  
 smusso



**17.5600**  
 14 cm

**17.5601**  
 14 cm



**17.5602**  
 16,5 cm

**17.5603**  
 16,5 cm



**17.5604**  
 20 cm

**17.5605**  
 20 cm

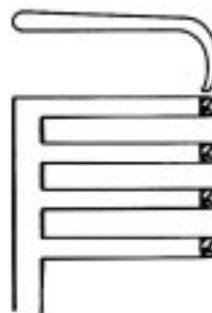
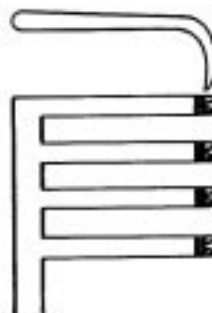

**17.5606**  
 26 cm

**17.5607**  
 26 cm



**BECKMANN-WEITLANER  
 (ADSON, CONE)**



spitz  
sharp  
pointu  
agudo  
acuto

7x7  
spitz  
sharp  
pointu  
agudo  
acuto



**BECKMANN**  
17.5610 31 cm



**BECKMANN-EATON**  
17.5620 32 cm

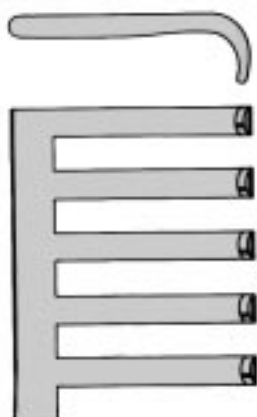

4x5  
 stumpf  
 blunt  
 mousses  
 romo  
 smusso



spitz  
 sharp  
 pointu  
 agudo  
 acuto

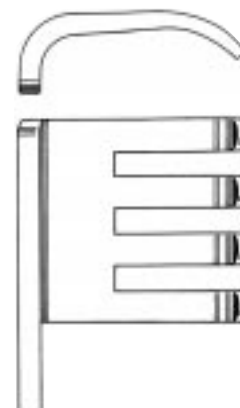

stumpf  
 blunt  
 mousses  
 romo  
 smusso

17.5635 25 mm

17.5636 25 mm



**ADSON**  
 17.5632 32 cm



**BECKMANN-ADSON**  
 31 cm

spitz  
 sharp  
 pointu  
 agudo  
 acuto

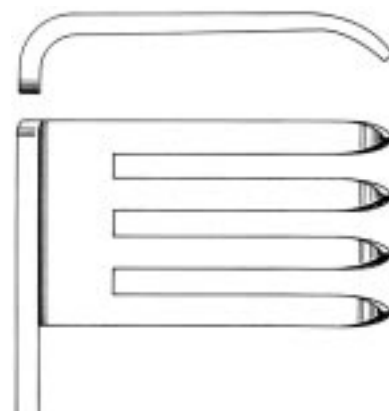

17.5637 44 mm

stumpf  
 blunt  
 mousses  
 romo  
 smusso

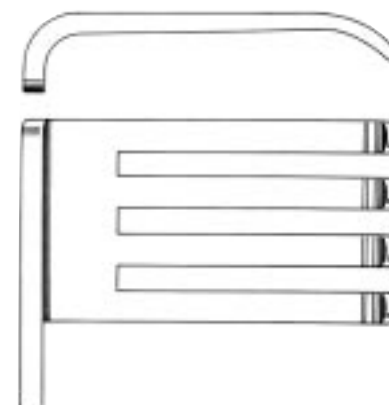

17.5638 44 mm

spitz  
sharp  
pointu  
agudo  
acuto

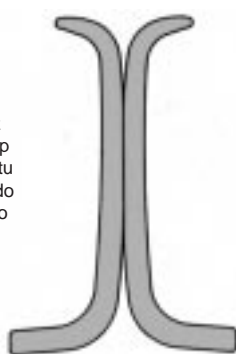

**HARVEY-JACKSON**  
17.5640  
28 cm

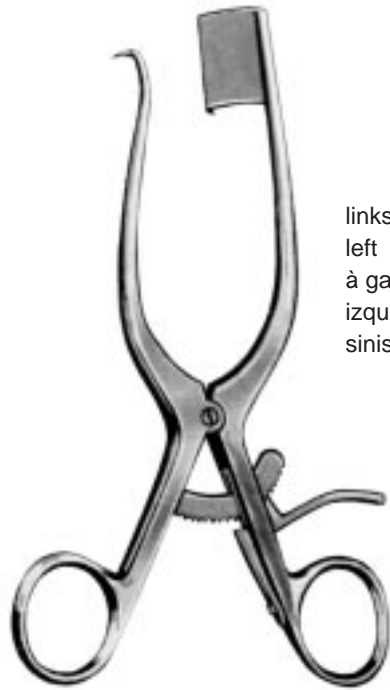

links  
left  
à gauche  
izquierda  
sinistra

**MARKHAM-MEYERDING**  
17.5660 18 cm

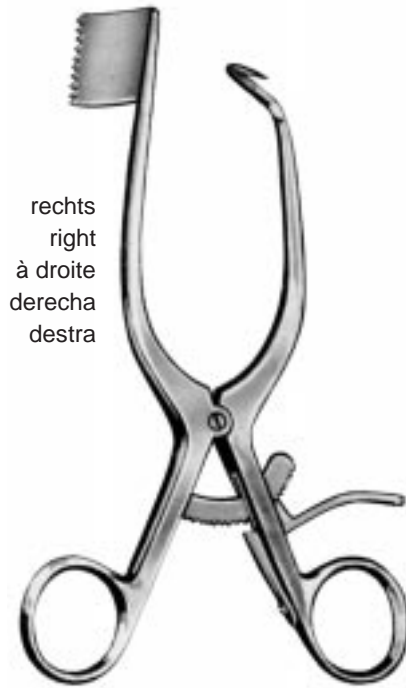

rechts  
right  
à droite  
derecha  
destra

**MARKHAM-MEYERDING**  
17.5662 18 cm



**MEYERDING**  
20 cm

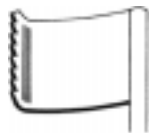

17.5665 32 x 25 mm



17.5666 54 x 25 mm



17.5667 60 x 19 mm



17.5668 60 x 25 mm

76x40 64x25 mm



**DARLING**  
17.5670 18 cm

64x25 76x40 mm



**DARLING**  
17.5672 18 cm



**DEBAKEY-FEMUR**  
17.5890  
10 cm



**DEBAKEY-FEMUR**  
17.5892  
14,5 cm



**JOLL (FRIEDMANN)**  
55.0500  
10 cm



**GELPI-MINI**  
17.5899 10 cm



**GELPI-BABY**  
17.5900 14 cm



**GELPI**  
18 cm  
17.5901 spitz / sharp / pointu / agudo / acuto  
17.5902 stumpf / blunt / mousse / romo / smusso



**GELPI**  
17.5905 18 cm



**GELPI-SELETZ**  
17.5907 15 cm



**JACKSON-BURROWS**  
17.5908 18,5 cm



**GELPI-ORTHO**  
17.5906  
30 cm



**MORRIS-MITRAL**  
40.3400  
16 cm

Gefäßwundspreizer  
Vascular Retractor  
Ecarteur vasculaire  
Separador vascular  
Divaricatore vascolar



**TUEBINGEN**  
 17.5910 16,5 cm



**RIGBY**  
 17.5930 18 cm  
 60 x 20 mm



**RIGBY**  
 17.5932 18 cm  
 35 x 20 mm



**HENLEY**  
 16,5 cm  
 mit Mittelvalven  
 with center blades  
 avec valves centrales  
 con valvas centrales  
 con valve centrale



17.5980



17.5982

17.5985 - 17.5987  
 17.5985 - 17.5987  
 17.5985 - 17.5987  
 17.5985 - 17.5987  
 17.5985 - 17.5987



17.5985  
 16 x 20 mm



17.5986  
 16 x 25 mm



17.5987  
 16 x 30 mm



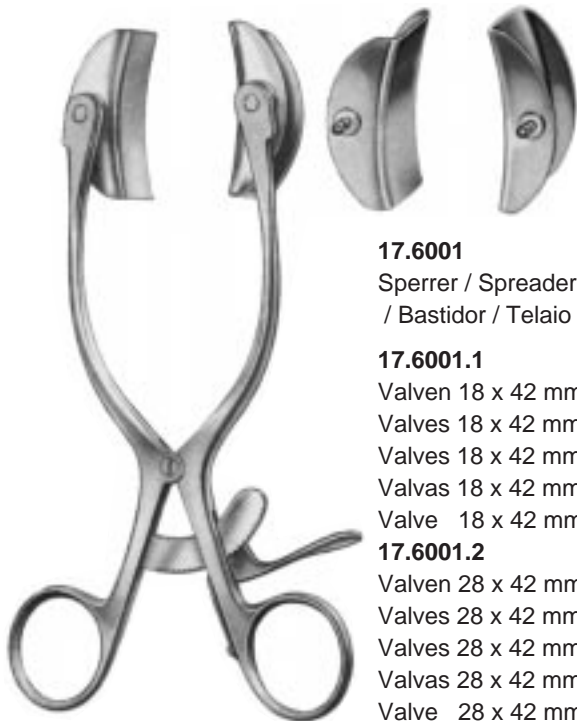

**17.6001**  
 Sperrer / Spreader / Cadre  
 / Bastidor / Telaio

**17.6001.1**  
 Valven 18 x 42 mm (Paar)  
 Valves 18 x 42 mm (Pair)  
 Valves 18 x 42 mm (Paire)  
 Valvas 18 x 42 mm (Par)  
 Valve 18 x 42 mm (Paio)

**17.6001.2**  
 Valven 28 x 42 mm (Paar)  
 Valves 28 x 42 mm (Pair)  
 Valves 28 x 42 mm (Paire)  
 Valvas 28 x 42 mm (Par)  
 Valve 28 x 42 mm (Paio)

## COLLIN-BABY

**17.6000** 18 cm

bestehend aus:

- 17.6001 Rahmen
- 17.6001.1 1 Paar Valven 18x42 mm
- 17.6001.2 1 Paar Valven 28x42 mm

consisting of:

- 17.6001 Frame
- 17.6001.1 Blades 18x42 mm (Pair)
- 17.6001.2 Blades 28x42 mm (Pair)

comprenant:

- 17.6001 cadre seul
- 17.6001.1 valves 18x42 mm (paire)
- 17.6001.2 valves 28x42 mm (paire)

compuesto de:

- 17.6001 bastidor suelto
- 17.6001.1 valvas 18x42 mm (par)
- 17.6001.1 valvas 28x42 mm)

composto da:

- 17.6001 Telaio solo
- 17.6001.1 valve 18x42mm (par)
- 17.6001.2 valve 28x42 mm (par)



**COLLIN**  
**17.6002** 22 cm  
 38 x 60 mm

Valven / Lateral blades / valves  
 latÉrales / valvas laterales /  
 valve laterali 38 x 60 mm



**COLLIN**  
 22 cm  
**17.6003**

Seitenvalven / Lateral blades / valves  
 latÉrales / valvas laterales / valve  
 laterali 38 x 60 mm

Mittelvalve / center blade / valve  
 central / valva centrale / valva  
 centrale 38 x 55 mm

**17.6004**  
 Seitenvalven / Lateral blades / valves  
 latÉrales / valvas laterales / valve  
 laterali 38 x 80 mm

Mittelvalve / center blade / valve  
 central / valva centrale / valva  
 centrale 50 x 75 mm



**COLLIN-LOCKTITE**

17.6007 26 cm

60 x 80 mm

Seitenvalven / Lateral blades /  
valves latérales / valvas laterales /  
valve laterali 60 x 80 mm

Mittelvalve / center blade /  
valve central / valva centrale /  
valva centrale 60 x 75 mm

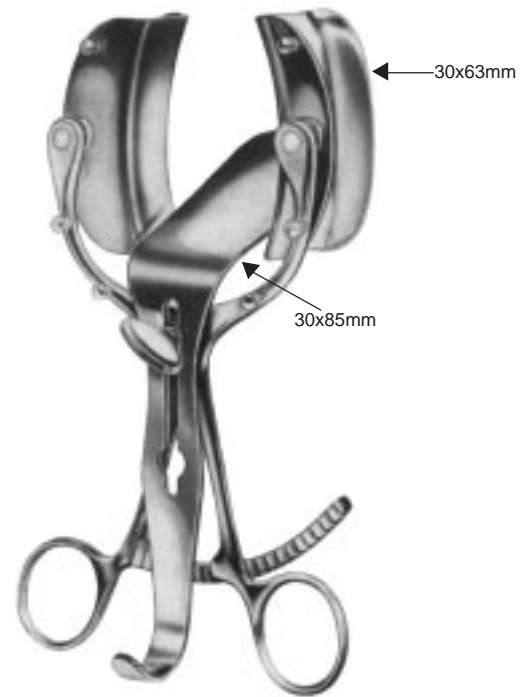

**LEGUEU**

17.6010 18 cm



**MAYO-ADAMS**

17.6015 17 cm



**HOLZBACH**  
**17.6020**



**RICARD**

**17.6030** 28 cm

Mittelvalve 55x70mm, Seitenvlaven 50x58mm  
 Centervalve 55x70, lateral blades 50x58 mm  
 valve centrale 55x70, valves laterales 50x58mm  
 valva central 55x70, valvas laterales 50x58mm  
 valva centrale 55x70, valve laterali 50x58mm

**17.6035** 30 cm

Mittelvalve 80x90mm, Seitenvlaven 60x80mm  
 Centervalve 80x90, lat. blades 60x80 mm  
 valve centrale 80x90, valves laterales 60x80mm  
 valva central 80x90, valvas laterales 60x80mm  
 valva centrale 80x90, valve laterali 60x80mm

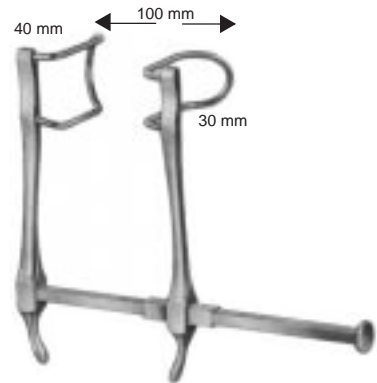

**GOSSET**  
 17.6100 100 mm

**ROBIN-MASSE**

17.6040 21cm

Mittelvalve 40x64mm, Seitenvalven 38x62mm  
 Centervalue 40x64, lat. blades 38x62 mm  
 valve centrale 40x64, valves laterales 38x62mm  
 valva central 40x64, valvas laterales 38x62mm  
 valva centrale 40x64, valve laterali 38x62mm

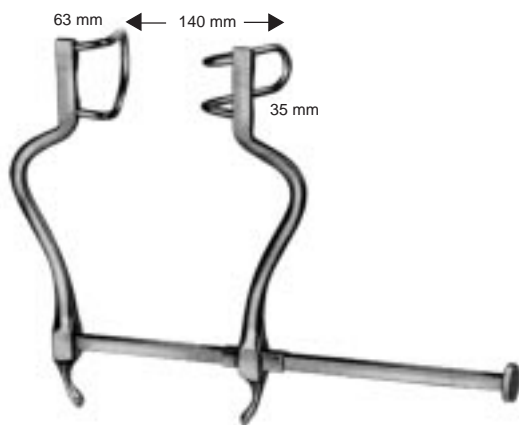

**GOSSET**  
 17.6101 140mm

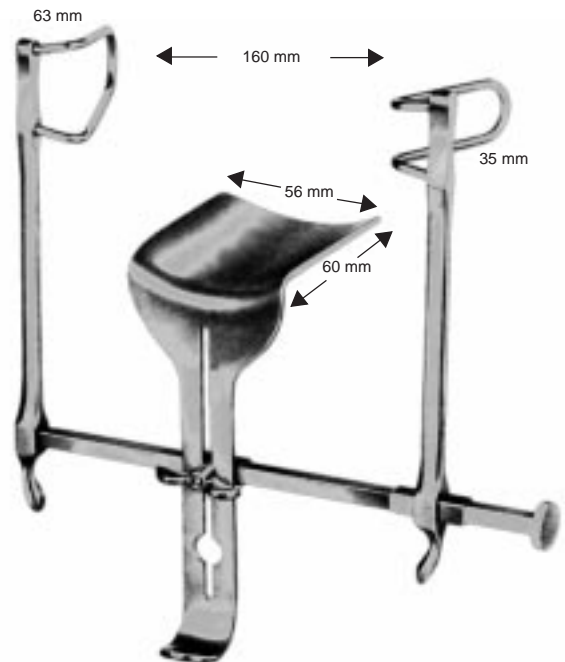

**GOSSET**  
 17.6102 160mm

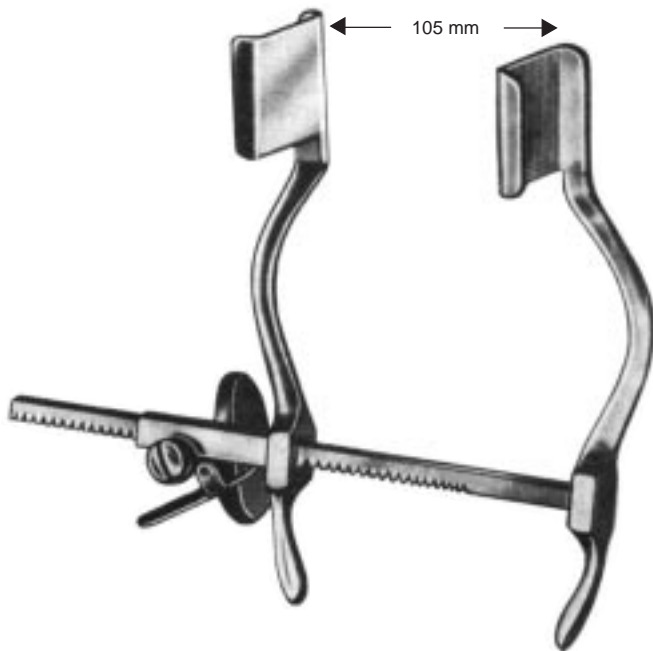

**HERTZLER**  
 17.6110

Spreizweite / spread / écartement / abertura / apertura 105 mm  
 Tiefe, Breite / Depth, Width / profondeur, largeur /  
 profundidad, ancho / profondità, larghezza : 25 x 25 mm



**BALFOUR-BABY**  
 17.6150 90 mm

Spreizweite / spread / écartement / abertura / apertura 90 mm

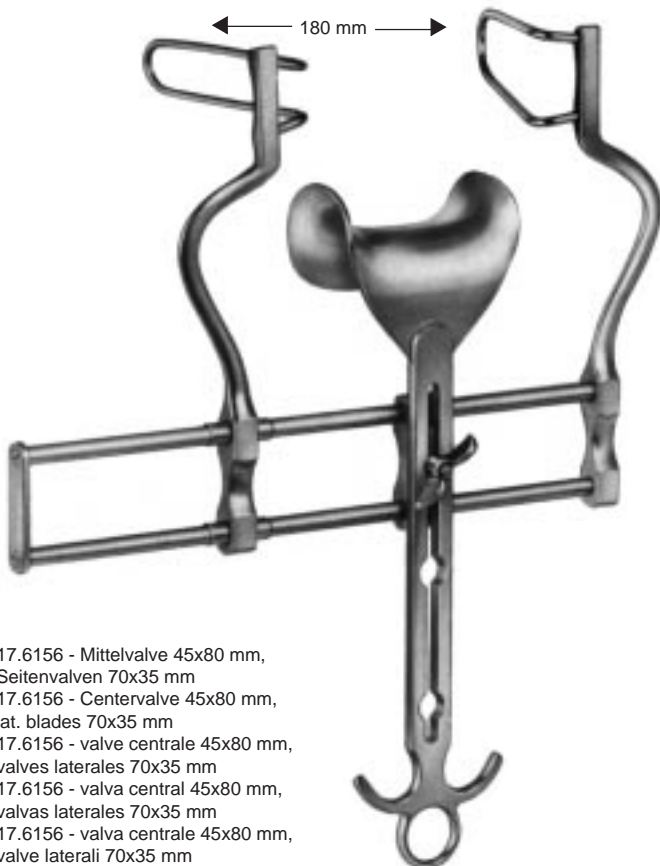

17.6156 - Mittelvalve 45x80 mm,  
 Seitenvälvn 70x35 mm  
 17.6156 - Centervälvn 45x80 mm,  
 lat. blades 70x35 mm  
 17.6156 - valve centrale 45x80 mm,  
 valves laterales 70x35 mm  
 17.6156 - valva central 45x80 mm,  
 valvas laterales 70x35 mm  
 17.6156 - valva centrale 45x80 mm,  
 valve laterali 70x35 mm

**BALFOUR**  
 17.6152 180 mm

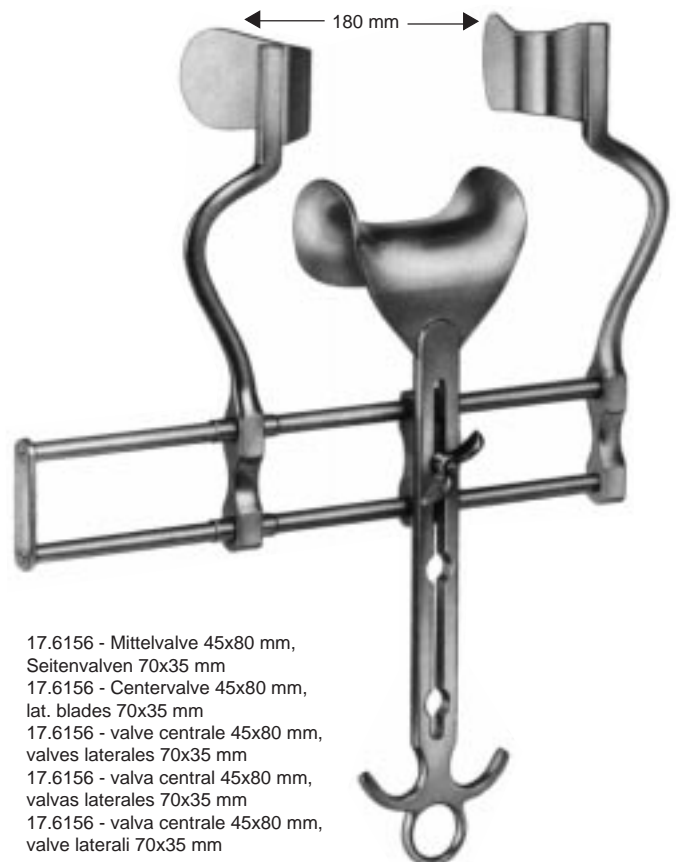

17.6156 - Mittelvalve 45x80 mm,  
 Seitenvälvn 70x35 mm  
 17.6156 - Centervälvn 45x80 mm,  
 lat. blades 70x35 mm  
 17.6156 - valve centrale 45x80 mm,  
 valves laterales 70x35 mm  
 17.6156 - valva central 45x80 mm,  
 valvas laterales 70x35 mm  
 17.6156 - valva centrale 45x80 mm,  
 valve laterali 70x35 mm

**BALFOUR**  
 17.6153 180 mm

- 17.6158 - Mittelvalve 70x85, Seitenvalven 100x35 mm
- 17.6158 - Centervalue 70x85, lateral blades 100x35 mm
- 17.6158 - valve centrale 70x85, valves laterales 100x35 mm
- 17.6158 - valva central 70x85, valvas laterales 100x35 mm
- 17.6158 - valva centrale 70x85, valve laterali 100x35 mm

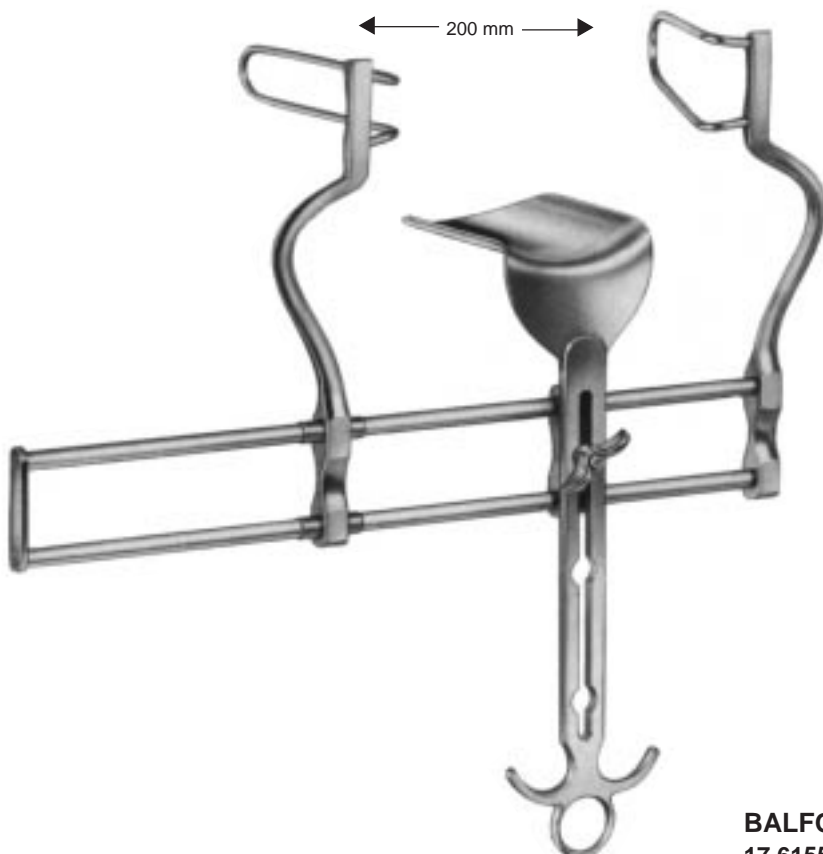
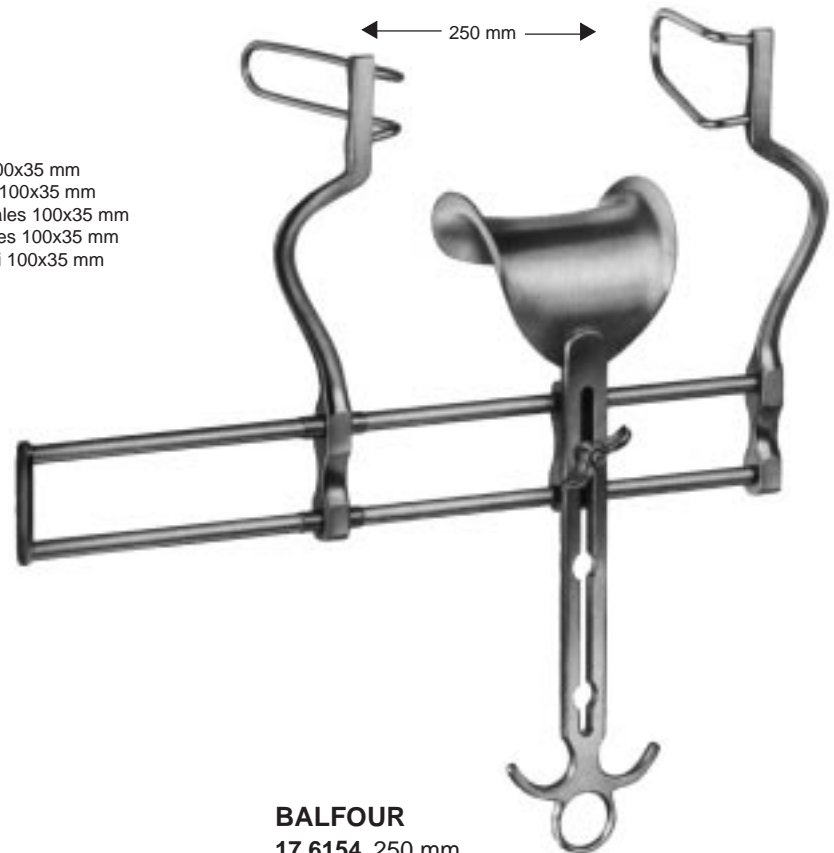

- 17.6157 - Mittelvalve 100x70mm,Seitenvalven 100x35 mm
- 17.6157 - Centervalue 100x70, lateral blades 100x35 mm
- 17.6157 - valve centrale 100x70, valves laterales 100x35 mm
- 17.6157 - valva central 100x70, valvas laterales 100x35 mm
- 17.6157 - valva centrale 100x70, valve laterali 100x35 mm



**17.6174**  
 Paar/Pair  
 Pair/Par  
 Paio 89x45mm

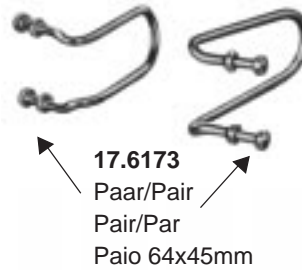

**17.6173**  
 Paar/Pair  
 Pair/Par  
 Paio 64x45mm

**17.6178L**  
 Seitenarm links  
 4th blade attachment left  
 Bras latéral à gauche  
 Brazo lateral izquierdo  
 Braccio lateral sinistra

**17.6178R**  
 Seitenarm rechts  
 4th blade attachment right  
 Bras latéral à droite  
 Brazo lateral derecho  
 Braccio lateral destra



**BALFOUR-Modif.**  
**17.6170** 200 mm  
**17.6172** 265 mm  
 komplett/complete/  
 complet/completo/completo

**BALFOUR**  
**17.6178L**  
**17.6178R**

Mittelvalven für Bauchdeckenhalter  
 Center blades  
 Valves centrales  
 Valvas centrales  
 Valve centrali



**BALFOUR**  
**17.6156** 45 x 80 mm  
**17.6158** 70 x 85 mm  
**17.6159** 80 x 90 mm

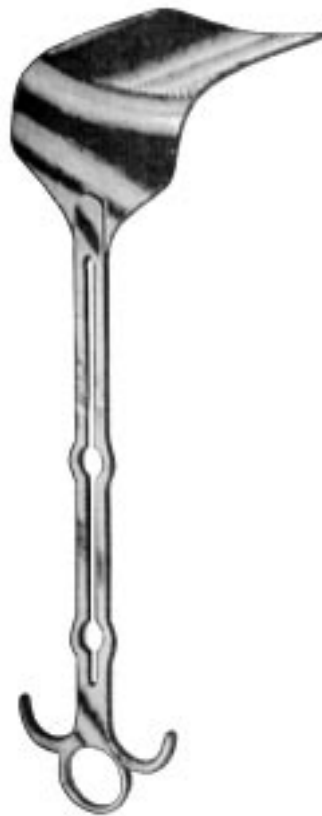

**BALFOUR**  
**17.6157** 100 x 70 mm



**HORGAN**  
**17.6176** 51 x 198 mm



**HORGAN**  
**17.6177** 51 x 127 mm

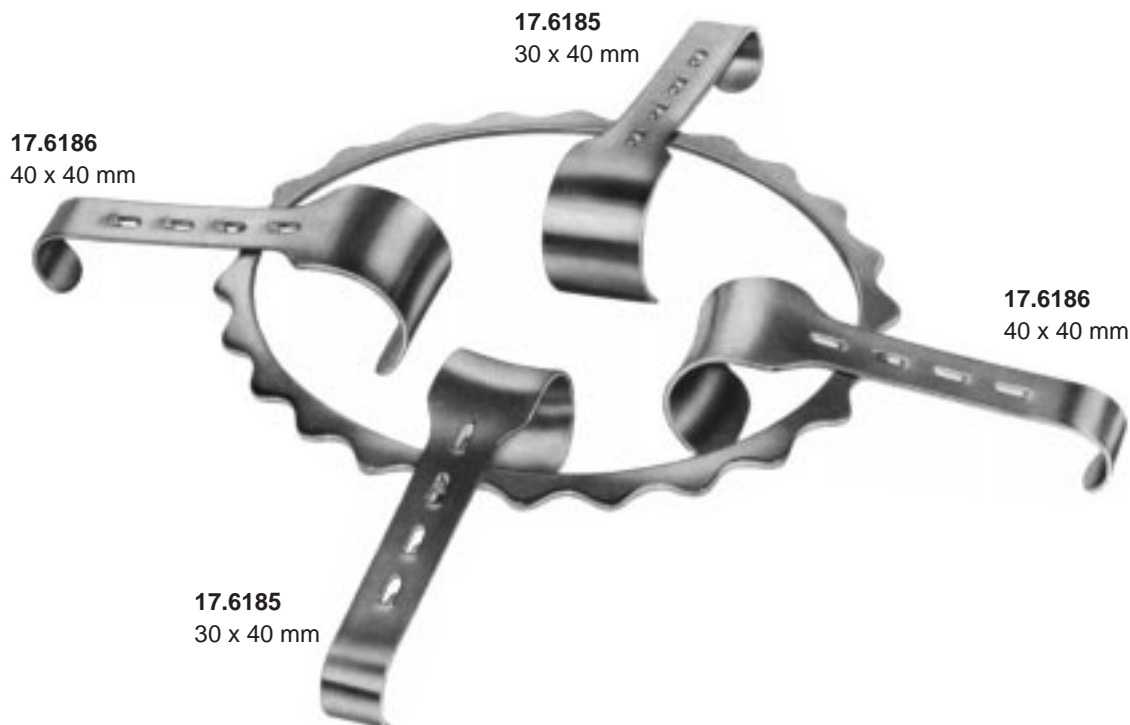

**DENIS-BROWN**

- 17.6180** für Kinder, bestehend aus:  
17.6181 Rahmen 180x150 mm  
17.6185 2 Valven 30x40 mm  
17.6186 2 Valven 40x40 mm  
for children, consisting of:  
17.6181 Frame 180x150 mm  
17.6185 2 valves 30x40 mm  
17.6186 2 valves 40x40 mm  
pour enfants, comprenant:  
17.6181 cadre 180x150 mm  
17.6185 2 valves 30x40 mm  
17.6186 2 valves 40x40 mm  
para niños, compuesto de:  
17.6181 cuadro 180x50 mm  
17.6185 2 valvas 30x40 mm  
17.6186 2 valvas 40x40 mm  
per bambini, composto da:  
17.6181 telaio 180x150 mm  
17.6185 2 valve 30x40 mm  
17.6186 2 valve 40x40 mm

**DENIS-BROWN**

- 17.6182** für Erwachsene, bestehend aus:  
17.6183 Rahmen 255x180 mm  
17.6185 2 Valven 30x40 mm  
17.6186 2 Valven 40x40 mm  
for adults, consisting of:  
17.6183 Frame 255x180 mm  
17.6185 2 valves 30x40 mm  
17.6186 2 valves 40x40 mm  
pour adultes, comprenant:  
17.6183 cadre 255x180 mm  
17.6185 2 valves 30x40 mm  
17.6186 2 valves 40x40 mm  
para adultos, compuesto de:  
17.6183 cuadro 255x180 mm  
17.6185 2 valvas 30x40 mm  
17.6186 2 valvas 40x40 mm  
per adulti, composto da:  
17.6183 telaio 255x180 mm  
17.6185 2 valve 30x40 mm  
17.6186 2 valve 40x40 mm

**DENIS-BROWN**

- 17.6181** Rahmen / frame / cadre / cuadro / telaio 180 x150 mm  
**17.6183** Rahmen / frame / cadre / cuadro / telaio 255 x180 mm



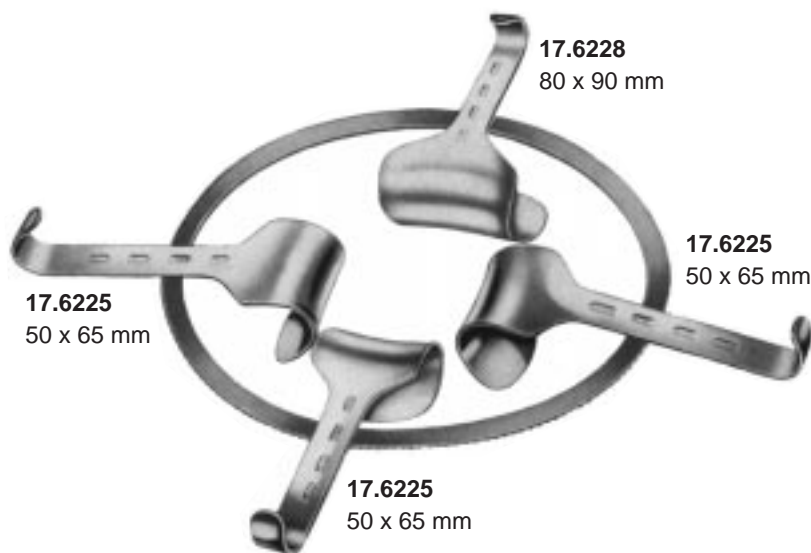

## KIRSCHNER

17.6210

bestehend aus:

- 17.6211 ovaler Rahmen 300x240 mm
- 17.6225 3 Valven 50x65 mm
- 17.6228 1 Valve 80x90 mm
- 17.6229 1 Valve 98x50 mm
- 17.6230 1 Valve 105x35 mm

consisting of:

- 17.6211 oval Frame 300x240 mm
- 17.6225 3 valves 50x65 mm
- 17.6228 1 valve 80x90 mm
- 17.6229 1 valve 98x50 mm
- 17.6230 1 valve 105x35 mm

comprenant:

- 17.6211 cadre oval 300x240 mm
- 17.6225 3 Valves 50x65 mm
- 17.6228 1 Valve 80x90 mm
- 17.6229 1 Valve 98x50 mm
- 17.6230 1 Valve 105x35 mm

compuesto de:

- 17.6211 cuadro oval 300x240 mm
- 17.6225 3 valvas 50x65 mm
- 17.6228 1 valva 80x90 mm
- 17.6229 1 valva 98x50 mm
- 17.6230 1 valva 105x35 mm

composto da:

- 17.6211 telaio oval 300x240 mm
- 17.6225 3 valve 50x65 mm
- 17.6228 1 valva 80x90 mm
- 17.6229 1 valva 98x50 mm
- 17.6230 1 valva 105x35 mm

## KIRSCHNER

17.6211 300x240 mm

Rahmen allein / Frame only / Cadre, seul / Cuadro, solo / Telaio, solo

## KIRSCHNER

17.6220

bestehend aus:

- 17.6222 starrer Rahmen 250x250 mm
- 17.6224 2 Valven 42 x 55 mm
- 17.6225 2 Valven 50 x 65 mm

consisting of:

- 17.6222 rigid frame 250x250 mm
- 17.6224 2 valves 42 x 55 mm
- 17.6225 2 valves 50 x 65 mm

comprenant:

- 17.6222 cadre fixe 250 x 250 mm
- 17.6224 2 valves 42 x 55 mm
- 17.6225 2 valves 50 x 65 mm

compuesto de:

- 17.6222 cuadro fijo 250 x 250 mm
- 17.6224 2 valvas 42 x 55 mm
- 17.6225 2 valvas 50 x 65 mm

composto da:

- 17.6222 telaio fisso 250 x 250 mm
- 17.6224 2 valve 42 x 55 mm
- 17.6225 2 valce 50 x 65 mm

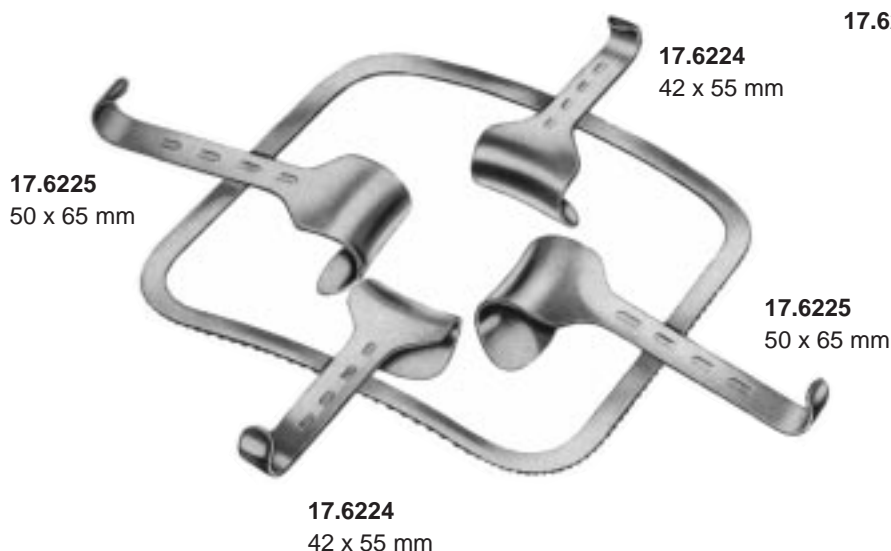

## KIRSCHNER

17.6222 Rahmen allein / Frame only / Cadre, seul / Cuadro, solo / Telaio, solo



### KIRSCHNER

- 17.6221** bestehend aus:  
17.6219 faltbarer Rahmen 250x250 mm  
17.6224 2 Valven 42 x 55 mm  
17.6225 2 Valven 50 x 65 mm  
consisting of:  
17.6219 folding frame 250x250 mm  
17.6224 2 valves 42 x 55 mm  
17.6225 2 valves 50 x 65 mm  
comprenant:  
17.6219 cadre pliant 250 x 250 mm  
17.6224 2 valves 42 x 55 mm  
17.6225 2 valves 50 x 65 mm  
compuesto de:  
17.6219 cuadro plegable 250 x 250 mm  
17.6224 2 valvas 42 x 55 mm  
17.6225 2 valvas 50 x 65 mm  
composto da:  
17.6219 telaio pieghevole 250 x 250 mm  
17.6224 2 valve 42 x 55 mm  
17.6225 2 valce 50 x 65 mm

**17.6219** 250x250 mm  
Rahmen allein / Frame only / Cadre, seul /  
Cuadro, solo / Telaio, solo

### KIRSCHNER

Haken / Blades / Lames / Valvas / Valve



**17.6224**  
42 x 55 mm



**17.6225**  
50 x 65 mm



**17.6226**  
60 x 85 mm



**17.6227**  
78 x 65 mm



**17.6228**  
80 x 90 mm



**17.6229**  
98 x 50 mm



**17.6230**  
105 x 35 mm

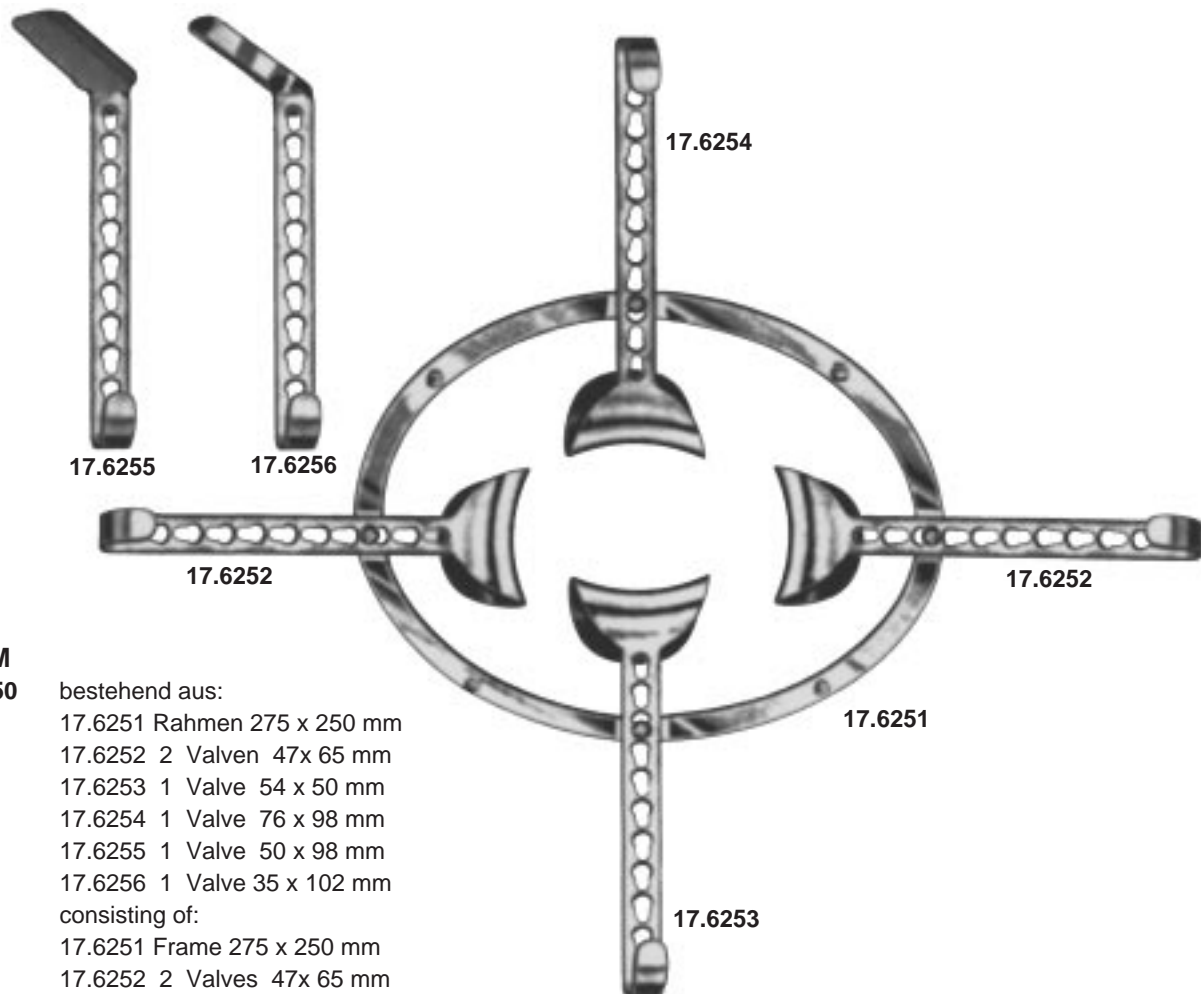

**SEMM**  
**17.6250**

bestehend aus:

- 17.6251 Rahmen 275 x 250 mm
- 17.6252 2 Valven 47x 65 mm
- 17.6253 1 Valve 54 x 50 mm
- 17.6254 1 Valve 76 x 98 mm
- 17.6255 1 Valve 50 x 98 mm
- 17.6256 1 Valve 35 x 102 mm

consisting of:

- 17.6251 Frame 275 x 250 mm
- 17.6252 2 Valves 47x 65 mm
- 17.6253 1 Valve 54 x 50 mm
- 17.6254 1 Valve 76 x 98 mm
- 17.6255 1 Valve 50 x 98 mm
- 17.6256 1 Valve 35 x 102 mm

comprenant:

- 17.6251 Cadre 275 x 250 mm
- 17.6252 2 Valves 47x 65 mm
- 17.6253 1 Valve 54 x 50 mm
- 17.6254 1 Valve 76 x 98 mm
- 17.6255 1 Valve 50 x 98 mm
- 17.6256 1 Valve 35 x 102 mm

compuesto de:

- 17.6251 Cuadro 275 x 250 mm
- 17.6252 2 Valvas 47x 65 mm
- 17.6253 1 Valva 54 x 50 mm
- 17.6254 1 Valva 76 x 98 mm
- 17.6255 1 Valva 50 x 98 mm
- 17.6256 1 Valva 35 x 102 mm

composto da:

- 17.6251 Telaio 275 x 250 mm
- 17.6252 2 Valve 47x 65 mm
- 17.6253 1 Valva 54 x 50 mm
- 17.6254 1 Valva 76 x 98 mm
- 17.6255 1 Valva 50 x 98 mm
- 17.6256 1 Valva 35 x 102 mm

**SEMM**

**17.6251** 275 x 250 mm  
 Rahmen allein / Frame only / Cadre, seul /  
 Cuadro, solo / Telaio, solo

**17.6252** 47 x 65 mm

**17.6253** 54 x 50 mm

**17.6254** 76 x 98 mm

**17.6255** 50 x 98 mm

**17.6256** 35 x 135 mm

Valve / Blades / Lames / Valvas / Valve

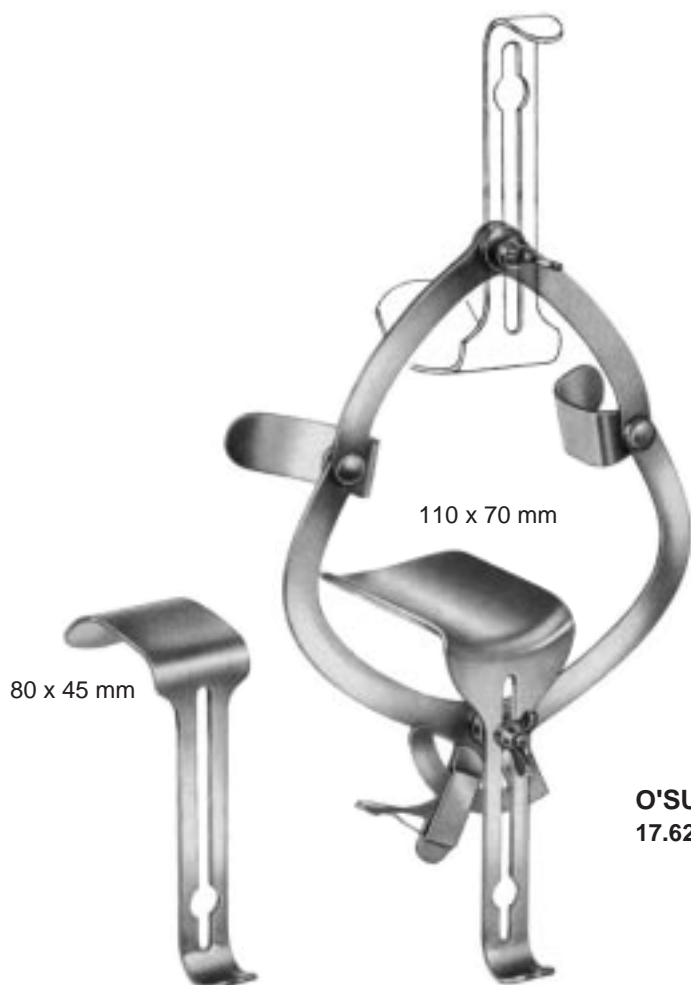

#### O'SULLIVAN-O'CONNOR

17.6260

bestehend aus:

17.6261 Rahmen mit 2 Seitenvalven 62 x 25 mm

17.6262 2 Valven 85 x 45 mm

17.6263 1 Valve 105 x 70 mm

consisting of:

17.6261 Frame with 2 lateral valves 62 x 25 mm

17.6262 2 Valves 85 x 45 mm

17.6263 1 Valve 105 x 70 mm

comprenant:

17.6261 Cadre avec 2 valves latérales 62 x 25 mm

17.6262 2 Valvex 85 x 45 mm

17.6263 1 Valve 105 x 70 mm

compuesto de:

17.6261 Cuadro con 2 valvas laterales 62 x 25 mm

17.6262 2 Valves 85 x 45 mm

17.6263 1 Valva 105 x 70 mm

composta da:

17.6261 Telaio con 2 valve laterali 62 x 25 mm

17.6262 2 Valve 85 x 45 mm

17.6263 1 Valva 105 x 70 mm

17.6261

Rahmen allein / Frame only / Cadre, seul /  
Cuadro, solo / Telaio, solo

17.6262

45 x 85 mm

17.6263

70 x 105 mm

Valve / Blades / Lames / Valvas / Valve



**ROCHARD**  
 17.6277

Rahmen, doppelt  
 Frame, double  
 Cadre, double  
 Quadro doble  
 Telaio doppio

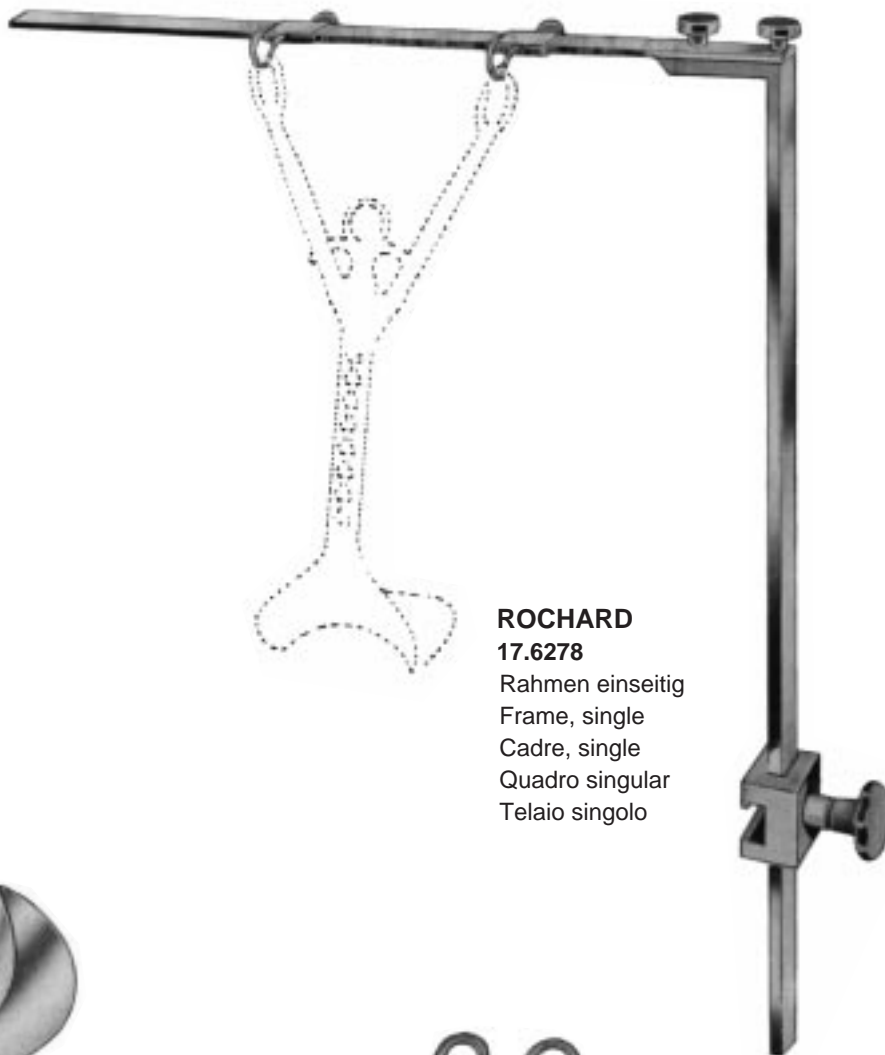

**ROCHARD**  
 17.6278

Rahmen einseitig  
 Frame, single  
 Cadre, single  
 Quadro singular  
 Telaio singolo



**ROCHARD**

17.6270 95 mm  
 17.6271 105 mm  
 17.6272 120 mm  
 17.6273 135 mm  
 17.6274 155 mm



**ROCHARD**  
 17.6279

Fixiervorrichtung  
 Fixation device  
 Compas articulé  
 Dispositivo de fijación  
 Dispositivo di fissaggio



**DOYEN**

**17.6350** 55 x 95 mm

**17.6353** 55 x 105 mm

**17.6354** 55 x 115 mm

**17.6355** 55 x 125 mm



**ABDOMINAL**

**46.0169** 20,5 cm

Spekulum 70 mm / 90°

Abdominal Specula 70 mm / 90°

Spéculum abdominal 70 mm / 90°

espéculo abdominale 70 mm / 90°

Specola abdominale 70 mm / 90°



**17.6309** 8 mm ø

20 Ersatzknöpfe  
20 Spare buttons  
20 Boutons de rechange  
20 Botónes de repuesto  
20 Bottone de ricambio

## FOERSTER

**17.6300** Ø 255 mm

Kunststoff, schwarz, röntgenfähig, komplett mit 4 Valven Nr. 17.6303  
plastic, black, transparent to X-Ray, complete with 4 valves 17.6303  
plastique, noir, transparent aux rayons X, complet avec 4 valves 17.6303  
plástico, negro, transparente a los rayos-X, completo con 4 valvas 17.6303  
plastica, nero, radiotrasparente, completo con 4 valve 17.6303

**17.6301**

Rahmen / frame / Cadre / Cuadro / Telaio Ø 255 mm



**17.6303** 50 x 65 mm



**17.6304** 65 x 75 mm

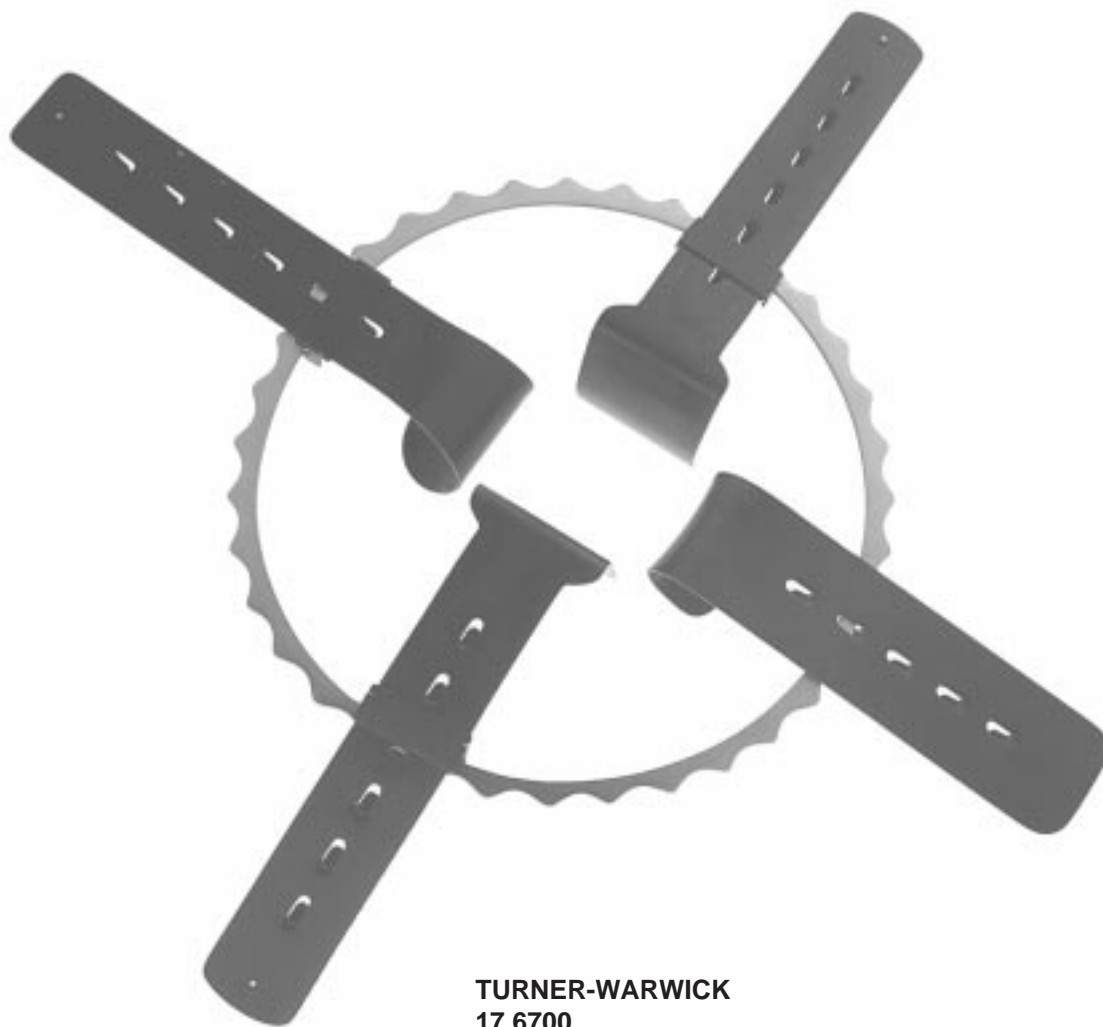

**TURNER-WARWICK  
17.6700**

bestehend aus

consisting of:

comprendant:

compuesto de:

composta da:

17.6701 1

17.6702 1

17.6703 1

17.6710 2

17.6711 2

17.6712 2

17.6713 2

17.6714 2

17.6715 2

17.6716 2

17.6717 2



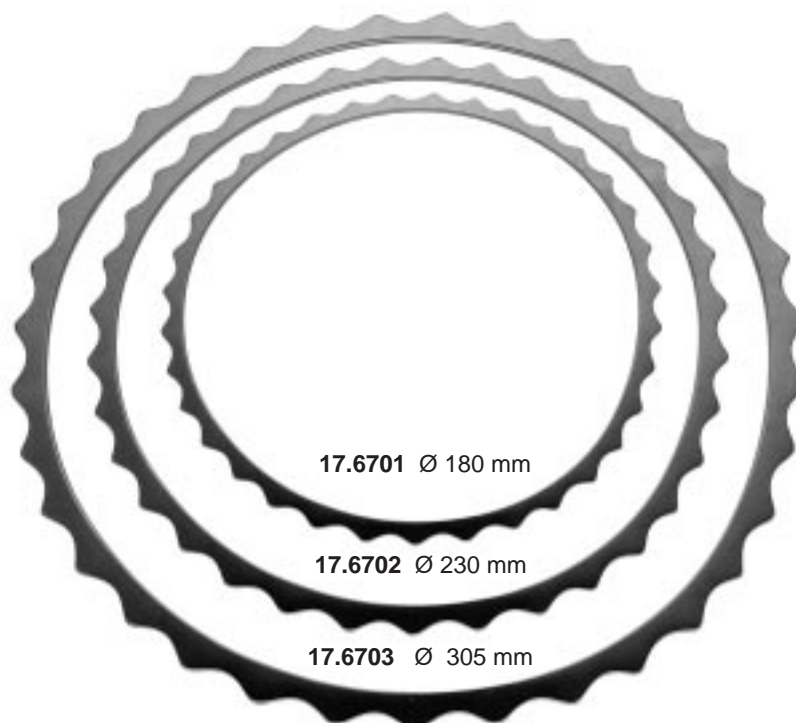

17.6701 Ø 180 mm

17.6702 Ø 230 mm

17.6703 Ø 305 mm

**TURNER-WARWICK**

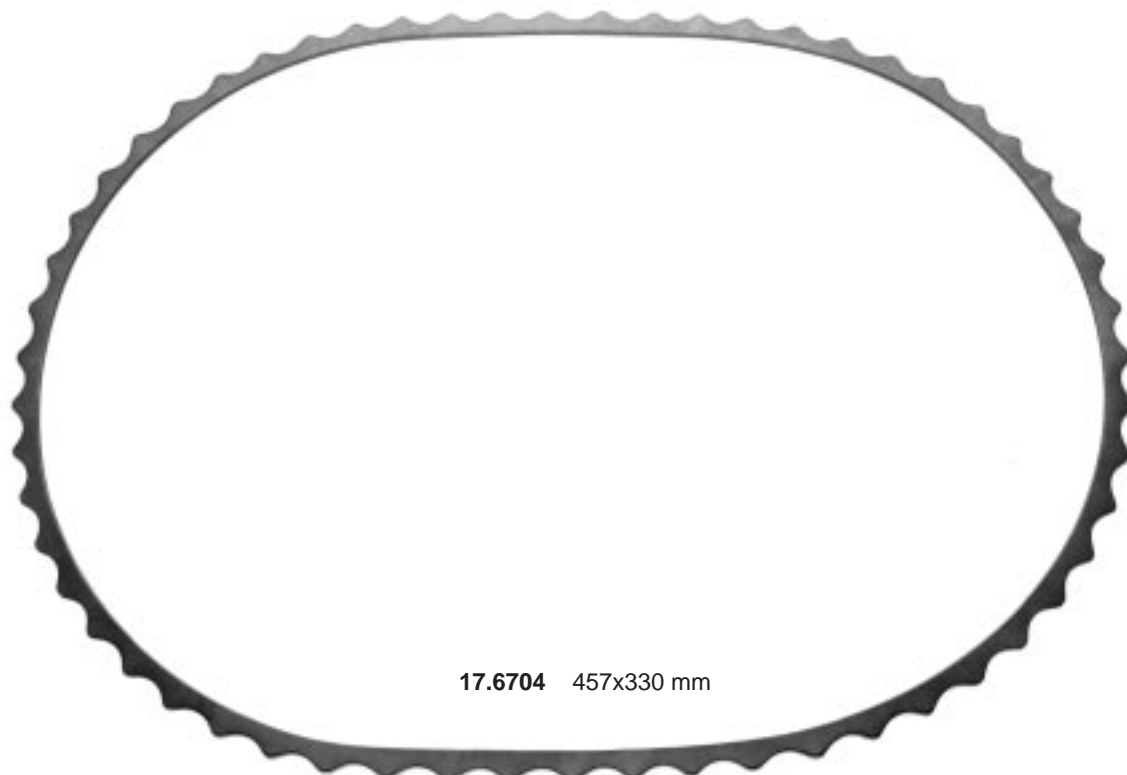

17.6704 457x330 mm

**TURNER-WARWICK**



**TURNER-WARWICK**  
17.6710 76 x 19 mm

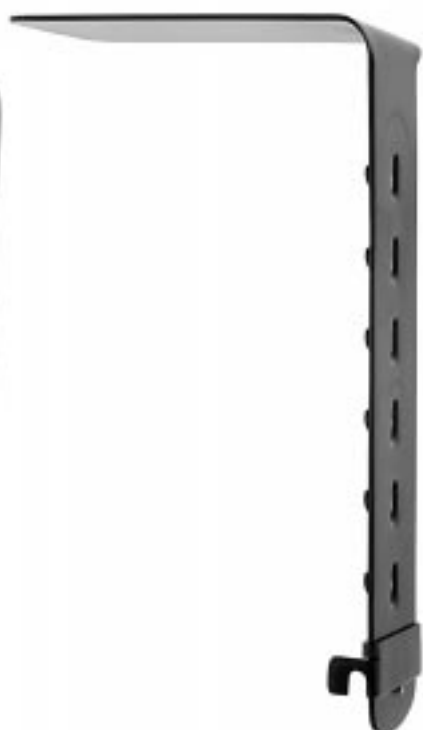

**TURNER-WARWICK**  
17.6711 102 x 38 mm



**TURNER-WARWICK**  
17.6712 89 x 57 mm



**TURNER-WARWICK**  
17.6713 114 x 57 mm



**TURNER-WARWICK**  
17.6714 51 x 38 mm



**TURNER-WARWICK**  
17.6715 76 x 60 mm

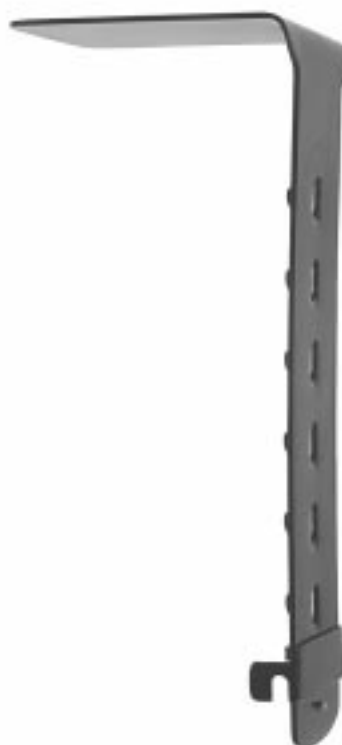

**TURNER-WARWICK**  
17.6716 89 x 60 mm  
17.6717 114 x 60 mm



**TURNER-WARWICK**  
17.6718 13 mm

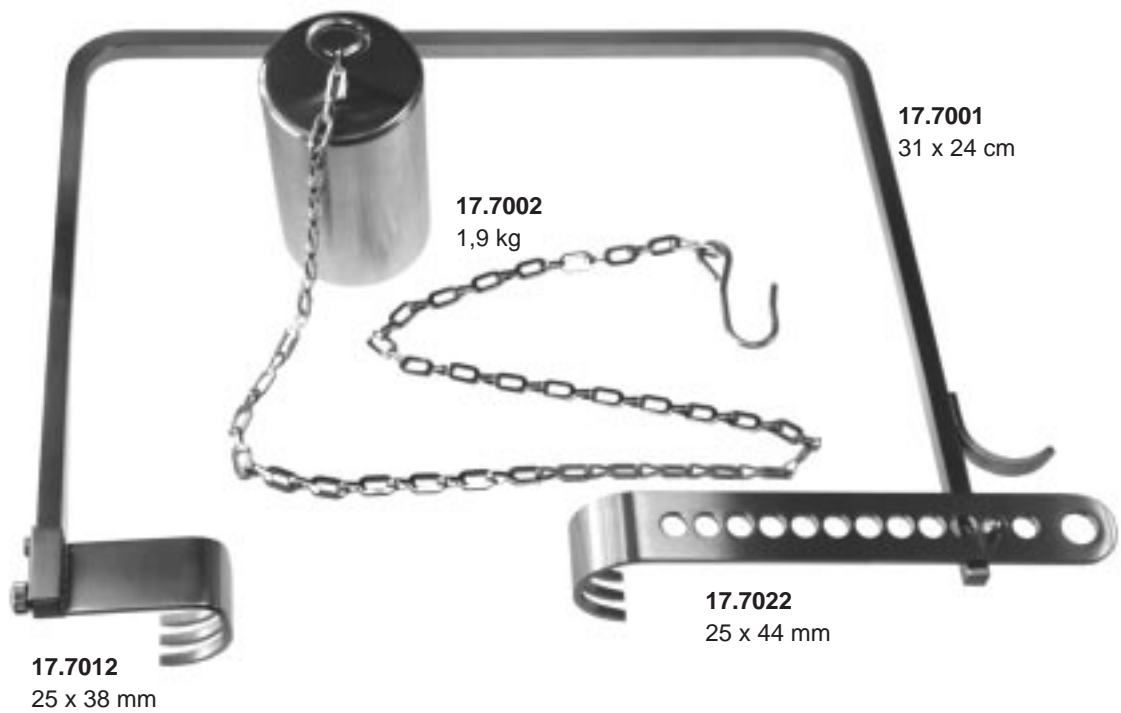

**CHARNLEY compl.**  
**17.7000**

bestehend aus:

consisting of:

comprendant:

compuesto de:

composta da:

17.7001 Rahmen / Frame / Cadre / Cuadro / Telaio 31 x 24 cm

17.7002 Gewicht mit Kette / Weight with chain / poids avec chaîne /  
peso con cadena / peso con catena

17.7012 Valve /Valve / Valva / Valve 25 x 38 mm

17.7022 Valve /Valve / Valva / Valve 25 x 44 mm



**CLOWARD**

**17.8000** 17 cm  
mit je 2 Valven 17.8002 - 17.8006  
with 2 ea. Valves 17.8002 - 17.8006  
avec 2 paires de valves 17.8002 - 17.8006  
con 2 valvas de c.u. Ref. 17.8002 - 17.8006  
con 2 valve ad innesto 17.8002 - 17.8006

**17.8001** 17 cm  
Sperrer allein  
Spreader only  
Ecarteur seul  
Separador suelto  
Divaricatore solo

stumpf  
blunt  
mousse  
romo  
smusso



**CLOWARD**  
**17.8002** 40 mm



**17.8003** 45 mm



**17.8004** 50 mm



**17.8005** 55 mm



**17.8006** 60 mm

**17.8007**  
Satz mit 5 Valven 17.8002 - 17.8006  
Set of 5 Blades 17.8002 - 17.8006  
Jeu de 5 valves 17.8002 - 17.8006  
Juego de 5 valvas 17.8002 - 17.8006  
Serie di 5 valve 17.8002 - 17.8006



## CLOWARD

**17.8010** 25 cm  
 mit je 2 Valven 17.8012 - 17.8016  
 with 2 ea. Valves 17.8012 - 17.8016  
 avec 2 paires de valves 17.8012 - 17.8016  
 con 2 valvas de c.u. Ref. 17.8012 - 17.8016  
 con 2 valve ad innesto 17.8012 - 17.8016

**17.8011** 25 cm  
 Sperrer allein  
 Spreader only  
 Ecarteur seul  
 Separador suelto  
 Divaricatore solo

gezahnt  
 serrated  
 dentelé  
 dentada  
 dentate



**17.8012** 40 mm

**17.8013** 45 mm

**17.8014** 50 mm

**17.8015** 55 mm

**17.8016** 60 mm

**17.8017**  
 Satz mit 5 Valven 17.8012 - 17.8016  
 Set of 5 Blades 17.8012 - 17.8016  
 Jeu de 5 valves 17.8012 - 17.8016  
 Juego de 5 valvas 17.8012 - 17.8016  
 Serie di 5 valve 17.8012 - 17.8016



**17.8042** 45 x 35 mm  
**17.8043** 45 x 45 mm  
 spitz  
 sharp  
 pointu  
 agudo  
 acuto



**17.8044** 25 x 35 mm  
**17.8045** 25 x 45 mm  
 stumpf  
 blunt  
 mousse  
 romo  
 smusso



**17.8052**  
 50 mm



**17.8053**  
 64 mm

**HOEN**

**17.8040** 27 cm  
 mit 4 Valven 17.8042 - 17.8045  
 with 4 blades 17.8042 - 17.8045  
 avec 4 valves 17.8042 - 17.8045  
 con 4 valvas 17.8042 - 17.8045  
 con 4 valve 17.8042 - 17.8045

**17.8041** 27 cm  
 Sperrer allein / Spreader only  
 Ecarteur seul  
 Separador suelto / Divaricatore solo

**CLOWARD-HOEN**

**17.8050** 25 cm  
 mit je 2 Valven 17.8052, 17.8053  
 with 2 ea. Valves 17.8052, 17.8053  
 avec 2 paires de valves 17.8052, 17.8053  
 con 2 valvas de c.u. Ref. 17.8052, 17.8053  
 con 2 valve ad innesto 17.8052, 17.8053

**17.8051** 25 cm  
 Sperrer allein / Spreader only / Ecarteur seul  
 Separador suelto / Divaricatore solo



**MISKIMON**  
17.8060 21cm  
32 x 35 mm

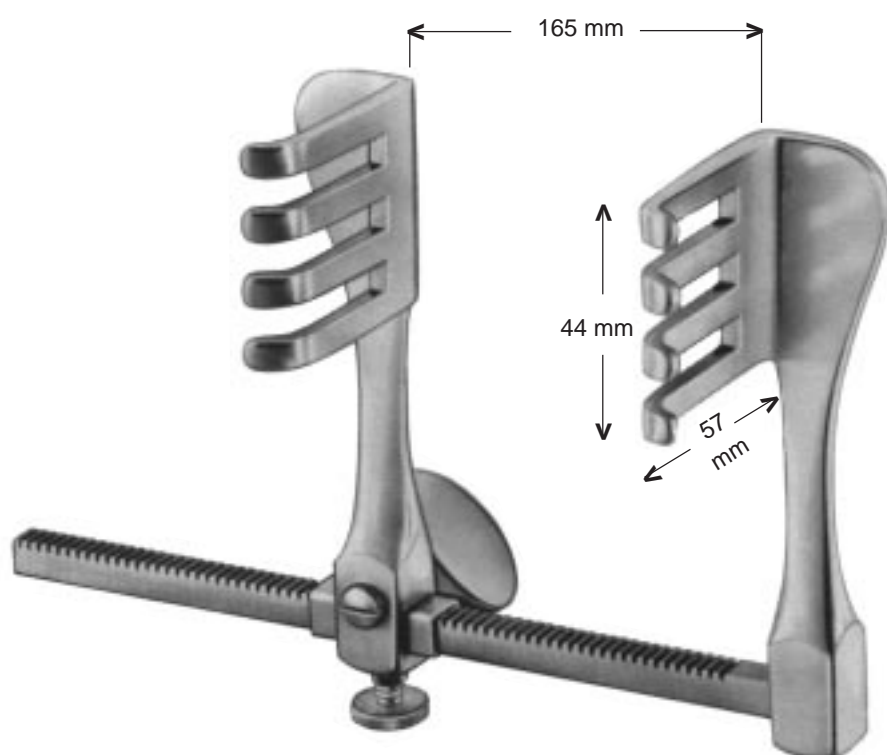

**BADGLEY**  
17.8100





## SCOVILLE-RICHTER

### 17.8130

bestehend aus:

- 17.8131 Rahmen, Spreizweite 14 cm
- 17.8132 Seitenvalve 3-zahnig 35 x 60 mm
- 17.8133 Seitenvalve 4-zahnig 50 x 60 mm

consisting of:

- 17.8131 Frame, spreading 14 cm
- 17.8132 Blade 3-prong, 35 x 60 mm
- 17.8133 Blade 4-prong, 50 x 60 mm

comprenant:

- 17.8131 Cadre, écartement 14 cm
- 17.8132 Valve à 3 dents 35 x 60 mm
- 17.8133 Valve à 4 dents 50 x 60 mm

compuesto de:

- 17.8131 Bastidor, extensión 14 cm
- 17.8132 Valva con 3 dientes 35 x 60 mm
- 17.8133 Valva con 4 dientes 50 x 60 mm

composto di:

- 17.8131 Telaio, apertura 14 cm
- 17.8132 valva con 3 denti, 35 x 60 mm
- 17.8133 valva con 4 denti, 50 x 60 mm

### 17.8131

Sperrer allein / Spreader only / Ecarteur seul / Separador  
suelto / Divaricatore solo



## SCOVILLE-RICHTER

17.8132 35x60 mm



17.8133 50x60 mm



17.8134 40x28 mm



17.8135 50x50 mm



17.8136 62x38 mm

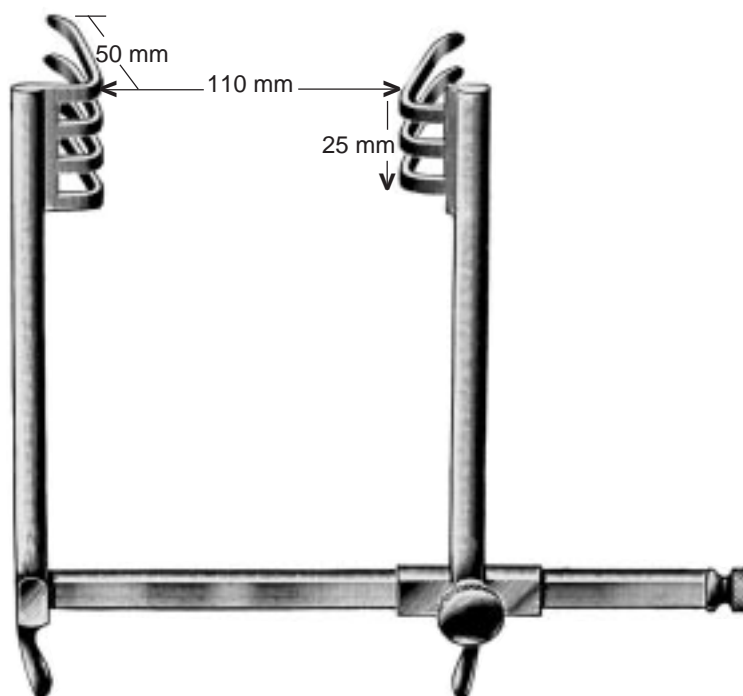

**TEMPLE-FAY**  
17.8155



**SCOVILLE**

**17.8161**

bestehend aus:

17.8160 Rahmen, Spreizweite 15 cm

17.8172 Haken, stumpf 50 mm

17.8174 Valve gezahnt 64 x 24 mm

consisting of:

17.8160 Frame, spreading 15 cm

17.8172 blunt hook, 50 mm

17.8174 toothed blade 64 x 25 mm

comprenant:

17.8160 Cadre, écartement 15 cm

17.8172 Crochet mousse, 50 mm

17.8174 Valve dentelé 64 x 25 mm

compuesto de:

17.8160 Bastidor, extensión 15 cm

17.8172 Gancho romo, 50 mm

17.8174 Valva dentado 64 x 25 mm

composto di:

17.8160 Telaio, apertura 15 cm

17.8172 Uncino smusso 50 mm

17.8174 Valva dentato 64 x 25 mm

**17.8160**

Sperrer allein / Spreader only / Ecarteur seul /  
Separador suelto / Divaricatore solo



## SCOVILLE-HAVERFIELD

### 17.8164

bestehend aus:

- 17.8165 Rahmen mit Gelenk, Spreizweite 15 cm
- 17.8170 Haken, spitz 50 mm
- 17.8174 Valve gezahnt 64 x 24 mm

consisting of:

- 17.8165 Frame with joint, spreading 15 cm
- 17.8170 sharp hook, 50 mm
- 17.8174 toothed blade 64 x 25 mm

comprenant:

- 17.8165 Cadre avec articulation, écartement 15 cm
- 17.8170 Crochet pointu, 50 mm
- 17.8174 Valve dentelé 64 x 25 mm

compuesto de:

- 17.8165 Bastidor con articulación, extensión 15 cm
- 17.8170 Gancho agudo, 50 mm
- 17.8174 Valva dentado 64 x 25 mm

composto di:

- 17.8165 Telaio con articolazione, apertura 15 cm
- 17.8170 Uncino acuto 50 mm
- 17.8174 Valva dentato 64 x 25 mm

### 17.8165

Rahmen mit Gelenk Spreizweite 15 cm

Frame with joint, spreading 15 cm

Cadre avec articulation, écartement 15 cm

Bastidor con articulación, extension 15 cm

Telaio con articolazione, apertura 15 cm



### SCOVILLE

17.8170 50 mm

17.8171 75 mm

spitz  
sharp  
pointu  
agudo  
acuto



### SCOVILLE

17.8172 50 mm

17.8173 75 mm

stumpf  
blunt  
mousse  
romo  
smusso



### SCOVILLE

17.8174 64 x 25 mm

17.8175 64 x 50 mm

17.8177 88 x 25 mm



### SCOVILLE

17.8178 41 x 38 mm

17.8179 67 x 44 mm



**TAYLOR**

**17.8181** 48 x 51 mm

**17.8182** 64 x 50 mm

**17.8183** 80 x 57 mm



**TAYLOR**

**17.8185** 75 x 32 mm

**17.8186** 100 x 42 mm



**HIBBS**

**17.8187** 50 x 19 mm

**17.8188** 50 x 25 mm

**17.8189** 50 x 50 mm

**17.8190** 64 x 25 mm

**17.8191** 64 x 38 mm

**17.8192** 75 x 25 mm

**17.8193** 75 x 38 mm

**17.8194** 75 x 50 mm

**17.8195** 100 x 25 mm

**17.8196** 100 x 50 mm



**MEYERDING**

**17.8201** 50 x 25 mm

**17.8203** 75 x 25 mm

**17.8205** 90 x 50 mm

<b>17.6542 MODULAR RETRAKTOR KIT II</b>		
bestehend aus:		Anzahl
17.6552	horizontale Stange	1
17.6554	Pfosten-Kupplung	1
17.6557	ovaler Rahmen 368 x 267 mm	1
17.6561	Spatel 51 x 152 mm biegsam	2
17.6562	Spatel 38 x 152 mm biegsam	1
17.6566	HARRINGTON Haken	1
17.6567	Spatel 72 x 152 mm biegsam	1
17.6568	KELLY Haken 51 x 76 mm	2
17.6569	KELLY Haken 51 x 102 mm	1
17.6570	KELLY Haken 51 x 127 mm	1
17.6571	KELLY Haken 51 x 152 mm	1
17.6576	BALFOUR Haken 67 x 76 mm	1
17.6577	GELPI Haken	1
17.6579	Standard Rasten	2
17.6580	Rasten schräg	6
17.6581	Tischpfosten	1
17.6582	Stange flexibel horizontal	1
17.6583	Rahmen geteilt 266 x 495 mm	1

<b>17.6546 MODULAR REKTAL KIT</b>		
bestehend aus:		Anzahl
17.6584	runder Rahmen 216 mm	1
17.6585	Rektalvalve 73 mm lang	2
17.6586	Rektalvalve 98 mm lang	2

<b>17.6547 MODULAR VAGINAL KIT</b>		
bestehend aus:		Anzahl
17.6554	PfostenKupplung	1
17.6580	Rasten schräg	4
17.6581	Tischpfosten	1
17.6582	Stange flexibel horizontal	1
17.6590	Vaginal Rahmen 203 x 266 mm	1
17.6591	MAGRINA Vaginal Haken 25 x 76 mm	1
17.6592	DEAVER Haken 25 x 89 mm	1
17.6593	DEAVER Haken 25 x 127 mm	1
17.6594	Vaginalhaken 25 x 114 mm	1

<b>17.6578 MODULAR KIT FÜR KLEINE ERÖFFNUNGEN</b>		
bestehend aus:		Anzahl
17.6563	KELLY Spatel 51 x 51mm	1
17.6574	KELLY Haken 25 x 38 mm	1
17.6575	KELLY Haken 25 x 63 mm	1
17.6577	GELPI Haken	1
17.6584	runder Rahmen 216 mm	1

**Sonderzubehör:**

17.6553	Verlängerungsteil 305 mm
17.6556	ovaler Rahmen 267x470 mm
17.6558	ovaler Rahmen 203 x 311 mm
17.6559	runder Rahmen 266 mm
17.6560	runder Rahmen 317 mm
17.6565	KELLY Spatel 51 x 38 mm
17.6572	KELLY Haken 51 x 64mm
17.6587	Rahmen geteilt 216 x 356 mm
17.6588	Rahmen geteilt 317 x 495 mm
17.6635	Ring Segmente 216 mm (Paar)
17.6639	SCOVILLE Haken 50 mm
17.6640	SCOVILLE Haken 83 mm
17.6641	MEYERDING Haken 60x17 mm
17.6642	MEYERDING Haken 85x25 mm
17.6643	MEYERDING Haken 95x50 mm
17.6644	Haken 3-zahnig 19x17 mm
17.6645	Haken 4-zahnig 8x19 mm
17.6646	Haken 6-zahnig 8x25 mm

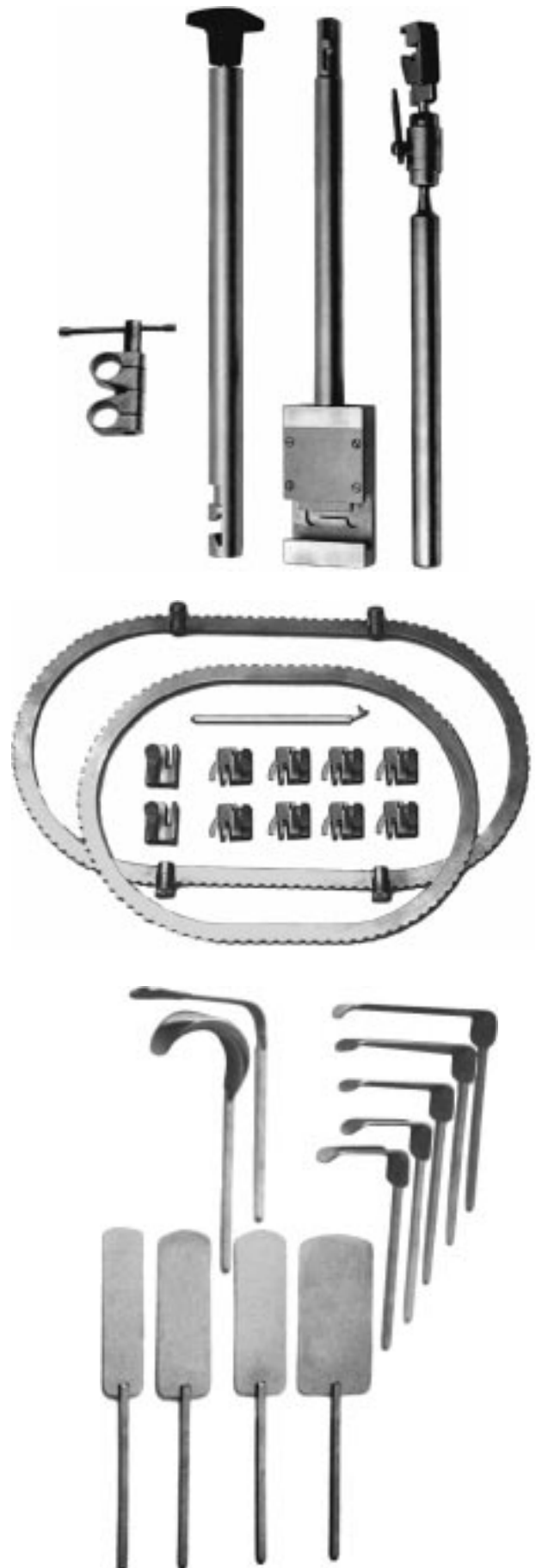

17.6542	<b>MODULAR RETRACTOR KIT II</b>	
	consisting of	Quantity
17.6552	Horizontal Bar	1
17.6554	Post Coupling	1
17.6557	Medium Oval Ring	1
17.6561	Spatulas mall. 152 x 51 mm	2
17.6562	"Spatula 6" x 1 1/2" malleable"	1
17.6566	HARRINGTON Retractor	1
17.6567	Spatula 72 x 152 mm malleable	1
17.6568	KELLY Retractor 51 x 76 mm	2
17.6569	KELLY Retractor 51 x 102 mm	1
17.6570	KELLY Retractor 51 x 127 mm	1
17.6571	KELLY Retractor 51 x 152 mm	1
17.6576	BALFOUR Blade 67 x 76 mm	1
17.6577	GELPI Point Blade	1
17.6579	Standard Ratchets	2
17.6580	Tilt Ratchets	6
17.6581	Table Post	1
17.6582	flexible Bar horizontal	1
17.6583	Segmented Ring 10 1/2 x 19 1/2"	1

17.6546	<b>MODULAR RECTAL KIT</b>	
	consisting of	Quantity
17.6584	Medium Round Ring 8 1/2" i.d"	1
17.6585	Rectal Blade 7/8" x 2 7/8"	2
17.6586	Rectal Blade 7/8" x 3 7/8"	2

17.6547	<b>MODULAR VAGINAL KIT</b>	
	consisting of	Quantity
17.6554	Post Coupling	1
17.6580	Tilt Ratchets	4
17.6581	Table Post	1
17.6582	flexible Bar horizontal	1
17.6590	Vaginal Retractor Ring 8 x 10 1/2"	1
17.6591	MAGRINA Vag. Retractor lateral blade	1
17.6592	DEAVER Blade 1" x 3 1/2"	1
17.6593	DEAVER Blade 1" x 5"	1
17.6594	DEAVER Blade 1" x 4 1/2"	1

17.6578	<b>MODULAR SMALL INCISION KIT</b>	
	consisting of	Quantity
17.6563	KELLY Spatula 2" x 2"	1
17.6574	KELLY Retractor 25 x 38 mm	1
17.6575	KELLY Retractor 25 x 63 mm	1
17.6577	GELPI Point Blade	1
17.6584	Medium Round Ring 8 1/2" i.d"	1

<b>Optional accessories:</b>	
17.6553	Vertical Extension Bar 12"
17.6556	Large Oval Ring 12" x 18 1/2"
17.6558	Small Oval Ring 8" x 12 1/4"
17.6559	Medium Round Ring 10 1/2" i."
17.6560	Large Round Ring 12 1/2" i."
17.6565	KELLY Spatula 2" x 1 1/2"
17.6572	KELLY Retractor 51 x 64mm
17.6587	Segmented Ring 8 1/2 x 14"
17.6588	Segmented Ring 12 1/2 x 19 1/2"
17.6635	Ring Segments 8 1/2" (pair)"
17.6639	SCOVILLE Hook 2"
17.6640	SCOVILLE Hook 3 1/4"
17.6641	MEYERDING Hook 2 1/3" x 1/3"
17.6642	MEYERDING Hook 3 1/3" x 1"
17.6643	MEYERDING Hook 3 3/4" x 2"
17.6644	Hook 3 pr. 3/4" x 2/3"
17.6645	Hook 4 pr. 1/3" x 3/4"
17.6646	Hook 6 pr. 1/3" x 1"

17.6542	<b>MODULAR ECARTEUR KIT II</b>	
	comprenant:	quantité
17.6552	Pied horizontal	1
17.6554	Connecteur p. rallongement	1
17.6557	Cadre medium	1
17.6561	Spatules mall 152x51 mm	2
17.6562	Spatule 38 x 152 mm malleable	1
17.6566	HARRINGTON Ecarteur	1
17.6567	Spatule 72 x 152 mm malleable	1
17.6568	KELLY Ecartuer 51 x 76 mm	2
17.6569	KELLY Ecartuer 51 x 102 mm	1
17.6570	KELLY Ecarteur 51 x 127 mm	1
17.6571	KELLY Ecarteur 51 x 152 mm	1
17.6576	BALFOUR Ecartuer 67 x 76 mm	1
17.6577	GELPI Ecarteur	1
17.6579	Crémaillère standard	2
17.6580	Crémaillère oblique	6
17.6581	Pied de Table	1
17.6582	Bras flexible horizontal	1
17.6583	Cadre segmentaire 266 x 495	1

17.6546	<b>MODULAR RECTAL KIT</b>	
	comprenant:	quantité
17.6584	Cadre ronde 216 mm	1
17.6585	Valve rectale 73 mm	2
17.6586	Valve rectale 98 mm	2

17.6547	<b>MODULAR VAGINAL KIT</b>	
	comprenant:	quantité
17.6554	Connecteur p.rallongement	1
17.6580	Crémaillère oblique	4
17.6581	Pied de Table	1
17.6582	Bras flexible horizontal	1
17.6590	Cadre vaginal 203 x 266 mm	1
17.6591	MAGRINA Ecarteur vaginal latéral 25 x 76 mm	1
17.6592	DEAVER Valve 25 x 89 mm	1
17.6593	DEAVER Valve 25 x 127 mm	1
17.6594	Valve vginale 25 x 114 mm	1

17.6578	<b>MODULAR BOITE POUR PETITES INCISIONS</b>	
	comprenant:	quantité
17.6563	KELLY Spatule 51 x 51 mm	1
17.6574	KELLY Ecarteur 25 x 38 mm	1
17.6575	KELLY Ecarteur 25 x 63 mm	1
17.6577	GELPI Ecarteur	1
17.6584	Cadre ronde 216 mm	1

<b>Accessoires optionels:</b>	
17.6553	Pièce/ rallongement 305 mm
17.6556	cadre oval 267 x 470 mm
17.6558	Cadre 203 x 311 mm
17.6559	Cadre ronde 266 mm
17.6560	Cadre ronde 317 mm
17.6565	KELLY Spatule 51 x 38 mm
17.6572	KELLY Ecarteur 51 x 64 mm
17.6587	Cadre segmentaire 216 x 356
17.6588	Cadre segmentaire 317 x 495
17.6635	Segment semi-circulaire Paire 216 mm
17.6639	SCOVILLE Crochet 50 mm
17.6640	SCOVILLE Crochet 83 mm
17.6641	MEYERDING Crochet 60x17 mm
17.6642	MEYERDING Crochet 85x25 mm
17.6643	MEYERDING Crochet 95x50 mm
17.6644	Crochet 3 dents 19x17 mm
17.6645	Crochet 4 dents 8x19 mm
17.6646	Crochet 6 dents 8x25 mm

17.6542	<b>MODULAR SEPARADOR KIT II</b>		
compuesto de:		cantidad	
17.6552	Poste horizontal	1	
17.6554	Connector p. empalme	1	
17.6557	Quadro medial	1	
17.6561	Espatulas mall.152x51 mm	2	
17.6562	Espatula 38 x 152 mm malleabl	1	
17.6566	HARRINGTON Separador	1	
17.6567	Espatula 72x152 mm malleable	1	
17.6568	KELLY Separador 51 x 76 mm	2	
17.6569	KELLY Separador 51 x 102 mm	1	
17.6570	KELLY Separador 51 x 127 mm	1	
17.6571	KELLY Separador 51 x 152 mm	1	
17.6576	BALFOUR Separador 67 x 76 mm	1	
17.6577	GELPI Separador	1	
17.6579	Cremallera standard	2	
17.6580	Cremallera obliquo	6	
17.6581	Poste vertical	1	
17.6582	Brazo flex. horizontal	1	
17.6583	Cuadro en segmentos 266 x 495 mm	1	

17.6546	<b>MODULAR RECTAL KIT</b>		
compuesto de:		cantidad	
17.6584	Quadro rondo 216 mm	1	
17.6585	Valva rectal 73 mm	2	
17.6586	Valva rectal 98 mm	2	

17.6547	<b>MODULAR VAGINAL KIT</b>		
compuesto de:		cantidad	
17.6554	Connector p. empalme	1	
17.6580	Cremallera obliquo	4	
17.6581	Poste vertical	1	
17.6582	Brazo flex. horizontal	1	
17.6590	Cuadro vaginal 203 x 266 mm	1	
17.6591	MAGRINA Separador vaginal lateral 25x76mm	1	
17.6592	DEAVER Valva 25 x 89 mm	1	
17.6593	DEAVER Valva 25 x 127 mm	1	
17.6594	Valva vaginal 25 x 114 mm	1	

17.6578	<b>MODULAR KIT PARA INCISIONES PEQUENAS</b>		
compuesto de:		cantidad	
17.6563	KELLY Espatula 51 x 51 mm	1	
17.6574	KELLY Separador 25 x 38 mm	1	
17.6575	KELLY Separador 25 x 63 mm	1	
17.6577	GELPI Separador	1	
17.6584	Quadro rondo 216 mm	1	

### Accesorios opcionales:

17.6553	Pieza de empalme 305 mm
17.6556	Cuadro oval 267 x 470 mm
17.6558	Cuadro 203 x 311 mm
17.6559	Quadro rondo 266 mm
17.6560	Quadro rondo 317 mm
17.6565	KELLY Espatula 51 x 38 mm
17.6572	KELLY Separador 51 x 64 mm
17.6587	Cuadro en segmentos 216 x 356 mm
17.6588	Cuadro en segmentos 317 x 495 mm
17.6635	Segmento semi-circular (par) 216 mm
17.6639	SCOVILLE Gancho 50 mm
17.6640	SCOVILLE Gancho 83 mm
17.6641	MEYERDING Gancho 60x17 mm
17.6642	MEYERDING Gancho 85x25 mm
17.6643	MEYERDING Gancho 95x50 mm
17.6644	Gancho 3 dientes 19x17 mm
17.6645	Gancho 4 dientes 8x19 mm
17.6646	Gancho 6 dientes 8x25 mm

17.6542	<b>MODULAR DIVARICATORE KIT II</b>		
composta da:		quantita	
17.6552	Gambo orizzontale	1	
17.6554	Agganciamento di montante	1	
17.6557	Telaio ovale 368x267 mm	1	
17.6561	Spatola flessibile 152 x 51 mm	2	
17.6562	Spatola flessibile 389 x 152 mm	1	
17.6566	HARRINGTON Gancio	1	
17.6567	Spatola flessibile 72x152 mm	1	
17.6568	KELLY Gancio 51 x 76 mm	2	
17.6569	KELLY Gancio 51 x 102 mm	1	
17.6570	KELLY Gancio 51 x 127 mm	1	
17.6571	KELLY Gancio 51 x 152 mm	1	
17.6576	BALFOUR Gancio 67 x 76 mm	1	
17.6577	GELPI Gancio	1	
17.6579	Cremagliera standard	2	
17.6580	Cremagliera obliqua	6	
17.6581	Montante di tavola	1	
17.6582	Montane orizzontale flessibile	1	
17.6583	Telaio en segmentos 266 x 495 mm	1	

17.6546	<b>MODULAR RECTAL KIT</b>		
composta da:		quantita	
17.6584	Telaio mediano tondo 216 mm	1	
17.6585	Valva rettale 73 mm	2	
17.6586	Valva rettale 98 mm	2	

17.6547	<b>MODULAR VAGINAL KIT</b>		
composta da:		quantita	
17.6554	Agganciamento di montante	1	
17.6580	Cremagliera obliqua	4	
17.6581	Montante di tavola	1	
17.6582	Montane orizzontale flessibile	1	
17.6590	Telaio vaginal 203 x 266 mm	1	
17.6591	MAGRINA Gancio vaginal lateral 25x76mm	1	
17.6592	DEAVER Valva 25x89 mm	1	
17.6593	DEAVER Valva 25x127 mm	1	
17.6594	DEAVER Valva 25x114 mm	1	

17.6578	<b>MODULAR KIT PER PICCOLE INCISIONE</b>		
composta da:		quantita	
17.6563	KELLY Spatola 51 x 51 mm	1	
17.6574	KELLY Gancio 25 x 38 mm	1	
17.6575	KELLY Gancio 25 x 63 mm	1	
17.6577	GELPI Gancio	1	
17.6584	Telaio mediano tondo 216 mm	1	

### Accessori opzionali:

17.6553	Gambo / prolunga verticale 305mm
17.6556	Telaio ovale 267x470 mm
17.6558	Telaio ovale 203x311 mm
17.6559	Telaio tondo 266 mm
17.6560	Telaio tondo 317 mm
17.6565	KELLY Spatola 51 x 38 mm
17.6572	KELLY Gancio 51 x 64 mm
17.6587	Telaio en segmenti 216 x 356 mm
17.6588	Telaio en segmenti 317 x 495 mm
17.6635	Segmenti semi-circular 216 mm (paio)
17.6639	SCOVILLE Gancio 50 mm
17.6640	SCOVILLE Gancio 83 mm
17.6641	MEYERDING Gancio 60 x 17 mm
17.6642	MEYERDING Gancio 85 x 25 mm
17.6643	MEYERDING Gancio 95 x 50 mm
17.6644	Gancio 3 denti 19 x 17 mm
17.6645	Gancio 4 denti 8 x 19 mm
17.6646	Gancio 6 denti 8 x 25 mm



**PRO-MED**

**27.1480**

Laminektomiesperrer Aluminium  
Laminectomy retractor only Aluminium  
Ecarteur pour laminectomie Aluminium  
Separador para laminectomia Aluminium  
Divaricatore per laminectomia Aluminium

bestehend aus:

27.1481 Sperrer alleine  
27.1485 - 2 Paar Valven 40 x 12 mm  
27.1486 - 2 Paar Valven 50 x 12 mm  
27.1487 - 2 Paar Valven 65 x 12 mm

consisting of:

27.1481 Retractor only  
27.1485 - 2 pairs of valves 40 x 12 mm  
27.1486 - 2 pairs of valves 50 x 12 mm  
27.1487 - 2 pairs of valves 65 x 12 mm

comprenant:

27.1481 Ecarteur seul  
27.1485 - 2 paires de valves 40 x 12 mm  
27.1486 - 2 paires de valves 50 x 12 mm  
27.1487 - 2 paires de valves 65 x 12 mm

compuesto de:

27.1481 Separador suelto  
27.1485 - 2 pares valvas 40 x 12 mm  
27.1486 - 2 pares valvas 50 x 12 mm  
27.1487 - 2 pares valvas 65 x 12 mm

composta da:

27.1481 Separatore solo  
27.1485 - 2 paia di valve 40 x 12 mm  
27.1486 - 2 paia di valve 50 x 12 mm  
27.1487 - 2 paia di valve 65 x 12 mm

**27.1481**

Sperrer allein / Spreader only / Ecarteur seul /  
Separador suelto / Divaricatore solo

Ersatzvalven  
Spare valves  
Valves de rechange  
Valvas di ricambio  
Valve die ricambio



**27.1485** 40 x 12 mm

**27.1486** 50 x 12 mm

**27.1487** 65 x 12 mm

Paar  
pair  
paire  
par  
paio





**CLOWARD**

**27.1451**

16 cm

Spreizweite	15 mm
opening	15 mm
écartement	15 mm
abertura	15 mm
apertura	15 mm



**CLOWARD**

**27.1455**

13 cm

Spreizweite	20 mm
opening	20 mm
écartement	20 mm
abertura	20 mm
apertura	20 mm

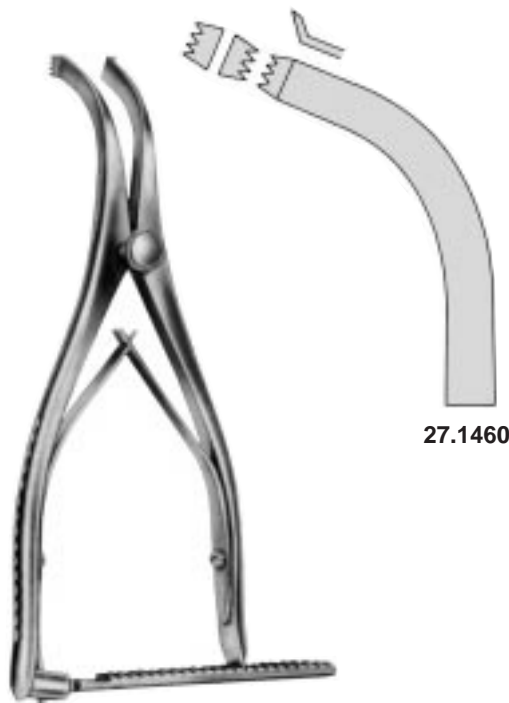

**INGE-BABY**

17 cm

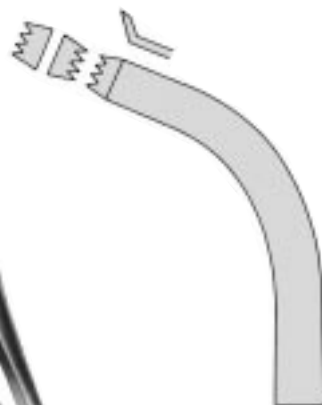

27.1460



27.1461



**INGE**  
27 cm



**27.1465**  
9 mm

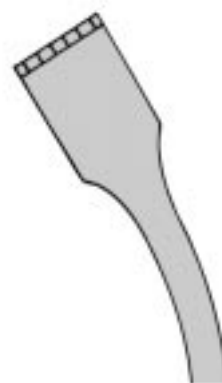

**27.1466**  
12 mm



**CASPAR**  
**27.5050**

Sperrer komplett mit 5 Valven 27.5062, 27.5072 - 27.5076  
Retractor complete with 5 blades 27.5062, 27.5072 - 27.5076  
Ecarteur complet avec 5 valves 27.5062, 27.5072 - 27.5076  
Separador completo con 5 valvas 27.5062, 27.5072 - 27.5076  
Divaricatore completo con 5 valve 27.5062, 27.5072 - 27.5076

**27.5051**

Sperrer allein / retractor only / ecarteur seul  
separador solamente / divaricatore solo



**27.5062** 38 mm



**27.5063** 58 mm



- 27.5071** 32 x 22 mm
- 27.5072** 37 x 22 mm
- 27.5073** 43 x 22 mm
- 27.5074** 47 x 22 mm
- 27.5075** 52 x 22 mm
- 27.5076** 57 x 22 mm
- 27.5077** 62 x 22 mm
- 27.5078** 67 x 22 mm



- 27.5081** 32 x 37 mm
- 27.5082** 37 x 37 mm
- 27.5083** 43 x 37 mm
- 27.5084** 47 x 37 mm
- 27.5085** 52 x 37 mm
- 27.5086** 57 x 37 mm
- 27.5087** 62 x 37 mm
- 27.5088** 67 x 37 mm



- 27.5091** 32 x 52 mm
- 27.5092** 37 x 52 mm
- 27.5093** 43 x 52 mm
- 27.5094** 47 x 52 mm
- 27.5095** 52 x 52 mm
- 27.5096** 57 x 52 mm
- 27.5097** 62 x 52 mm
- 27.5098** 67 x 52 mm



**CASPAR**

17 cm

**27.5000**

Sperrer komplett mit 7 Valven 27.5021 - 27.5027

Retractor complete with 7 blades 27.5021 - 27.5027

Ecarteur complet avec 7 valves 27.5021 - 27.5027

Separador completo con 7 valvas 27.5021 - 27.5027

**27.5001**

Sperrer allein / retractor only

ecarteur seul / separador solamente

27.5021 40 mm



27.5022 45 mm



27.5023 50 mm



27.5024 55 mm



27.5025 60 mm



27.5026 65 mm



27.5027 70 mm





**CASPAR**  
**27.5100**

Sperrer komplett mit 5 Valven 27.5183 - 27.5187  
 Retractor complete with 5 blades 27.5183 - 27.5187  
 Ecarteur complet avec 5 valves 27.5183 - 27.5187  
 Separador completo con 5 valvas 27.5183 - 27.5187  
 Divaricatore completo con 5 valve 27.5183 - 27.5187

**27.5101**

Sperrer allein / retractor only  
 ecarteur seul / separador solamente / divaricatore solo



**CASPAR**  
**27.5110**

Sperrer komplett mit 5 Valven 27.5183 - 27.5187  
 Retractor complete with 5 blades 27.5183 - 27.5187  
 Ecarteur complet avec 5 valves 27.5183 - 27.5187  
 Separador completo con 5 valvas 27.5183 - 27.5187  
 Divaricatore completo con 5 valve 27.5183 - 27.5187

**27.5111**

Sperrer allein / retractor only  
 ecarteur seul / separador solamente / divaricatore solo



**CASPAR**  
**27.5120**

Cervicalsperrer mit je 1 Valve  
 27.5132 - 27.5136; 27.5152 - 27.5156

Cervical Retractor complete with 1 ea. Valve  
 27.5132 - 27.5136; 27.5152 - 27.5156

Ecarteur cervical complet avec 1 chacun  
 27.5132 - 27.5136; 27.5152 - 27.5156

Separador cervical completo con 1 c/u  
 27.5132 - 27.5136; 27.5152 - 27.5156

Divaricatore completo con 1 ciascuno  
 27.5132 - 27.5136; 27.5152 - 27.5156

**27.5121**

Sperrer allein / retractor only  
 ecarteur seul / separador solamente /  
 Divaricatore solo

Valven für CASPAR Sperrer  
 Blades for CASPAR retractors  
 Valves pour écarteurs CASPAR  
 Valvas para separadores CASPAR  
 Valve per divaricatore CASPAR



**CASPAR TITANIUM**

- 27.5122 40 x 25 mm
- 27.5123 45 x 25 mm
- 27.5124 50 x 25 mm
- 27.5125 55 x 25 mm
- 27.5126 60 x 25 mm

MEDIAL



**CASPAR**

- 27.5152 40 x 23 mm
- 27.5153 45 x 23 mm
- 27.5154 50 x 23 mm
- 27.5155 55 x 23 mm
- 27.5156 60 x 23 mm

LATERAL



**CASPAR**

- 27.5132 40 x 23 mm
- 27.5133 45 x 23 mm
- 27.5134 50 x 23 mm
- 27.5135 55 x 23 mm
- 27.5136 60 x 23 mm

MEDIAL



**CASPAR**

- 27.5164 50 x 25 mm
- 27.5166 60 x 25 mm



**CASPAR TITANIUM**

- 27.5142 40 x 25 mm
- 27.5143 45 x 25 mm
- 27.5144 50 x 25 mm
- 27.5145 55 x 25 mm
- 27.5146 60 x 25 mm

LATERAL



**CASPAR**

- 27.5183 45 x 23 mm
- 27.5184 50 x 23 mm
- 27.5185 55 x 23 mm
- 27.5186 60 x 23 mm
- 27.5187 65 x 23 mm



**CASPAR**

- 27.5199
- Pinzette zum Blattwechsel
- Forceps for changing valves
- Pince pour changer les valves
- Pinza para cambiari valvas
- Pinza per cambiare valve



27.5401 45 mm  
 27.5402 50 mm  
 27.5403 55 mm  
 27.5404 60 mm  
 27.5405 65 mm



modifiziertes Model  
 improved model  
 modèle modifié  
 modelo modificado  
 modello modifìc.

**CASPAR**  
 27.5401 - 27.5405



**CASPAR**  
 27.5440

Gegensperrerr komplett bestehend aus:  
 27.5441 Gegensperrerr  
 27.5430 - 27.5435 6 Valven 35, 40, 45, 50, 55, 60 mm

Counter-Retractor complete, consisting of:  
 27.5441 Counter Retractor  
 27.5430 - 27.5435 6 Blades 35, 40, 45, 50, 55, 60 mm

Contre-Ecarteur complet, comprenant:  
 27.5441 Contre-Écarteur  
 27.5430 - 27.5435 6 valves 35, 40, 45, 50, 55, 60 mm

Contra-Separador completo, compuesto de:  
 27.5441 Contra-separador  
 27.5430 - 27.5435 6 valvas 35, 40, 45, 50, 55, 60 mm

Contra-Divaricatore completo, composta da:  
 27.5441 Contre-divaricatore  
 27.5430 - 27.5435 6 valve 35, 40, 45, 50, 55, 60 mm

**CASPAR**  
 27.5441

Gegensperrerr alleine / Counter-Retractor only  
 Contre-Ecarteur seul / Contra-Separador suelto  
 Contra-Divaricatore solo



**CASPAR**



**27.5030** 45 mm



**27.5031** 50 mm



**27.5032** 55 mm



**27.5033** 60 mm



**27.5034** 65 mm



**CASPAR**

**27.5420**

Sperrer komplett mit 6 Valven 27.5430 - 27.5435  
 Retractor complete with 6 blades 27.5430 - 27.5435  
 Ecarteur complet avec 6 valves 27.5430 - 27.5435  
 Separador completo con 6 valvas 27.5430 - 27.5435  
 Divaricatore completo con 6 valve 27.5430 - 27.5435

**27.5421**

Sperrer allein / retractor only  
 ecarteur seul / separador solamente / divaricatore solo

**27.5430** 35 mm



**27.5431** 40 mm



**27.5432** 45 mm



**27.5433** 50 mm



**27.5434** 55 mm



**27.5435** 60 mm



**27.5436** 65 mm



**27.5437** 75 mm



**27.5438** 85 mm







## CASPAR

### 27.5500

Wirbelkörperdistraktor für Operationen an unterer und mittlerer Halswirbelsäule von rechts, bestehend aus:

- 27.5501 Distraktor
- 27.5509 Bohrlehre rechts
- 27.5520 Bohrer
- 27.5536 Distraktionsschrauben 16 mm ( 2 St.)
- 27.5550 Schraubendreher

Vertebral body distractor for surgical procedures of the cervical spine, from the right, consisting of:

- 27.5501 Distractor
- 27.5509 Drillguide, right
- 27.5520 Twist Drill
- 27.5536 Distraction screws 16 mm ( 2 pcs.)
- 27.5550 Screwdriver

Distracteur des corps vertébraux pour la chirurgie de la colonne cervicale, accès du côté droite, comprenant:

- 27.5501 Distracteur
- 27.5509 Guide-forets, droite
- 27.5520 Foret
- 27.5536 Vis à distraction 16 mm ( 2 pcs.)
- 27.5550 Tourne-vis

Distractor de los cuerpos vertebrales para la cirugía de la columna cervical, acceso del lado derecho, compuesto de:

- 27.5501 Distractor
- 27.5509 Guia para brocas, a la derecha
- 27.5520 Perforador
- 27.5536 Tornillos para distracción 16 mm ( 2 pzas.)
- 27.5550 Destornillador

Distrattore die corpi vertebrali per la chirurgia della colonna cervicale, acceso del lato destro, composta da:

- 27.5501 Distrattore
- 27.5509 Guide di perforatori, destra
- 27.5520 Perforatore
- 27.5536 Viti di distrazione 16 mm ( 2 pezzi)
- 27.5550 Cacciavite

### 27.5501

Distraktor alleine / Distractor only / Distracteur seul / Distractor suelto / Distrattore solo



### 27.5509

Bohrlehre, links für 27.5500  
Drill Guide, left for 27.5500  
Guide-forets, gauche pour 27.5500  
Guia para brocas, a la izquierda para 27.5500  
Guide di perforatori, sinistra - per 27.5500



**27.5519**

Bohrlehre, rechts für 27.5510  
Drill Guide, right for 27.5510  
Guide-forets, droite pour 27.5510  
Guia para brocas, a la derecha para 27.5510  
Guide di perforatori, destra - per 27.5510



**CASPAR**

**27.5510**

Wirbelkörperdistraktor für Operationen an unterer und mittlerer Halswirbelsäule von links, bestehend aus:

- 27.5511 Distraktor
- 28.5519 Bohrlehre links
- 27.5520 Bohrer
- 27.5536 Distraktionsschrauben 16 mm ( 2 St.)
- 27.5500 Schraubendreher

Vertebral body distractor for surgical procedures of the cervical spine, from the left, consisting of:

- 27.5511 Distractor
- 28.5519 Drillguide, right
- 27.5520 Twist Drill
- 27.5536 Distraction screws 16 mm ( 2 pcs.)
- 27.5500 Screwdriver

Distracteur des corps vertébraux pour la chirurgie de la colonne cervicale, accès du côté gauche, comprenant:

- 27.5511 Distracteur
- 28.5519 Guide-forets, gauche
- 27.5520 Foret
- 27.5536 Vis à distraction 16 mm ( 2 pcs.)
- 27.5500 Tourne-vis

Distractor de los cuerpos vertebrales para la cirugía de la columna cervical, acceso del lado izquierdo, compuesto de:

- 27.5511 Distractor
- 28.5519 Guia para brocas, a la izquierda
- 27.5520 Perforador
- 27.5536 Tornillos para distracción 16 mm ( 2 pzas.)
- 27.5500 Destornillador

Distrattore die corpi vertebrali per la chirurgia della colonna cervicale, acceso del lato sinistro, composta da:

- 27.5511 Distrattore
- 28.5519 Guide di perforatori, sinistra
- 27.5520 Perforatore
- 27.5536 Viti di distrazione 16 mm ( 2 pezzi)
- 27.5500 Cacciavite

**27.5511**

Distraktor alleine / Distractor only / Distracteur seul /  
Distractor suelto / Distrattore solo



Bohrer  
Drill  
Mèche  
Broca  
Perforatore

**CASPAR**  
**27.5520**  
14,5 cm / 1,7 mm



Distraktionsschraube  
Distraction screw  
Vis à distraction  
Tornillo para distracción  
Viti di distrazione

**CASPAR**  
**27.5532** 12 mm  
**27.5534** 14 mm  
**27.5536** 16 mm  
**27.5538** 18 mm



Schraubenzieher  
Screwdriver  
Tourne-vis  
Destornillador  
Giravite

**CASPAR**  
**27.5550** 20 cm



**27.0700**

LEYLA Retraktor Set 1-Arm  
LEYLA Retractor Set 1-arm  
LEYLA Ecarteur Jue 1-bras  
LEYLA Separador Juego 1-brazo  
LEYLA Divaricatore Set 1-braccio

bestehend aus:

27.0705 flexibler Spannarm  
27.0706 Fixiervorrichtung für 1 Spannarm  
27.0709 Spatelhalterung für flache Spateln

consisting of:

27.0705 flexible arm  
27.0706 fixation base for 1 flexible arm  
27.0709 support for flat spatulas

comprenant:

27.0705 bras tendeur flexibles  
27.0706 étau crânien pour 1 bras flexible  
27.0709 porte-spatules plates

compuesto de:

27.0705 brazo flexible  
27.0706 dispositivo a fijación 1 brazo flexible  
27.0709 soporte para espátulas llanas

composto da:

27.0705 braccio flessibile solo  
27.0706 Fissatore per 1 braccio al cranio  
27.0709 Sostegno per spatole piatte

**27.0701**

LEYLA Retraktor 2-Arme  
LEYLA Retractor Set 2-arms  
LEYLA Ecarteur Jue 2-bras  
LEYLA Separador Juego 2-brazos  
LEYLA Divaricatore Set 2-bracci

bestehend aus:

27.0705 2 flexible Spannarme  
27.0707 1 Fixiervorrichtung für 2 Spannarme  
27.0709 2 Spatelhalterungen für flache Spateln

consisting of:

27.0705 2 flexible arms  
27.0707 1 fixation base for 2 flexible arms  
27.0709 2 supports for flat spatulas

comprenant:

27.0705 2 bras tendeur flexibles  
27.0707 1 étau crânien pour 2 bras flexibles  
27.0709 2 portes-spatules plates

compuesto de:

27.0705 2 brazos flexibles  
27.0707 1 dispositivo a fijación 2 brazos flexibles  
27.0709 2 soportes para espátulas llanas

composto da:

27.0705 2 bracci flessibili  
27.0707 1 Fissatore per bracci flessibili al cranio  
27.0709 2 Sostegni per spatole piatte



## 27.0702

LEYLA Retraktor System zum Fixieren am OP-Tisch

LEYLA Retractor System for fixation to Operating table

LEYLA Ecarteur Système pour attacher à la table d'opération

LEYLA Separador Sistema para fijar sobre la mesa de operaciones

LEYLA Divaricatore Sistema per fissare all' tavolo operatorio

bestehend aus:

27.0705 LEYLA Spannarm allein

27.0709 LEYLA Flachspatelhalter

27.0711 LEYLA Haltearm starr

27.0712 LEYLA Kupplungskopf zur Aufnahme von  
1 - 5 Spannarmen

27.0713 LEYLA Kugelgelenkkloben zum Befestigen  
des Haltearms am OP-Tisch

27.1031 HIRNSPATEL 200 / 9 mm

27.1032 HIRNSPATEL 200 / 12 mm

consisting of:

27.0705 LEYLA flexible arm only

27.0709 LEYLA Support f. flat Spatulas

27.0711 LEYLA Holding Rod rigid

27.0712 LEYLA coupling head for 1 - 5 flexible arms

27.0713 LEYLA Ball-and -socket joint for attaching  
Rod to operating table

27.1031 BRAIN SPATULA 200 / 9 mm

27.1032 BRAIN SPATULA 200 / 12 mm

comprenant:

27.0705 LEYLA bras tendeur flexible

27.0709 LEYLA porte-spatule pour spatules plats

27.0711 LEYLA potence, rigide

27.0712 LEYLA tete porte-bras pour 1 - 5 bras tendeur

27.0713 LEYLA Pièce de fixation pour attacher le bras  
à la table d'opération

27.1031 SPATULE cérébrale 200 / 9 mm

27.1032 SPATULE cérébrale 200 / 12 mm

compuesto de:

27.0705 LEYLA brazo flexible

27.0709 LEYLA porta-espátulas para espátulas planos

27.0711 LEYLA brazo rigido

27.0712 LEYLA cabeza porta-brazos para 1 - 5 brazos  
flexibles

27.0713 LEYLA Mecanismo para fijar el brazo  
sobre la mesa de operaciones

27.1031 ESPATULA cerebrale 200 / 9 mm

27.1032 ESPATULA cerebrale 200 / 12 mm

composto da:

27.0705 LEYLA braccio flessibile

27.0709 LEYLA Sostegno per spatole piatte

27.0711 LEYLA Braccio di fissaggio

27.0712 LEYLA Pezzo al combinare 1 - 5 bracci

27.0713 LEYLA Meccanismo per fissare il braccio  
all' tavolo operatorio

27.1031 SPATOLA cerebrale 200 / 9 mm

27.1032 SPATOLA cerebrale 200 / 12 mm

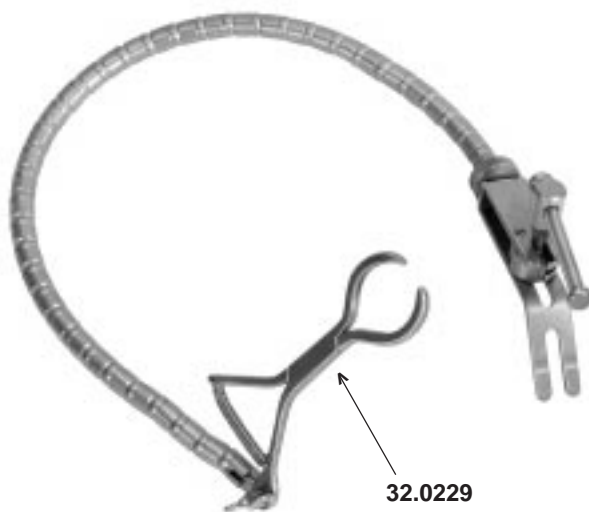

**32.0220**

LEYLA Ohrspekulahalter komplett

LEYLA Ear specula holder complete

LEYLA tendeur de spéculums auriculaires

LEYLA porta-especulos auriculares compl.

LEYLA Portaspecoli auricolari completo

**32.0229**

Ohrtrichterhalter

Ear specula holder

Tendeur de spéculums

Porta-especulos auriculares

Pinza portaspecoli auricolari

bestehend aus:

27.0705 LEYLA Spannarm allein

27.0708 LEYLA Fixiervorrichtung für Rohrteile

32.0229 LEYLA Ohrstrichterhalter

consisting of:

27.0705 LEYLA flexible arm only

27.0708 LEYLA Fixation base for mounting to bars

32.0229 LEYLA Ear specula holder

comprenant:

27.0705 LEYLA bras tendeur flexible

27.0708 LEYLA etau cranien simple pour attacher à potence etc.

32.0229 LEYLA Tendeur de spéculums

compuesto de:

27.0705 LEYLA brazo flexible

27.0708 LEYLA dispositivo a fijajion al brazo rigido

32.0229 LEYLA Porta-especulos auriculares

composto da:

27.0705 LEYLA braccio flessibile

27.0708 LEYLA Fissatore per 1 braccio al braccio

32.0229 LEYLA Pinza portaspecoli

27.0705

LEYLA Spannarm  
flexible arm  
Bras tendeur flexible  
Brazo flexible  
Braccio flessibile



27.0706

LEYLA Fixiervorrichtung für 1 Spannarm  
fixation base for 1 flexible arm  
étau crânien pour 1 bras flexible  
dispositivo a fijación 1 brazo flexible  
Fissatore per 1 braccio al cranio



27.0707

LEYLA Fixiervorrichtung für 2 Spannarme  
fixation base for 2 flexible arms  
étau crânien pour 2 bras flexibles  
dispositivo a fijación 2 brazos flexibles  
Fissatore per 2 bracci al cranio



27.0708

Fixiervorrichtung für 1 Spannarm 27.0705 zum Befestigen an Rohrteilen  
Fixation base for 1 flexible arm 27.0205 for attaching to round bars  
Pièce de fixation pour 1 bras 27.0205 aux tiges rondes  
Fijador para 1 brazo 27.0705 para fijar al tubos  
Fissatore per 1 braccio 27.0705 per il fissare al bracci rotondo



27.0709

LEYLA Flachspatelhalter  
support for flat spatulas  
porte-spatules plates  
soporte para espátulas llanas  
Sostegno per spatole piatte



27.0710

LEYLA Rundspatelhalter  
support for round spatulas  
porte-spatules pour spatules ronds  
porta-espátulas para espátulas rondos  
Sostegno per spatole con asta rotonda



- 27.0711** LEYLA Haltearm starr  
Holding Rod rigid  
Potence, rigide  
Brazo rigido  
Braccio rigido



- 27.0712** Kupplungskopf zur Aufnahme von 1 - 5 Spannarmen 27.0705  
Coupling head for 1-5 flexible arms 27.0705  
tête porte-bras pour 1 - 5 bras tendeur 27.0705  
cabeza porta-brazos para 1-5 brazos flexibles 27.0705  
Pezzo al combinare 1 - 5 bracci 27.0705



- 27.0713** Kugelgelenkkolben zum Befestigen des Haltearms 27.0711 am OP-Tisch  
Ball-and -socket joint for attaching Rod 27.0711 to operating table  
Pièce de fixation pour attacher le bras 27.0711 à la table d'opération  
Mecanismo para fijar el brazo 27.0711 sobre la mesa de operaciones  
Meccanismo per fissare il braccio 27.0711 all' tavolo operatorio





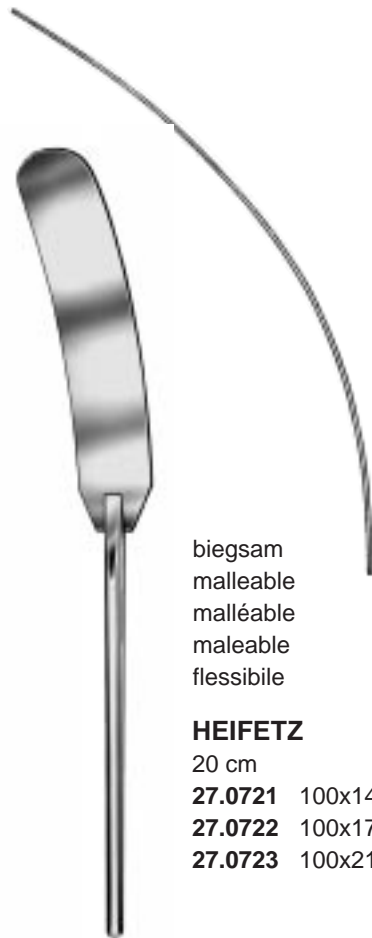

biegsam  
 malleable  
 malléable  
 maleable  
 flessibile

**HEIFETZ**

20 cm

- 27.0721** 100x14 mm
- 27.0722** 100x17 mm
- 27.0723** 100x21 mm

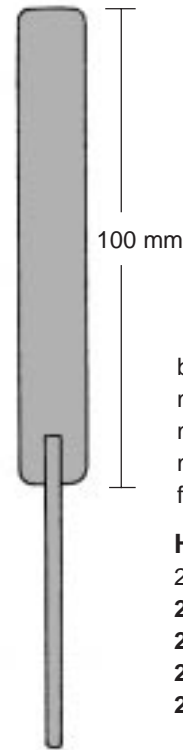

100 mm

biegsam  
 malleable  
 malléable  
 maleable  
 flessibile

**HEIFETZ**

20 cm

- 27.1026** 8 mm
- 27.1027** 11 mm
- 27.1028** 14 mm
- 27.1029** 17 mm



**"AACHEN"**

20 cm

- 27.1041** 7/ 8 mm
- 27.1042** 10/11 mm
- 27.1043** 13/14 mm
- 27.1044** 16/17 mm
- 27.1045** 19/20 mm
- 27.1046** 22/25 mm



**DAVIS**

18 cm

- 27.1050** 6,0 mm
- 27.1051** 9,5 mm
- 27.1052** 13,5 mm
- 27.1053** 16,0 mm
- 27.1054** 19,0 mm
- 27.1055** 25,0 mm
- 27.1056** 32,0 mm
- 27.1057** 38,0 mm



**SCOVILLE**

20 cm

- 27.1060** 10/13 mm
- 27.1061** 16/19 mm

biegsam / malleable / malléable / maleable / flessibile



**27.1031** 200 x 9 mm  
**27.1032** 200 x 12 mm  
**27.1033** 250 x 12 mm

biegsam  
 malleable  
 malléable  
 maleable  
 flessibile



**27.1034** "MEMORY" 200 x 9 mm  
**27.1035** "MEMORY" 200 x 12 mm  
**27.1036** "MEMORY" 200 x 14 mm  
**27.1037** "MEMORY" 200 x 18 mm  
**27.1038** "MEMORY" 200 x 20 mm  
**27.1039** "MEMORY" 200 x 25 mm

biegsame "MEMORY"-Legierung  
 malleable "MEMORY" alloy  
 alliage flexible "MEMORY"  
 aleación flexible "MEMORY"  
 lega flessibile "MEMORY"



**OLIVECRONA**

konkav / concave  
 concave / cóncavas  
 concave

18 cm

**27.1000** 7 x 9 mm  
**27.1001** 11 x 13 mm  
**27.1002** 15 x 18 mm  
**27.1003** 18 x 22 mm



**OLIVECRONA**

konvex / convex  
 convexe / convexas  
 convesse

18 cm

**27.1005** 7 x 9 mm  
**27.1006** 11 x 13 mm  
**27.1007** 15 x 18 mm  
**27.1008** 18 x 22 mm



**CUSHING**

**27.1010**

17 cm 8 x 10 mm

**27.1012**

20 cm 13 x 15 mm



40.0670

a	b	c	d
55 mm	100 mm	170 mm	130 mm

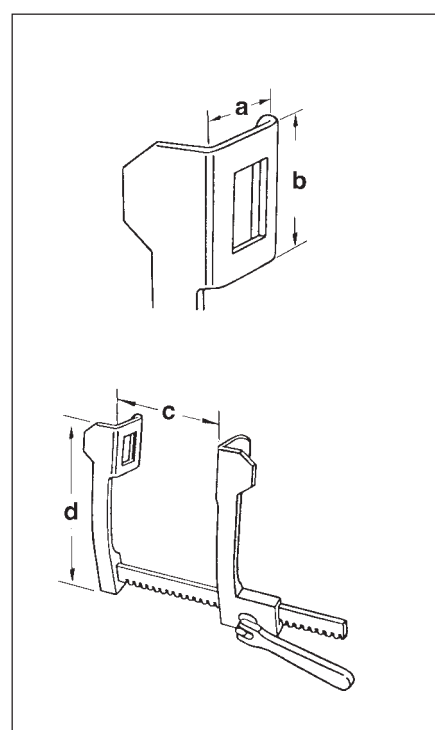



90x15 mm

**MATHIEU**  
**48.1030**  
 19,5 cm

**ALAN-PARKS**

**48.1050** 15 cm  
 komplett  
 complete  
 complet  
 completo

**48.1051**  
 Sperrer allein  
 retractor only  
 ecarteur seul  
 separador solamente  
 divaricatore solo

**48.1054**  
 95x24 mm  
 Mittelvalve alleine  
 Center blade only  
 Valve centrale aeul  
 Valva central solomenta  
 Valva centrale solo



**48.1052**  
 75 x 24 mm



**48.1053**  
 95 x 24 mm



75 x 23 mm

**SMITH-BUIE**  
48.1060 15 cm



70 x 22 mm

**BARR**  
48.1070 17 cm



**ST. MARKS**  
48.1080 22 cm



**MILLIN**  
**51.0020**  
28 cm



**MILLIN**  
**51.0080**

komplett, mit 2 Seitenvalven 57x25 mm und 80x25 mm, 1 Mittelvale 120x45 mm  
complete, with 2 lateral valves 57x25 mm and 80x25 mm, 1 center blade 120x45 mm  
complet, avec 2 valves latérales 57x25 mm et 80x25 mm, 1 valve centrale 120x45 mm  
completo, con 2 valvas laterales 57x25 mm y 80x25 mm, 1 valva central 120x45 mm  
completo, con 2 valve laterali 57x25 mm e 80x25 mm, 1 valva centrale 120x45 mm



**JUDD-MASSON**  
**51.0070**

Spreizweite 100 mm  
spread 100 mm  
ouverture 100 mm  
apertura 100 mm  
apertura 100 mm



**JUDD-MASSON**  
**51.0072**

komplett, mit 2 Seitenvalven 70x25 mm und 1 Mittelvalve 84x24 mm  
 complete, with 2 lateral valves 70x25 mm and 1 center blade 84x24 mm  
 complet, avec 2 valves latérales 70x25 mm et 1 valve centrale 84x24 mm  
 completo, con 2 valvas laterales 70x25 mm y 1 valva central 84x24 mm  
 completo, con 2 valve laterali 70x25 mm e 1 valva centrale 84x24 mm



**THOMSON-WALKER**  
**51.0090**

komplett, mit 2 Seitenvalven 70x25 mm und 75x25 mm, 1 Mittelvalve 90x25 mm  
 complete, with 2 lateral valves 70x25 mm and 75x25 mm, 1 center blade 90x25 mm  
 complet, avec 2 valves latérales 70x25 mm et 75x25 mm, 1 valve centrale 90x25 mm  
 completo, con 2 valvas laterales 70x25 mm y 75x25 mm, 1 valva central 90x25 mm  
 completo, con 2 valve laterali 70x25 mm e 75x25 mm, 1 valva centrale 90x25 mm



**HRYNTSCHAK**  
**51.0098**

Rahmen allein  
 Frame only  
 Cadre seul  
 Bastidor solo  
 Telaio solo

**HRYNTSCHAK**  
**51.0099**

Mittelvalve 35x100mm  
 Center blade 35x100mm  
 Valve centrale 35x100mm  
 Valva central 35x100mm  
 Valva centrale 35x100mm

**HRYNTSCHAK**  
**51.0097**

Spreizweite 110 mm  
 spread 110 mm  
 ouverture 110 mm  
 apertura 110 mm  
 apertura 110 mm



**KOGAN**  
55.0530 24 cm



**KOGAN**  
55.0532 24 cm



**LATERAL**  
55.0550  
22 cm





