

STERILISATION  
STERILIZATION  
STERILISATION  
ESTERILIZACION  
STERILIZZAZIONE

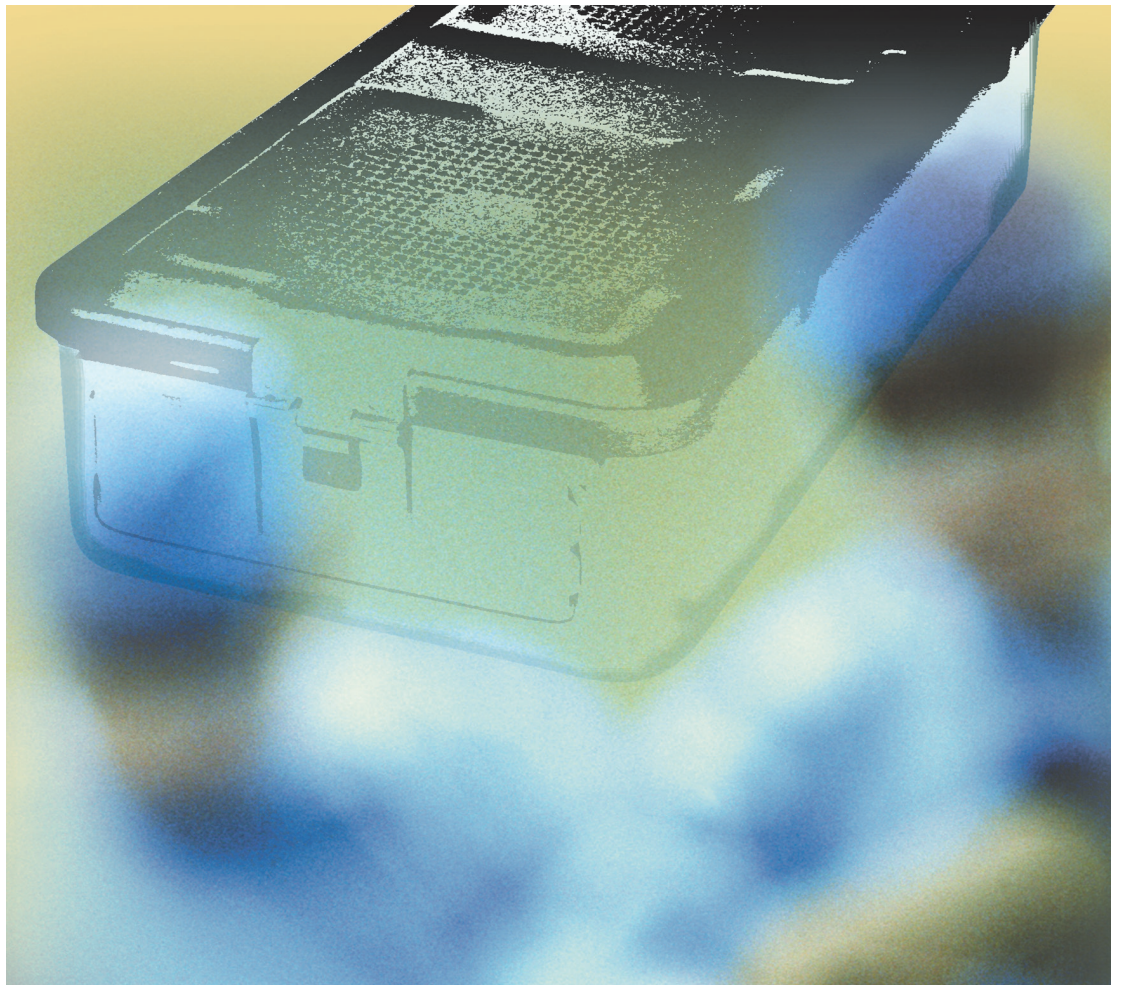

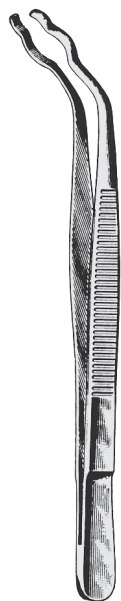

**DAVIS**  
 16.1000 16 cm  
 16.1002 20 cm  
 16.1004 25 cm

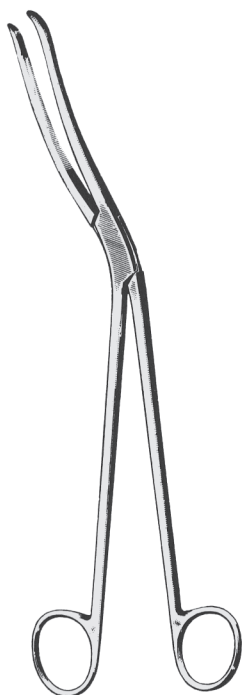

**CHEATLE**  
 16.1010 27 cm

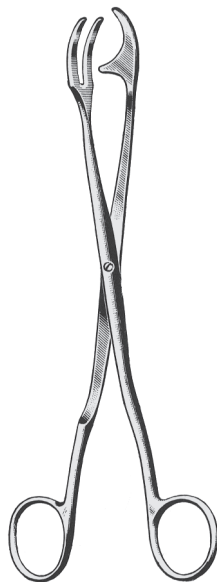

**ROGGE**  
 16.1020 23 cm

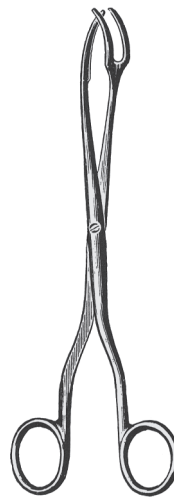

**STERILIZING**  
 16.1030 20 cm  
 16.1032 30 cm

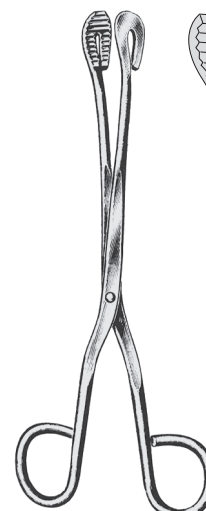

**STERILIZING**  
 16.1040 20 cm  
 16.1042 28 cm

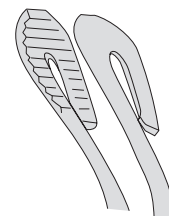

16.1041 20 cm  
 16.1043 28 cm

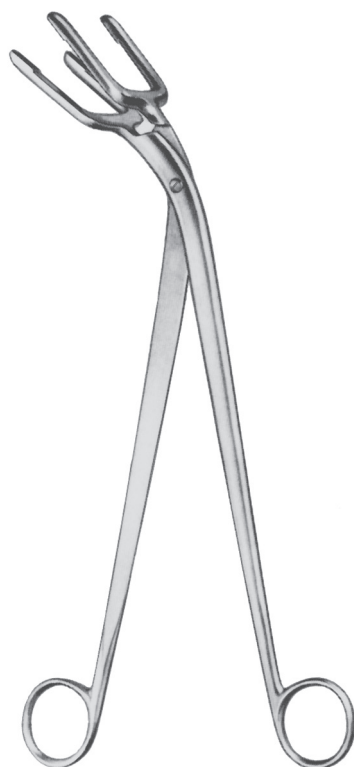

**HARRISON**  
 16.1050 25 cm  
 16.1052 30 cm

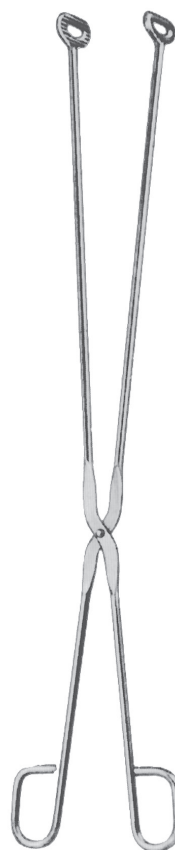

**MARTIN**  
 16.1060 58 cm



**SAUERBRUCH**  
 16.1070 55 cm



**BUNT**  
 16.1100  
 12 cm



**MAYO**  
 16.1110  
 14 cm



**MAYO**  
 16.1115  
 14 cm



**STRINGER**

- 16.1150 10 x 7 cm
- 16.1152 15 x 7 cm
- 16.1153 20 x 7 cm
- 16.1154 25 x 7 cm
- 16.1155 30 x 7 cm
- 16.1156 35 x 7 cm
- 16.1157 40 x 7 cm
- 16.1158 45 x 9 cm
- 16.1159 50 x 9 cm



**16.1500**

Infusionsflaschen-Öffnungszange  
 Infusion-bottle Opening Forceps  
 Pince pour ouvrir les bouteilles d'infusion  
 Pinza para abrir botellas de infusión  
 Pinza apri flebo

# 1/2 Container, ALU

Deckel gelocht und farbig  
 Lid perforated and colored  
 Couvercle perforé et coloré  
 Tapas perforadas y coloreados  
 Coperchio perforato e colorato



**L x B x H mm**

285x280x100	80.6001	80.6002	80.6003	80.6004	80.6005	80.6006
285x280x135	80.6011	80.6012	80.6013	80.6014	80.6015	80.6016
285x280x150	80.6021	80.6022	80.6023	80.6024	80.6025	80.6026
285x280x200	80.6031	80.6032	80.6033	80.6034	80.6035	80.6036
285x280x260	80.6041	80.6042	80.6043	80.6044	80.6045	80.6046



## Zubehör · Accessories · Accessoires · Accesorios · Accessori

für  
1/2 Container

for  
1/2 Containers

pour  
1/2 Containers

para  
1/2 Contenedores

per  
1/2 Contenitori



**Siebkörbe**  
**Wire baskets**  
**Plateaux inox**  
**Bandejas inoxidable**  
**Cestelli in acciaio fino**

80.6203 255x245x 30 mm

80.6205 255x245x 50 mm

80.6207 255x245x 70 mm

80.6210 255x245x100 mm

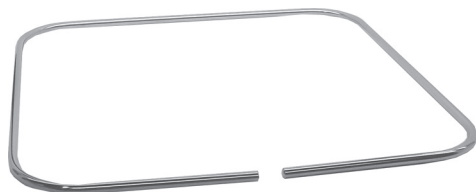

**Spannrahmen**  
**Cloth fixing frames**  
**Cadres fixe-toile**  
**Cuadros para fijar panos**  
**Telai fissateli**

80.6231 255x255 mm

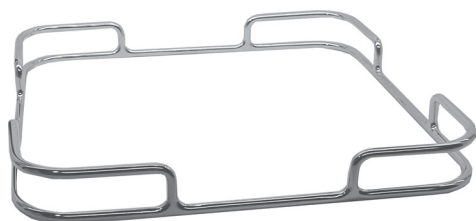

80.6232 255x255x30 mm



**Teiler**  
**Deviders**  
**Cloisons**  
**Tabiques**  
**Divisori**

80.6240 255x245x130 mm

# 3/4 Container, ALU

Deckel gelocht und farbig  
 Lid perforated and colored  
 Couvercle perforé et coloré  
 Tapas perforadas y coloreados  
 Coperchio perforato e colorato



L x B x H mm

465x280x100	80.6301	80.6302	80.6303	80.6304	80.6305	80.6306
465x280x135	80.6311	80.6312	80.6313	80.6314	80.6315	80.6316
465x280x150	80.6321	80.6322	80.6323	80.6324	80.6325	80.6326

## Zubehör · Accessories · Accessoires · Accesorios · Accessori

für  
3/4 Container

for  
3/4 Containers

pour  
3/4 Containers

para  
3/4 Contenedores

per  
3/4 Contenitori

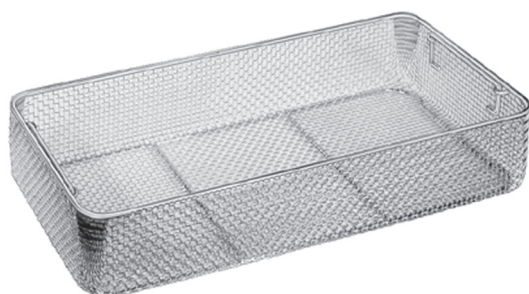

**Siebkörbe**  
**Wire baskets**  
**Plateaux inox**  
**Bandejas inoxidable**  
**Cestelli in acciaio fino**

80.6503	405x245x 30 mm
80.6505	405x245x 50 mm
80.6507	405x245x 70 mm
80.6510	405x245x100 mm



**Spannrahmen**  
**Cloth fixing frames**  
**Cadres fixe-toile**  
**Cuadros para fijar panos**  
**Telai fissateli**

80.6531	405x255 mm
---------	------------

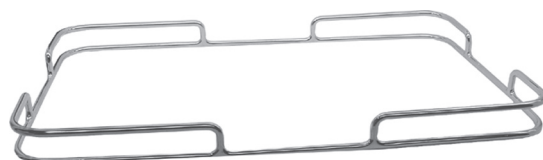

80.6532	405x255x30 mm
---------	---------------

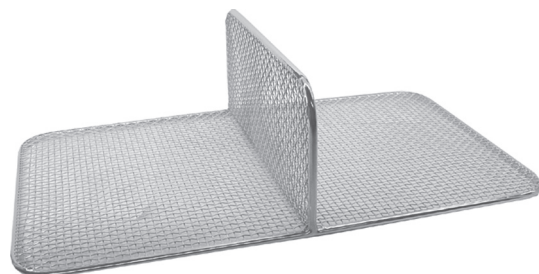

**Teiler**  
**Deviders**  
**Cloisons**  
**Tabiques**  
**Divisori**

80.6540	405x250x130 mm
---------	----------------



80.6541	405x250x130 mm
---------	----------------

# 1/1 Container, ALU

Deckel gelocht und farbig  
 Lid perforated and colored  
 Couvercle perforé et coloré  
 Tapas perforadas y coloreados  
 Coperchio perforato e colorato



L x B x H mm

580x280x100	80.6601	80.6602	80.6603	80.6604	80.6605	80.6606
580x280x135	80.6611	80.6612	80.6613	80.6614	80.6615	80.6616
580x280x150	80.6621	80.6622	80.6623	80.6624	80.6625	80.6626
580x280x200	80.6631	80.6632	80.6633	80.6634	80.6635	80.6636
580x280x260	80.6641	80.6642	80.6643	80.6644	80.6645	80.6646



## Zubehör · Accessories · Accessoires · Accesorios · Accessori

für  
1/1 Container

for  
1/1 Containers

pour  
1/1 Containers

para  
1/1 Contenedores

per  
1/1 Contenitori

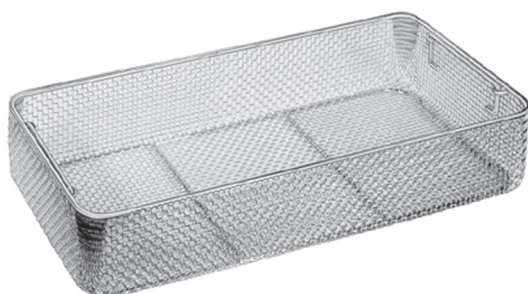

**Siebkörbe**  
**Wire baskets**  
**Plateaux inox**  
**Bandejas inoxidable**  
**Cestelli in acciaio fino**

80.6803	485x285x 30 mm
80.6805	485x285x 50 mm
80.6807	485x285x 70 mm
80.6810	485x285x100 mm
80.6813	540x285x 30 mm
80.6815	540x285x 50 mm
80.6817	540x285x 70 mm
80.6820	540x285x100 mm



**Spannrahmen**  
**Cloth fixing frames**  
**Cadres fixe-toile**  
**Cuadros para fijar panos**  
**Telai fissateli**

80.6841	545x245 mm
---------	------------

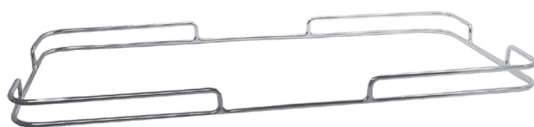

80.6842 5	45x245x30 mm
-----------	--------------

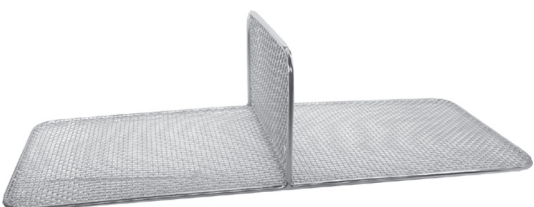

**Teiler**  
**Deviders**  
**Cloisons**  
**Tabiques**  
**Divisori**

80.6850	510x250x130 mm
---------	----------------

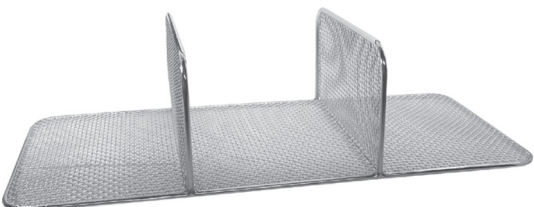

80.6851	510x250x130 mm
---------	----------------

# Flach- und Mini-Container, ALU eloxiert

Flat- and Mini-Containers, ALU

Containers plates et mini en aluminium

Contenedores planos y mini de aluminio

Contentori piatti e mini in alluminio



Deckel gelocht und farbig  
 Lid perforated and colored  
 Couvercle perforé et coloré  
 Tapas perforadas y coloreados  
 Coperchio perforato e colorato



Flach – Flat – Plat – Plano – Platto



L x B x H mm

285x280x55	80.7001	80.7002	80.7003	80.7004	80.7005	80.7006
285x280x85	80.7011	80.7012	80.7013	80.7014	80.7015	80.7016



Mini

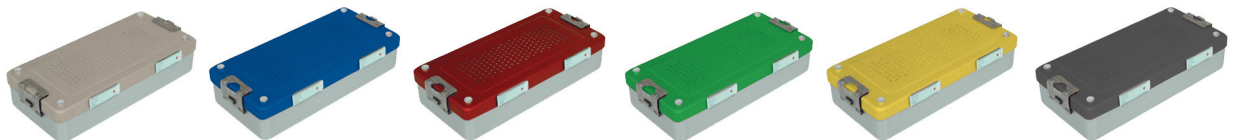

L x B x H mm

300x140x40	80.7301	80.7302	80.7303	80.7304	80.7305	80.7306
300x140x70	80.7311	80.7312	80.7313	80.7314	80.7315	80.7316
300x140x100	80.7321	80.7322	80.7323	80.7324	80.7325	80.7326

## Zubehör · Accessories · Accessoires · Accesorios · Accessori

für FLACH- und  
MINI-Container

for FLAT- and MI-  
NI-Containers

pour Containers  
PLARTS et MINI

para Contenedores  
PLANOS y MINI

per Contenitori  
PIATTI e MINI



**Siebkorb mit Deckel**  
**Wire basket with lid**  
**Panier avec couvercle**  
**Cestillo con cobertera**  
**Cestello con coperchio**

80.7410 267x125x50 mm



**Siebeinlage f. MINI-Container**  
**Separate base for MINI-Container**  
**Fond du crible pour MINI-Container**  
**Base para MINI-Container**  
**Base per MINI-Container**

80.7420 270x125 mm

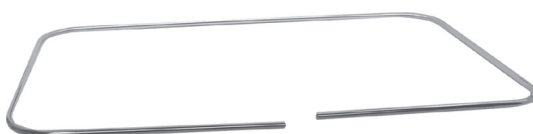

**Spannrahmen für Mini-Container**  
**Cloth fixing frames for MINI-Container**  
**Cadres fixe-toile pour MINI-Container**  
**Cuadros para fijar panos para MINI-Container**  
**Telai fissateli per MINI-Container**

80.7431 270x125 mm

# Endoskopie-Container, ALU eloxiert

Endoscopy-Containers, ALU

Containers a endoscopie en aluminium

Contenedores para endoscopiade aluminio

Contentitori per endoscopia in alluminio

Deckel gelocht und farbig

Lid perforated and colored

Couvercle perforé et coloré

Tapas perforadas y coloreados

Coperchio perforato e colorato

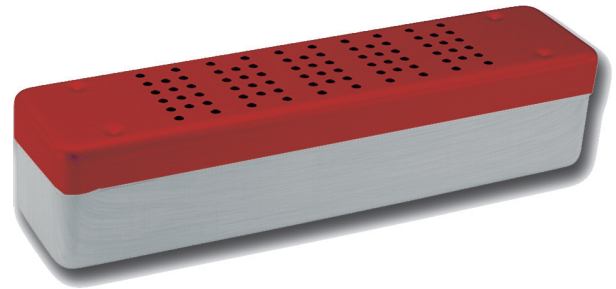

L x B x H mm

250x60x50

80.7501

80.7503

80.7504

450x70x70

80.7511

80.7513

80.7514

## Zubehör · Accessories · Accessoires · Accesorios · Accessori

Siebköbe Endoskopie

Wire baskets Endoscopy

Paniers Endoscopie

Cestillos Endoscopia

Cestilli Endoscopia

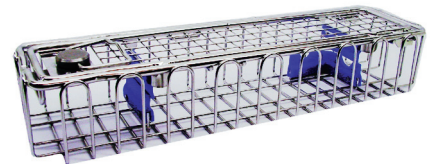
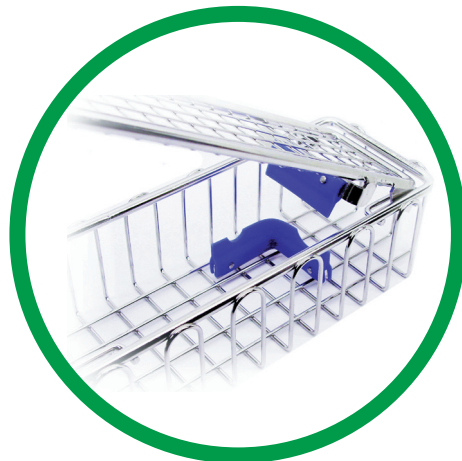

80.7551 290x 80x50 mm

80.7552 460x 80x50 mm

80.7553 640x150x77 mm



## Zubehör · Accessories · Accessoires · Accesorios · Accessori

Kennzeichnungsschilder, Aluminium ohne Text  
Identification labels, aluminium, neutral  
Plaquettes d'identificationen aluminium, neutres  
Placas de identificación, aluminio, neutral  
Targhette di identificazione d'alluminio, neutre



80.7901 80.7902 80.7903 80.7904 80.7905 80.7906

Kennzeichnungsschilder, Aluminium graviert  
Identification labels, aluminium, engraved  
Plaquettes d'identificationen aluminium, gravées  
Placas de identificación, aluminio, grabadas  
Targhette di identificazione d'alluminio, incise



80.7911 80.7912 80.7913 80.7914 80.7915 80.7916

Sortiermagazin für Kennzeichnungsschilder  
Rack for identification labels  
Magasin à plaquettes d'identification  
Cajita para seleccionar placas  
Cassetta da selezione targhette

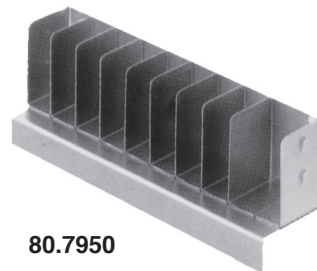

80.7950

Indikator-Schilder, Papier, 100 St.  
Indicating labels, paper, 100 pcs.  
Etiquettes d'identification en papier, les 100  
Etiquetas indicadoras, papel 100 c/u  
Targhette con indicatore, papel, 100 pezzi

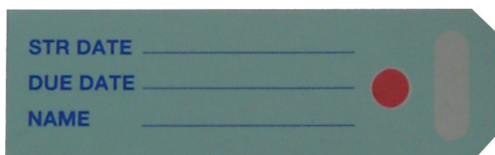

80.7960

klein / small / petite / pequenas / piccolo

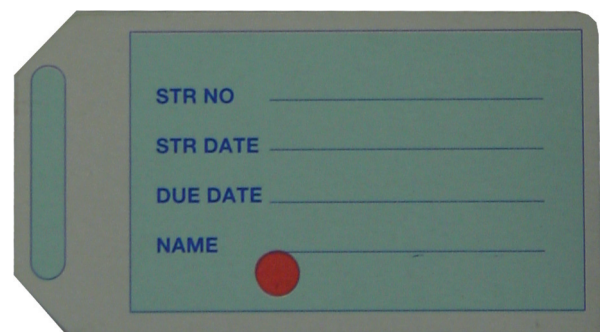

80.7962

groß / large / grande / grande / grande

Sicherungsplomben, Plastik, 100 St.  
Safety Seals, plastic, 100 pcs.  
Scellés de sécurité, plastique, les 100  
Precintos de seguridad,plastico 100 c/u  
Sigilli di sicurezza, plastica, 100 pezzi



80.7980

**Zubehör · Accessories · Accessoires · Accesorios · Accessori**

**Filterspender für 1/2, 3/4, 1/1 Container-Filter**  
**Filter Dispenser for 1/2, 3/4, 1/1 Container-Filters**  
**Présentoir de filtres pour les 1/2, 3/4, 1/1 Containers**  
**Distribuidor de filtros para los 1/2, 3/4, 1/1 Containers**  
**Distributore di filtri per 1/2, 3/4, 1/1 Container**

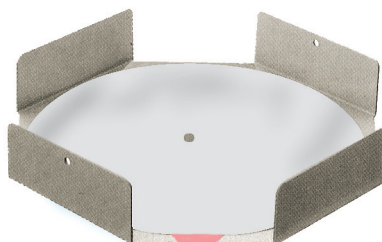

80.8000

**Filterhalter für 1/2, 3/4, 1/1 Container**  
**Filter Holder for 1/2, 3/4, 1/1 Containers**  
**Fixe-filtres pour 1/2, 3/4, 1/1 Containers**  
**Sujetafiltros para los 1/2, 3/4, 1/1 Containers**  
**Fermafiltro per 1/2, 3/4, 1/1 Container**



80.8010

**Filter, Einmalgebrauch, Papier 1000 St.**  
**Single use filters, paper 1000 pcs.**  
**Filtres en papier à usage unique, les 1000**  
**Filtros, monouso, papel, 1000 c/u**  
**Filtri, monouso, carta, 1000 pezzi**

**FILTER, Papier für 1/2, 3/4, 1/1 Container**  
**for 1/2, 3/4, 1/1 Containers**  
**pour 1/2, 3/4, 1/1 Containers**  
**para los 1/2, 3/4, 1/1 Containers**  
**per 1/2, 3/4, 1/1 Container**

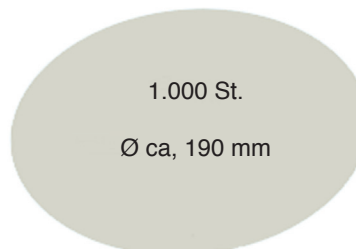

80.8050

**FILTER, Papier für MINI-Container**  
**for MINI-Containers**  
**pour MINI-Containers**  
**para MINI-Containers**  
**per MINI-Containers**



80.8052

**FILTER, Papier für DENTAL Container**  
**for DENTAL-Containers**  
**pour DENTAL-Containers**  
**para DENTAL-Containers**  
**per DENTAL-Containers**

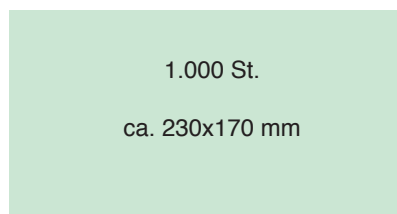

80.8054

## Zubehör · Accessories · Accessoires · Accesorios · Accessori

**Langzeit-Textilfilter, 1 St.**  
**Long-term textile filters, 1 pc.**  
**Filtres en textile, la pièce**  
**Filtros de textil, 1 c/u**  
**Filtri tessili, il pezzo**

FILTER, Textil für 1/2, 3/4, 1/1 Container  
for 1/2, 3/4, 1/1 Containers  
pour 1/2, 3/4, 1/1 Containers  
para los 1/2, 3/4, 1/1 Containers  
per 1/2, 3/4, 1/1 Container



80.8060

FILTER, Textil für MINI-Container  
for MINI-Containers  
pour MINI-Containers  
para MINI-Containers  
per MINI-Containers

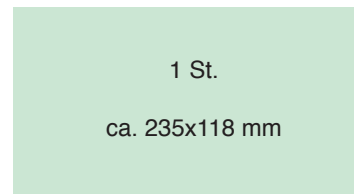

80.8062

FILTER, Textil für DENTAL Container  
for DENTAL-Containers  
pour DENTAL-Containers  
para DENTAL-Containers  
per DENTAL-Containers

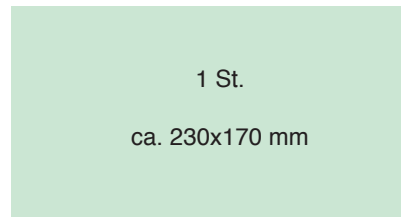

80.8064

**Sterilisier-Tücher, Baumwolle**  
**Sterilizing Drapes, cotton**  
**Champs à stérilisation, coton**  
**Paños de esterilización de algodón**  
**Pannos di sterilizzazione, cotone**

**80.8100** 40 x 60 cm  
**80.8105** 85 x 85 cm  
**80.8110** 100 x 140 cm  
**80.8115** 275 x 125 cm  
**80.8120** 245 x 245 cm



80.8100-  
80.8120

**Noppenmatten, Silikon**  
**Silicone Pads**  
**Tapis port-instruments, silicone**  
**Tapices porta instrumentos de silicona**  
**Tapetti porta-strumenti in silicone**

**80.8131** 275 x 125 mm  
**80.8132** 225 x 225 mm  
**80.8133** 300 x 300 mm

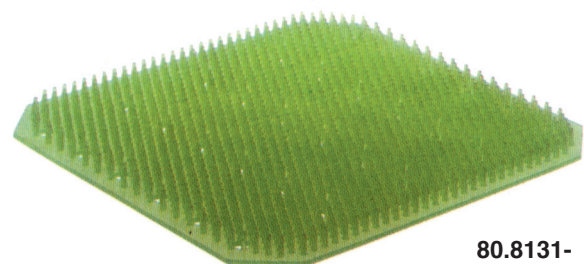

80.8131-  
80.8133

**Zubehör · Accessories · Accessoires · Accesorios · Accessori**

**Fixierklammern für Tücher**  
**Fixation Clamps for Drapes**  
**Pinces fixe-toiles**  
**Grapas para fijar paños**  
**Pinze di fillaggio per teli**

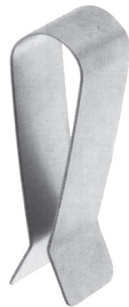

**80.8150**

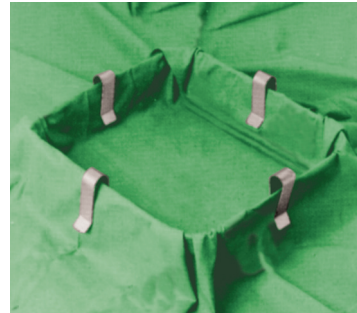

- 80.8160** Ø 7 - 12 mm
- 80.8161** Ø 12 - 16 mm
- 80.8162** Ø 16 - 26 mm
- 80.8163** Ø 26 - 36 mm
- 80.8164** Ø 36 - 45 mm

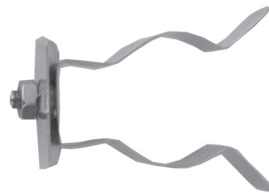

**80.8160-  
70.8164**

**Fixierfedern**  
**Spiral Supports**  
**Ressorts spiraux**  
**Apoyos con resorte spiral**  
**Supporte a molle**

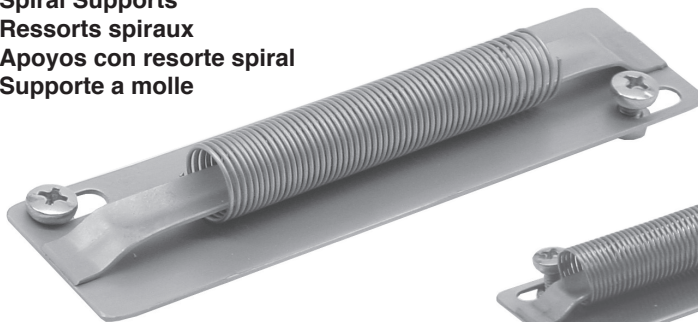

**80.8191** 115 x 30 mm



**80.8192** 230 x 30 mm

**80.8140 SILIKON Fixierstreifen Set**

bestehend aus:

80.8141 1 Silikon Streifen 246 x 13 mm

80.8142 2 Silikon Halteknöpfe

**SILICONE Storage Strip Set**

consisting of:

80.8141 1 Silicone Storage Strip 246x13 mm

80.8142 2 Silicone Fastening Knobs

**SILICONE bande porte instrum.** 243 x 13 mm

Jeu comprenant:

80.8141 1 Silicone bande à sécurité 243 x 13 mm

80.8142 2 Silicone boutons à fixation

**SILICONE tira de protección** 243 x 13 mm

Juego compuesto de:

80.8141 1 Silicone tira de protección 243 x 13 mm

80.8142 2 Silicone botones de fijar

**SILICONE strisce per assicurare** 243x13 mm

Set composto da:

80.8141 1 Silicone strisce per assicurare 243x13 mm

80.8142 2 Silicone botoni de fissare

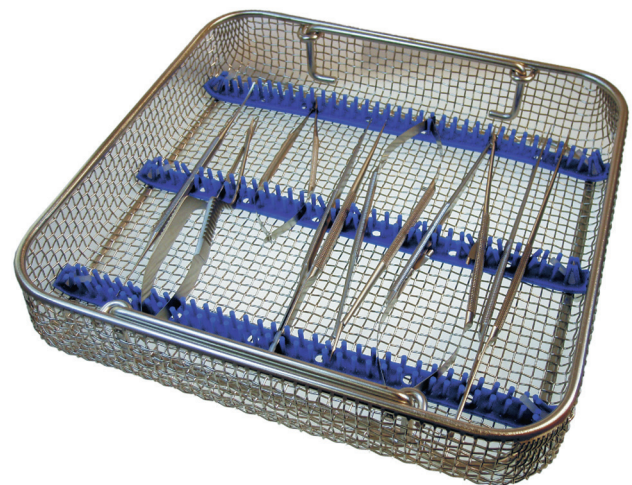

**80.8141** 246x13 mm



**80.8142** 2 Stück / 2 pieces / 2 pièces / 2 piezas / 2 pezzi



## Zubehör · Accessories · Accessoires · Accesorios · Accessori

**Haltestifte, Trennbleche**  
**Fixing bolts, Dividers**  
**Attaches de fixation, Séparateurs**  
**Piñons para fijar, Separadores**  
**Perne di fissaggio, Divisori**

Haltestift für Instrumente  
for instruments  
pour instruments  
para instrumentos  
per strumenti



80.8201

Haltestift für Trennbleche  
for Dividers  
pour Séparateurs  
para Separadores  
per Divisori



80.8202

**Trennbleche**  
**Dividers**  
**Séparateurs**  
**Separadores**  
**Divisori**

80.8211 50x20 mm  
80.8212 130x20 mm  
80.8213 225x20 mm  
80.8214 460x20 mm

**Winkelbleche**  
**Angled Dividers**  
**Séparateurs angulés**  
**Separadors angulados**  
**Divisori angulate**

80.8221 110 mm  
80.8222 170 mm  
80.8223 230 mm  
80.8223 470 mm

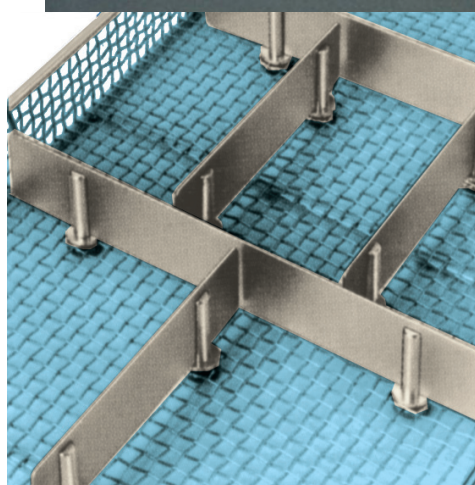
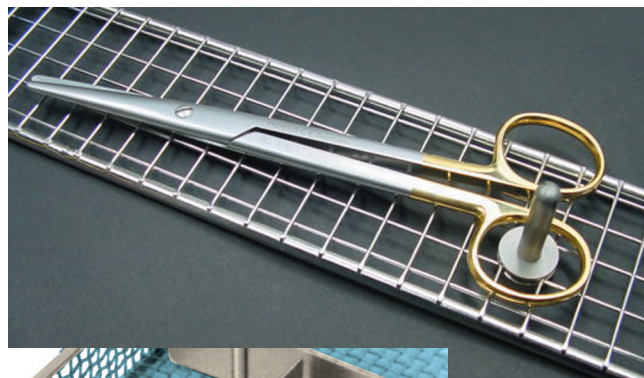

**Sterilisierahmen für 8 Mikro-Instrumente**  
**Sterilizing Rack for 8 Micro-Instruments**  
**Chevalet à Sterilisation pour 8 Micro-Instruments**  
**Porta-instrumentos para 8 Micro Instrumentos**  
**Telaio per sterilizzazione per 8 micro-strumenti**

80.3190 190 x 36 x 35 mm

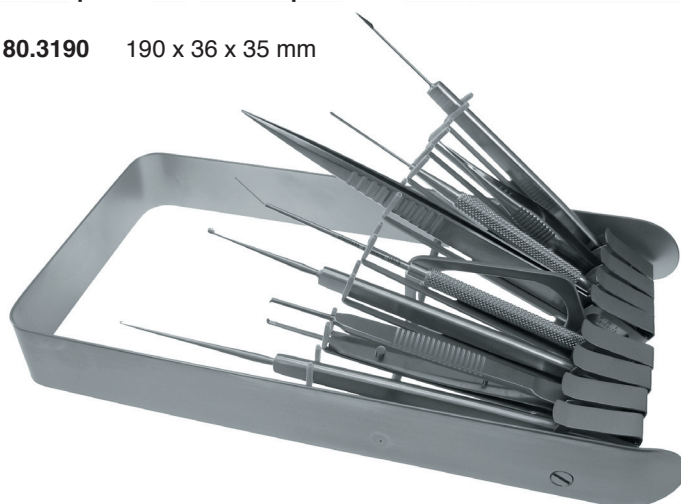

**Sterilisation · Sterilization · Sterilisation · Esterilizacion · Sterilizzazione**

Container für mikrochirurgische Instrumente  
 Containers for microsurgical instruments  
 Containers pour instruments de microchirurgie  
 Contenedores para instrumental microcirugia  
 Contenitori per strumenti per microchirurgia



**80.3112** 300x220x55 mm  
**80.3114** 285x280x55 mm  
**80.3116** 400x290x55 mm

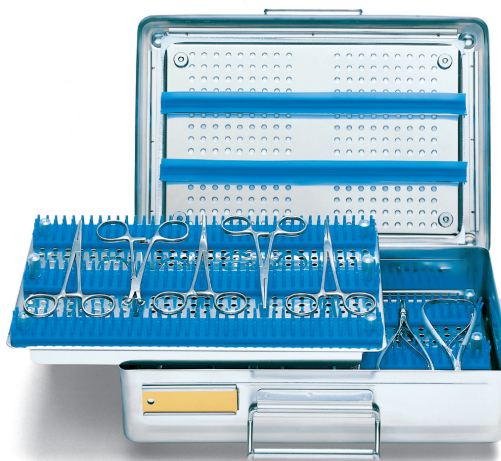

**80.3162** 300x220x75 mm  
**80.3164** 285x280x75 mm  
**80.3166** 400x290x75 mm

Sterilisiertrommeln  
 Sterilizing drums  
 Boites rondes à sterilisation  
 Tambores de esterilizacion  
 Cestelli rotondi per sterilizzazione

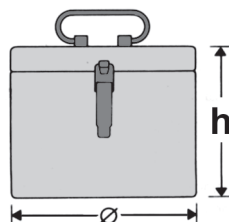

**SCHIMMELBUSCH**

<b>80.4002</b>	120x120 mm	<b>80.4016</b>	240x240 mm
<b>80.4004</b>	140x140 mm	<b>80.4018</b>	290x160 mm
<b>80.4006</b>	160x120 mm	<b>80.4020</b>	290x240 mm
<b>80.4008</b>	160x150 mm	<b>80.4022</b>	340x160 mm
<b>80.4010</b>	190x150 mm	<b>80.4024</b>	340x240 mm
<b>80.4012</b>	190x190 mm	<b>80.4026</b>	390x190 mm
<b>80.4014</b>	240x160 mm	<b>80.4028</b>	390x290 mm



**80.4002-  
80.4028**

**KONRICH**

<b>80.4040</b>	96 x 99 mm	<b>80.4054</b>	285 x 240 mm
<b>80.4042</b>	156 x 146 mm	<b>80.4056</b>	334 x 158 mm
<b>80.4044</b>	188 x 140 mm	<b>80.4058</b>	334 x 238 mm
<b>80.4046</b>	188 x 185 mm	<b>80.4060</b>	384 x 138 mm
<b>80.4048</b>	239 x 160 mm	<b>80.4062</b>	384 x 188 mm
<b>80.4050</b>	239 x 240 mm	<b>80.4064</b>	384 x 288mm
<b>80.4052</b>	285 x 160 mm		



**80.4040-  
80.4064**

## Zubehör · Accessories · Accessoires · Accesorios · Accessori

Pflegeöl für chirurgische Instrumente  
Lubricating Oil for Surgical Instruments  
Huile pour lubrifier les instruments chirurgicaux  
Lubrificante para las instrumentos quirúrgicos  
Olio per lubrificazione di strumenti chirurgici

80.0010 50 cc.  
80.0012 250 cc.  
80.0014 1000 cc.



80.0010

Wattspender  
Cotton dispensers  
Distributeurs de coton  
Dispensores de algodón  
Distributore del cotone

80.1000 75 x 50 Ø  
80.1002 115 x 75 Ø

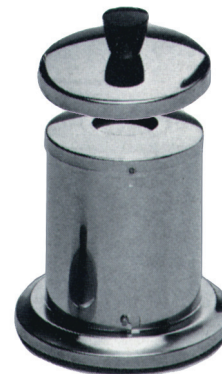

80.1000-  
80.1002

Watteabfallbehälter  
Cotton Waste Collector  
Poubelle pour coton  
Recipiente para algodón  
Recipiente per cotone usato

80.1010 75 x 50 Ø  
80.1012 100 x 75 Ø



80.1010-  
80.1012

Nadeldosen  
Needle Cases  
Boîtes à aiguilles  
Estuches para agujas  
Astucci per aghi

80.2000 65x17 mm  
komplett - complete - complet - completo - completo



80.2000

80.2009 Innendose allein für 80.2000  
insert only for 80.2000  
boîte int Érieure seulement pour 80.2000  
Caja interior suelta para 80.2000  
Scatola interna sola per 80.2000

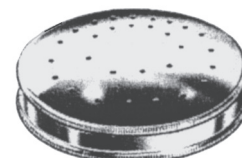

80.2009



**Zubehör · Accessories · Accessoires · Accesorios · Accessori**

**80.2020** 150x95x13 mm



**80.2020**

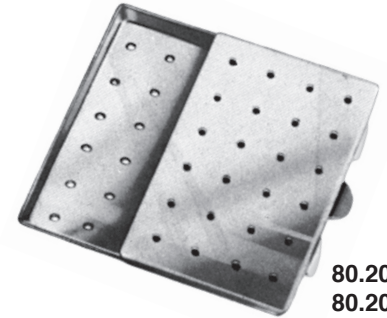

**80.2030-  
80.2032**

**80.2030** 50x25x4,5 mm

**80.2031** 65x42x8,0 mm

**80.2032** 75x25x4,5 mm

**SAUERBRUCH  
80.2060**



**80.2060**

**Meßbecher  
Measuring jugs  
Gobelets gradués  
Copas graduadas  
Misurini**

**80.2070** 0,25 l.

**80.2072** 0,5 l.

**80.2074** 1,0 l.

**80.2076** 1,5 l.

**80.2078** 2,0 l.



**80.2070 -80.2090**

**Petrischale  
Petri Dish  
Boîte de Petri  
Cubeta de Petri  
Scodella di Petri**

**80.2090** 100 X 20 mm



**80.2090**



## Zubehör · Accessories · Accessoires · Accesorios · Accessori

**Nierenschalen**  
**Kidney bowls**  
**Bassins réniformes**  
**Riñoneras**  
**Padelle reniformi**

80.2100	170 x 37 mm
80.2101	205 x 45 mm
80.2102	250 x 39 mm
80.2104	275 x 45 mm

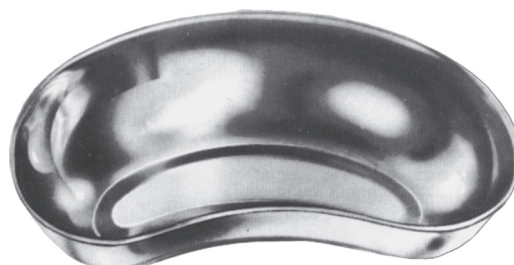

80.2100 -  
80.2104

**Runde Schalen**  
**Round Bowls**  
**Cuvettes rondes**  
**Cubetas redondas**  
**Scodelle rotonde**

80.2200	40 x 19 mm	0,05 l
80.2202	60 x 30 mm	0,07 l
80.2204	80 x 40 mm	0,14 l
80.2206	100 x 50 mm	0,20 l
80.2208	120 x 55 mm	0,35 l
80.2210	150 x 65 mm	0,70 l



80.2200 -  
80.2210

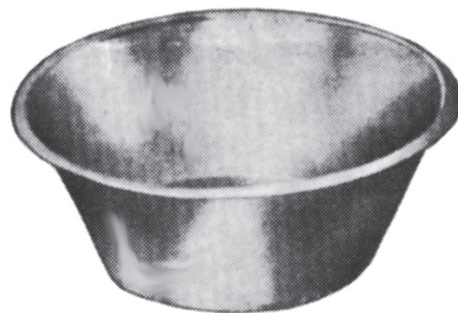

80.2240 -  
80.2262

80.2240	150 x 74 mm	0,75 l
80.2242	160 x 65 mm	1,00 l
80.2244	220 x 70 mm	2,00 l
80.2246	225 x 90 mm	2,50 l
80.2248	240 x 95 mm	3,00 l
80.2250	255 x 115 mm	4,00 l
80.2252	260 x 130 mm	4,50 l
80.2254	300 x 105 mm	6,00 l
80.2256	310 x 120 mm	6,00 l
80.2258	320 x 140 mm	8,00 l
80.2260	380 x 125 mm	11,00 l
80.2262	400 x 150 mm	14,00 l

**Kappenzangen mit Behälter und Deckel**  
**Sterilizing Forceps with jar and lid**  
**Pincas à stérilisation avec éprouvette et couvercle**  
**Pinzas para esterilización con recipiente y tapa**  
**Pinze per sterilizzazione con recipiente e coperchio**

80.2270	25 cm
80.2272	32 cm



80.2270 -  
80.2272

**Zubehör · Accessories · Accessoires · Accesorios · Accessori**

**Standgefäße**

Jars

Récipients cylindriques

Tarros

Recipienti cilindrici

<b>80.2280</b>	30 x 90 mm
<b>80.2282</b>	50 x 100 mm
<b>80.2284</b>	50 x 135 mm
<b>80.2286</b>	50 x 180 mm
<b>80.2288</b>	80 x 130 mm
<b>80.2290</b>	80 x 180 mm
<b>80.2292</b>	100 x 200 mm



**80.2280 -  
80.2292**

**Medizinbecher und -löffel**

Medicine Cups and Spoons

Gobelets et cuillère à médicaments

Vasos y cuchara para medicamentos

Bicchieri e cucchiaio per medicinali

<b>80.2300</b>	30 cc
<b>80.2302</b>	50 cc



**80.2300**



**80.2302**

<b>80.2310</b>	6,8 x 1,8 cm
----------------	--------------



**80.2310**

<b>80.2315</b>	11 x 2 cm
----------------	-----------



**80.2315**

## Zubehör · Accessories · Accessoires · Accesorios · Accessori

Instrumenttenablegeplatten  
Instrument depositing trays  
Plateaux pour déposer les instruments  
Bandejas para instrumentos  
Vassoi per strumenti

80.2400	210 x 160 x 10 mm
80.2401	240 x 180 x 10 mm
80.2402	310 x 150 x 10 mm
80.2406	310 x 210 x 10 mm
80.2407	400 x 270 x 20 mm
80.2408	420 x 280 x 10 mm

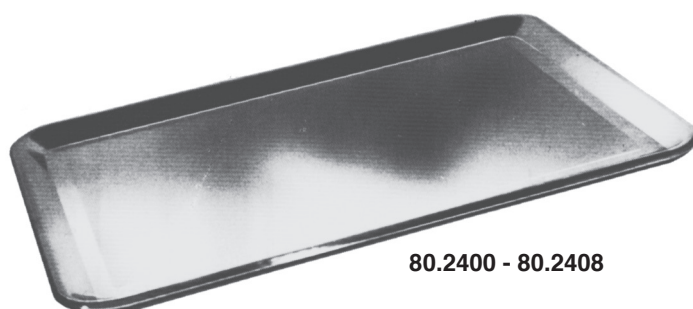

80.2400 - 80.2408

80.2430	230 x 155 x 30 mm
80.2432	300 x 175 x 30 mm
80.2434	300 x 175 x 40 mm
80.2436	350 x 240 x 36 mm
80.2438	400 x 300 x 50 mm



80.2400 - 80.2408

Instrumentenkästen  
Instrument Boxes  
Boîtes à Instruments  
Cajas para instrumentos  
Cestelli per strumenti

80.4100	16x10x 3 cm
80.4101	20x10x 5 cm
80.4102	22x15x 5 cm
80.4103	26x15x 5 cm
80.4104	30x20x 5 cm



80.4100 - 80.4104



# INHALTSVERZEICHNIS

## A

Abfallzangen	300
ABRAHAM Tonsillennmesser	147
Absaugrohre, Laryngo-Bronchoskopie	177
Absaugrohre, Rhinologie	96
Adenotome	126
ADSON anatomische Pinzetten	241
ADSON anatomische Pinzetten PROMEDUR	250
ADSON Arterienklemmen	262
ADSON chirurgische Pinzetten	242,243
ADSON-BABY Arterienklemmen	262
ADSON-BROWN chirurgische Pinzetten PROMEDUR	252
ADSON-DEBAKEY feine Gefäßspinzetten	241
ADSON-GRAEFE chirurgische Pinzette	243
ADSON-MIKRO chirurgische Pinzetten	242
ADSON-MIKRO Pinzetten mit LOCHGRIFF	241
ADSON-SELECT chirurgische Pinzette	242
Allgemeine HNO-Instrumente	211-298
ALLIS Organ- und Gewebefaßzangen	264,267
ALLIS Organ- und Gewebefaßzangen, atraumatisch	267
ALLIS-ADAIR Gewebefaßklemme 15,5 cm	267
ALLIS-BABY Organ- und Gewebefaßzangen	264
ALLPORT Ohrhäkchen	36
ALLPORT Wundspreizer	56
ALM Wundspreizer	55,56
ANATOMIE Scheren	226
anatomische Pinzetten	238-251
anatomische Pinzetten PROMEDUR	250
ANDREW Zungendrucker	129
ANDREW-PYNCHON Saugrohr	297
Antrum Messer	97
antraumatische Pinzetten	244,245,248-252
Antrumstanzen	84
ARRUGA Nadelhalter	287
Arterienklemmen	255-266
ASCH Septumzange	123
Aspiration, Sonden, Punktion	296-298
Attikusstanze, Rhinologie	87
AUFRIECHT Nasenflügelhaken	105
AUFRIECHT Nasenhaken	105
AUFRIECHT Nasenraspeln	118
AUFRIECHT Nasenschere	91
AUSTIN Diszisionsmesser für die Fußplatte	59
AUSTIN Flachmeißel, Mikro-Ohr	64
AUSTIN Knüpfpinzetten	253
AUSTIN Sichelmesser	59
AUTOFILL Ohrspritze selbstfüllend	23

## B

BABCOCK Organ- und Gewebefaßzangen	268
BABCOCK Organ- und Gewebefaßzangen PROMEDUR	268
BABCOCK-DEBAKEY Organ- und Gewebefaßzangen	268
BABY-ADSON Arterienklemmen	262
BABY-ALLIS Organ- und Gewebefaßzangen	264
BABY-CRILE Arterienklemmen	259
BABY-CRILE-WOOD Nadelhalter PROMEDUR	286
BABY-LEXER feine Präparierscheren	231
BABY-METZENBAUM Präparierscheren	228
BABY-MIXTER Arterienklemmen	266
BABY-SENN-MILLER Wundhaken	280
BACKHAUS Tuchklemmen	272
BALL & SOCKET Tuchklemmen für Papiertücher	273
BALLENGER Knorpelmesser	97
BALLENGER Schwingmesser	99
BALLENGER Septum Elevator	101
BALLENGER Tonsillenfasszange	140
BARANY Lärmtrömmel	22
BARBARA Mikro-Ohrhäkchen	61
BARBARA Mikro-Ohrnadeln	61,62
BARNHILL Ringmesser	125
BARRON Skalpgriff	216
BARRON Spülkanülen	94

BARSKY Hauthäkchen	105
Batteriegriffe für Laryngoskope	181,184
Batteriegriffe für Laryngoskope; KALTLICHT	188,190
BAUER Retraktoren, intra oral	157
BAUER Retraktoren, intra oral mit KALTLICHT	157
BAUMGARTNER Nadelhalter	291
BAUMGARTNER Nadelhalter PROMEDUR	285
BECKMAN Nasenspekula	73
BECKMANN (Negus) Ringmesser	124
BECKMANN Ringmesser	124
BEEBEE Drahtscheren	38
Behälter, Gefäße, Verschiedenes, Zubehör	317-321
Behälter, -Sterilisation	302
BELLUCCI Mikro-Ohrscheren	53
BERNHARD Tuchklemme	273
BEYER Attikusstanze	87
BEYER Hohlmeißelzangen	66,67
BILLEAU Ohrschlingen	35
BIRKETT Arterienklemmen	140
BISHOP Wangenhalter	131
BLANK antraumatische Pinzetten	244
BLOHMKE Tonsillenfasszange	140
Blutstillung, Stössel	45
BOEHLER Hohlmeißelzangen	67
BOEHLER Knochensplitterzangen	69
BOETTCHER Tonsillenschere	141
BOIES Nasenfraktur Elevatorium	107
BONNEY anatomische Pinzetten PROMEDUR	251
BONNEY chirurgische Pinzetten PROMEDUR	252
BOSE Trachealhaken	209
BOSE Wundspreizer	55,207
BOSWORTH Zungendrucker	130
BOUCHERON Ohrspekula	16
BOWMAN Speichelgang- und Kieferhöhlensonden	296
BOYNTON Nadelhalter	284
BOYS-ALLIS Organ- und Gewebefaßzangen	267
BROMPTON Schlauchroller	274
Broncho-Oesophagoskopiezangen	177,178
BROPHY anatomische Pinzetten	244
BROPHY chirurgische Pinzetten	247
BRUENINGS pneumatisches Ohrspekulum	19
BRUENINGS scharfe Nasenzangen	79
BRUENINGS Septatom	99
BRUENINGS Tonsillennmesser	147
BRUENINGS Tonsillenschnürer	148
BRUENINGS Verlängerungsrohre	175
BRUENINGS Zangenaufsätze	175
BRUENINGS Zungenspatel	129
BRUENINGS-BRUNK Kieferhöhlenhaken	94
Bruststütze für Operationslaryngoskope	195
Bruststützen für Narkose-Mundsperrerr	137
BRYANT Tupferzange	275
BÜCHS Wangenhaken	152
BUCHWALD Zungenspatel	129
BUCK Fremdkörperzängchen 11 cm	31
BUCK Ohrküretten	42
BUCKINGHAM Trepane	64
BUCKLEY Flachmeißel	45
BUCKLEY Hohlmeißel	45
Bulldog-Klemmen	256
BUNT Sterilisierklammer	301

## C

CANFIELD Tonsillennmesser	147
CAPLAN Nasenschere	92
CARPENTER Tonsillen-Dissektoren	144
CARREL Arterienklemme	257
CASTELNUOVO Kieferhöhlendoppelsonden	122
CASTROVIEJO Nadelhalter	284
CASTROVIEJO Nadelhalter PROMEDUR	284
Cerclagedraht SMO	166
CHAPUT Organ- und Gewebefaßzange	264
CHEATLE Sterilisierzange	300
CHEVALIER-JACKSON Broncho-Oesophagoskopiezangen chirurgische Pinzetten; Mikro	177 239,241,242



	Seite		Seite
chirurgische Scheren	227	DEBAKEY atraumatische Pinzetten PROMEDUR	251
CICHERELLI Hohlmeisselzangen	66	DEBAKEY atraumatische Pinzetten TITAN	248,249
CINELLI Nasen-Osteotome	111	DEBAKEY-ADSON feine Gefäßspinzetten	241
CINELLI Nasenschere	90	DEBAKEY-BABCOCK Organ- und Gewebefaßzangen	268
CITELLI Septumzangen	87	DEBAKEY-GERALD atraumatische Pinzetten	246
CLAR Stirnspiegel KALTLICHT	14	DEBAKEY-SELECT Nadelhalter DIAMANT	287
CLAR Stirnspiegel Ø 33 mm KALTLICHT mit	13	DENHARDT Mundsperrerr	128
CLAR-Stirnlampe	13	DERF Nadelhalter	291
CLAUS-EICKEN Tonsillennadel	145	DERF Nadelhalter PROMEDUR	285
CLEVELAND Knochensplitterzangen	68	Diagnostik	7-22
COAKLEY Antrumküretten	121	Diagnostikbestecke, HNO	8-12
COAKLEY Kieferhöhlen-Trokar	93	DIETER Hammerkopfzängchen	52
COLLER-CRILE Arterienklemmen	261	DIETRICH Bulldog Klemmen	256
COLLIER Nadelhalter	291	DINGMAN Jochbogen Elevatoren	161
COLLIN Gewebefaßfasszange	269	DINGMAN Jochbogen-Haken	160
COLLIN Skalpellgriffe	215,218	DINGMAN Mundsperrerr	134
COLLIN Zungenzange	138	Dissektoren, Mikro-Ohr	63
COLVER Tonsillenfasszangen	140	DOCKHORN Wangenhaken	152
Conchotome	81	DOUGLAS Kieferhöhlentrokar	93
CONVERSE Nasenretraktor	106	DOUGLAS Tonsillennmesser	147
CONVERSE Rhinoplastikmesser	98	DOYEN Nadelhalter	291
CONVERSE-ALAR Häkchen	106	DOYEN Zungenspatel	129
COPE Wundhaken	281	DOYEN-JANSEN Mundsperrerr	128
CORDES Zangenaufsätze	176	DRAFFIN Bipod für Mundsperrerr	137
COTTLE (Millard) Fingerringhäkchen	106	Drahtbiegezängchen HNO	52
COTTLE Alar Häkchen	106	Drahtscheren	37,38
COTTLE Applikationsinstrument	107	DRAHTSPANNER, automatisch	167
COTTLE Columnella Pinzette	78	Drahtspannzangen Kieferchirurgie	167
COTTLE Fixierpinzette	78	DUNHILL Arterienklemmen	259
COTTLE Hammer	49,113	DUPUY-WEISS Tonsillennadeln	145
COTTLE Knorpelfasspinzette	78	DUVAL Gewebefaßklemmen	269
COTTLE Knorpelquetschinstrument	107	DUVAL Gewebefaßklemmen PROMEDUR	269
COTTLE Meissel	110		
COTTLE Nasenflügelretraktor	105	<b>E</b>	
COTTLE Nasenhäkchen	104,105	EICKEN-KILLIAN Kieferhöhlen-Spülkatheter	94,95
COTTLE Nasenraspel	118	Elevatorien, HNO	39
COTTLE Nasenspekula	74	Elevatorien, Mikro-Ohr	65
COTTLE Osteotome	108	Elevatorien, Rhinologie	101,102
COTTLE Septum Elevatoren	101	Elevatorium für Endolaryngeale Mikrochirurgie	200
COTTLE Septummesser	98	Endoskopie-Container	310
COTTLE-BULLDOG Nasenscheren	90	Ersatzbirnen für Laryngoskope	181
COTTLE-DORSAL Nasenschere	90	Ersatzbirnen für Laryngoskope, Kaltlicht	188,190
COTTLE-KAZANJIAN Knochensplitterzange	68	EVES Tonsillenschneider	148
COTTLE-MASING Nasenscheren	91	EWALD anatomische Pinzetten	241
COUPLAND Saugrohr	95,297	EWALD chirurgische Pinzette	242
CRAIG Vomerzangen	80	EXTRA-ORAL Retraktoren	159,160
CRILE Arterienklemmen	259	EXTRA-ORAL Retraktoren mit Kaltlicht	159,160
CRILE Nadelhalter	292		
CRILE Wundhaken	280	<b>F</b>	
CRILE-BABY Arterienklemmen	259	Face-Lift Scheren	141
CRILE-COLLER Arterienklemmen	261	Face-Lift Wundhaken	106
CRILE-MURRAY Nadelhalter	292	Fadengabel für Endolaryngeale Mikrochirurgie	200
CRILE-RANKIN Arterienklemmen	261	FALK Tonsillennadeln	146
CRILE-WOOD Nadelhalter	292	FARABEUF Raspatorien	41
CRILE-WOOD Nadelhalter PROMEDUR	286	FARRELL Watteträger	25
CRILE-WOOD-BABY Nadelhalter PROMEDUR	286	FARRIOR Ohrspekula	17
CUSHING anatomische Pinzetten	246	FARRIOR Ohrtrichter SCHWARZ	17
CUSHING anatomische Pinzetten PROMEDUR	250	FAULKNER Antrumkürette	121
CUSHING Venenhaken	281	FAULKNER Antrummeissel	110
CUSHING-LANDOLT Nasenspekula	75	feine anatomische Pinzetten	244
		feine chirurgische Scheren	227
		feine Scheren	225-236
		feine Wundhaken	278-281
<b>D</b>		FERGUSON Saugkanülen	30
DANDY Arterienklemmen	260	FERGUSON Saugkanülen isoliert	30
DANDY-MOSQUITO Arterienklemme	260	Filter, Papier für Container	312
DANIELS Tonsillotome	149	Filter, Textil für Container	313
DAUGHTY (WÜRZBURG) Mundsperrerr	135	Filterhalter	312
DAVIS Sterilisierpinzetten	300	Filterspender	312
DAVIS-BOYLE Mundsperrerr	132	FINSEN Wundspreizer	55
DAVIS-MEYER Mundsperrerr	133	FISCH Dissektoren, Mikro-Ohr	63
DAY Ohrhäkchen	36	FISCH Perforatoren, Mikro-Ohr	64
DEAN Gewebescheren	92,141	FISCH Spülkanülen	28
DEAN Tonsillennmesser	147	FISCH Ohrsonden	25,296
DEAN Tonsillenscheren	141		
DEBAKEY atraumatische Pinzetten	248,249		

	Seite		Seite
FISHER Tonsillennmesser	147	GUNNAR-HEY Schlauchroller	274
Flach-Container	308		
Flachmeißel, Otologie	45-48	<b>H</b>	
FOCUS Halogen-Stirnlampe	14	HAJEK Hammer	49,113
FOERSTER Schwammzangen	275	HAJEK-BALLENGER Elevator	101
FOMON Nasenflügelhaken	105	HAJEK-CLAUS Kieferhöhlenstanze	87
FOMON Nasenflügelschere	90	HAJEK-KOFLER Keilbeinstanzen	86
FOMON Nasenplastikmesser	97	Häkchen für Endolaryngeale Mikrochirurgie	200
FOMON Nasenraspeln	116,117	Häkchen für Mikro-Ohr	61,62
FOMON Nasenraspeln PROMEDUR	117	HALLE Septum Elevatorium	100
FOMON Osteotome	109	HALSEY Nadelhalter	291
FOMON-DORSAL Nasenscheren	89	HALSEY Nadelhalter PROMEDUR	285
FOSTER-GILLIES Nadelhalter PROMEDUR	288	HALSEY-MIKRO Nadelhalter PROMEDUR	285
FOWLER Tonsillennmesser	147	HALSTED Arterienklemmen	262
FRAENKEL Kehlkopfpolypenpinzette	173	HALSTED-MOSQUITO Arterienklemmen	258
FRAENKEL Kehlkopfschere	174	Hämmer	49,113
FRAENKEL Zangenaufsätze	175	Hammerkopfszangen	52
FRAZIER Saugkanülen	29,30	Hangriff für Stabinstrumente	201
FRAZIER Saugkanülen isoliert	29,30	HARRISON Sterilisierzangen	300
FRAZIER Saugkanülen mit Kaltlichtanschluss	29	HARTMANN Arterienklemmen	257
FREER Elevatoren, Rhinologie	100	HARTMANN Ligaturklemme	257
FREER Flachmeißel	108	HARTMANN Nasenpolypenzange	77
FREER Mucosamesser	98	HARTMANN Nasenspekula	72
FREER Schleimhauthaken	104	HARTMANN Ohrkatheter	26
FREER Septum-Hohlmeißel	108	HARTMANN Ohrpolypenzangen	31
FREER Septummesser	99	HARTMANN Ohrspekula	16
FREER-INGALS Submukosamesser	98	HARTMANN Ohrzangen	32
Fremdkörperinstrumente, HNO	32,33,35,36	HARTMANN Scharfe Nasenzangen	84
FRIEDMANN Hohlmeißelzange	66	HARTMANN Scharfe Tonsillenzangen	84
FRIEDMANN-MINI Hohlmeißelzange	66	HARTMANN Spülkanülen	27
FULLER Einführungs-Instrument für Prothesen	52	HARTMANN Stimmgabeln	21
		HARTMANN Tamponzange	77
<b>G</b>		HARTMANN Zungendrucker	130
Gaumensegelhalter und -Retraktoren	142	HARTMANN-HALLE Nasenspekula	72
Gaumenspatelraspatorien	163	HARTMANN-MIKRO Arterienklemmen	257
Gefäße, Behälter, Zubehör, Verschiedenes	317-321	HARTMANN-MIKRO Ohrzangen	50
GEMINI Arterienklemmen	265	HARTMANN-WULLSTEIN Mikro-Ohrzangen	51
GEMINI-MINI Arterienklemmen	265	HARVEY Drahtschere	37
GERALD anatomische Pinzetten	246	HASLINGER Gaumensegelhalter	142
GERALD anatomische Pinzetten PROMEDUR	251	HEERMANN Handgriff	201
GERALD chirurgische Pinzetten	247	HEISTER Mundsperrer	128
GERALD chirurgische Pinzetten PROMEDUR	251	HENKE Tonsillen-Dissektoren	143
GERZOG Hammer	49,113	HERZFELD Ohrzangen	32
GEUDEL-NEGUS Laryngoskope	186	HEUWIESER Kieferhöhlenfasszange	80
Gewebefäßzangen	264,267-269	HEYMANN Nasenschere	89
GILLIES chirurgische Pinzette	243	HEYMANN scharfe Nasenzangen	79
GILLIES chirurgische Pinzette PROMEDUR	251	HNO Diagnostikbestecke	8-12
GILLIES Elevator	161	HNO Mikro-Instrumente	59-65
GILLIES Nadelhalter	293	HOFER Gaumenbogenhaken	142
GILLIES Nadelhalter PROMEDUR	289	HOFFMANN Ohrzangen	32
GILLIES-MINI Nadelhalter	293	Hohlmeißel, Otologie	45-48
GLASSMANN atraumatische Pinzetten	249	Hohlmeißelzangen	66-67
GOLDMAN-FOX Scheren	231	HOKE Osteotome	47
GOLDMANN Septumfraktur Elevatorium	107	HOLINGER Operationslaryngoskop	194
GOOD Tonsillenscheren	141	HOLTZHEIMER Wundspreizer	56
GORNEY (Killian) Nasenschere	92	HOUGH Meßsonde, Mikro-Ohr	65
GORNEY Face-Lift Scheren	141	HOUSE Meßsonden, Mikro-Ohr	65
GORNEY Saugdissektor	103	HOUSE Ohrküretten	42
GRAEFE Irispinzetten	238,239	HOUSE Schlauchverbindungsstück	28
GRAEFE Irispinzetten, TITANIUM	238	HOUSE Spülkanülen	28
GRAEFE-SELECT Irispinzetten	239	HOUSE Wundhaken	280
GRAZIL feine chirurgische Scheren	227	HOWARTH (Burton) Elevator	102
GREVEN Fasszangen	51	HUBER Unlversalgriff für Laryngo-Bronchoskopie	175
Griffe für Kehlkopfspiegel	172	HURD Tonsillendissektoren	143
Griffe für Mikro-Skalpellklingen	212	HURD Tonsillennadeln	146
Griffe für Skalpelle, Messer	212-219	HYLIN Raspatorien	41
GROSS Fremdkörperinstrumente	35	Hypopharinkoskop	192
GROSS Kornzangen	276		
GROSS Ohrlöffel & Haken	35	<b>I</b>	
GRUBER Ohrspekula	16	Indikatorschilder, Papier	311
GRUENWALD (Jansen) Nasenpinzetten	78	Infusionsflaschen-Öffnungszange	301
GUASTELLA-EY Osteotome	109	Injektion, Sonden, Aspiration, Punktion	296-298
GUILLEN Saugraspatorium	95	Injektionskanülen für Operationslaryngoskope	193
GUILFORD Drahtschere schwarz	38	Instrumenten Pflegeöl	317

	Seite		Seite
Instrumentenbügel	301	Kieferhöhlen-Spülkatheter	94-96
Instrumentenkästen	321	Kieferhöhlenstanze, Rhinologie	87
Instrumentenklammern	301	Kieferhöhlen-Trokare	93
Instrumentenschalen	321	Kieferhöhlen-Trokarnadeln	93
INTRA ORAL Retraktoren	157,158	KILLIAN Elevatorien	102
INTRA ORAL Retraktoren mit Kaltlicht	157,158	KILLIAN Nasenspekula	73
Intranasal Nadelhalter PROMEDUR	290	KILLIAN Spülkanüle	96
IRIS Scheren	224,225,231	KILLIAN-CLAUS Septum-Hohlmeißel	108
ITERSON Trachealhaken	209	KILNER feine Gewebescheren	91
<b>J</b>			
JACKSON Absaugrohre	177	KILNER Nadelhalter	291
JACKSON Kehlkopfpinzetten	173	KILNER Nadelhalter PROMEDUR	285
JACKSON Operationslaryngoskope	194	KILNER Nasenfluegelhäkchen	106
JACKSON Trachealhäkchen	209	KILNER-DAUGHTY Mundsperrerr	135
JACKSON Trachealkanülen	206	KIRSTEIN (Heymann) Nasenschere	89
JACOBSON-MIKRO Arterienklemmen	258	KLAPP Sehnenscheidenhaken	279
JAKO Dissektor	202	Klemmen, Allgemeine Chirurgie	255-269
JAKO Instrumente für Orale Endoskopie	201,202	Klingentferner für Skalpelle	219
JAKO Larynxhaken	202	KNIGHT Nasenpolypenzange	77
JAKO Larynxmesser	202	Knochensplittierzangen	68-69
JAKO Larynxsonde	202	Knüpfpinzetten	253
JAKO Sichelmesser	202	KOCHER Arterienklemmen	263
JAMESON Nasenscheren	88	KOCHER Kropfsonden	208
JAMESON-WERBER Schere	88	KOCHER-GRAZIL Arterienklemmen	263
JANSEN Ohrküretten	43	KOENIG Knochen-Hebel	39
JANSEN Wundspreizer	56	KOENIG Stimmgabel	22
JANSEN-MIDDLETON Scharfe Nasenzangen	81	KÖNIG Raspator	40
JEFFERSON chirurgische Pinzette	243	KÖNIG Wundhaken	279
JENNINGS Mundsperrerr	132	KONRICH Sterilisiertrommeln	316
JOBSON-HORNE Watteträger	25	Kopfschneider PROMEDUR	38
Jochbogen Elevatoren	161	Kornzangen, Schwammzangen	275 276
Jochbogen-Haken	160	Kranio-Maxillofaziale Chirurgie	151-170
JONES Tuchklemmen	272	KRAUSE Kieferhöhlentroker	94
JOSEPH (Masing)Nasennmesser mit Knopf	98	KRAUSE Nasen-Polypenschnürer	76
JOSEPH Doppelhäkchen	104	KRAUSE Ohr-Polypenschnürer	37
JOSEPH Messstab	120	KRAUSE Zangenaufsätze	176
JOSEPH Nasenhäkchen	104	KRAUSE-VOSS Nasen-Polypenschnürer	76
JOSEPH Nasennmesser	97,98	KROENIG Zungenspatel	129
JOSEPH Nasenraspeln	115	Kropfschere	208
JOSEPH Nasensägen	120	Kropfsonden	208
JOSEPH Periost-Elevator	102	KUHN-BOLGER Stirnhöhlenküretten	121
JOSEPH Raspator	101	Küretten, Mikro-Ohr	65
JOSEPH Sägeschutzführung	120	Küretten, Otologie	42-44
JOSEPH-MASING Elevatorium	102	Küretten, Rhinologie	121,122
JUDD-ALLIS Organ- und Gewebefaßzangen	267	<b>L</b>	
JULIAN Nadelhalter PROMEDUR	287	LA FORCE Adenotome	126
JURASZ Kehlkopfszangen	173	LABORDE Trachealdilatator	207
JUWELIER-Pinzetten	240	LACK Zungendrucker	130
<b>K</b>			
KABIERSKE Pulverbläser	24	LAHEY Organ- u. Gewebefasszangen	207
KALTLICHT-Laryngoskope	187-190	LAHEY-METZENBAUM Präparierscheren	228
Kaltlichtquelle Halogen	14	LANDAU Kieferhöhlen-Troker	93
Kaltlichtträger für Operationslaryngoskope	193	LANDOLD Griffe für Mikro-Skalpellklingen	212
KANTROWITZ Präparier- und Ligaturklemmen	265	LANE Tuchklemmen	273
Kappenzangen mit Standgefäß	319	LANGE Choanenhaken	105
KAYE Nadelhalter f. plastische Chirurgie PROMEDUR	289,290	LANGE Kehlkopfszange	174
KAYE-MILLARD Face-Lift Wundhaken	106	LANGE Zangenaufsatz	175
Kehlkopfpinzetten	173	LANGENBECK Nadelhalter PROMEDUR	287
Kehlkopfspiegel	172	LANGENBECK Ohrschlinge	35
Kehlkopfszangen	173,174	LANGENBECK-MINI Wundhaken	281
Kehlkopfszangen, Endolaryngeale Mikrochirurgie	199	Lärmtrommel	22
Keilbeinstanzen, Rhinologie	86	Laryngo-Broncho-Oesophagoskopie	171-197
KELLY Arterienklemmen	259	Laryngo-Bronchoskopie Zangen	178
KELLY Fistelscheren	226	Laryngo-Bronchoskopie Zangen	203
KELLY-RANKIN Arterienklemmen	261	Laryngologie	197-204
KELSEY-FRY Knochenahnen	166	Laryngo-Mikro-Scheren	198
Kennzeichnungsschilder	311	Laryngo-Mikro-Zängchen	198
KERRISON Keilbeinstanzen	86	Laryngoskope mit Kaltlicht	187-190
Kieferhöhlenfasszangen	80	Laryngoskope und Zubehör	179-190
Kieferhöhlenhaken	94	LAZAR Mikro-Knüpfpinzetten	253
Kieferhöhlenküretten	121	LE MEE Zungendrucker	130
Kieferhöhlensonden	296	LEMPERT Elevatorien	39
		LEMPERT Hohlmeißelzangen	67
		LEMPERT Raspatorien	40
		LEMPERT scharfe Löffel	44

	Seite		Seite
LERICHE Arterienklemmen	260	MEAD Hämmer	49,113
LERMOYEZ Kieferhöhlen-Trokare	93	Medizinbecher, graduiert	320
LeVASSEUR-MERRILL Retraktoren mit / ohne Kaltlicht	160	Medizinlöffel	320
LEWIS Nasenraspeln	118	Medizinschale	320
LEXER-BABY feine Präparierscheren	231	Meissel, Otologie	45-48
LEXER-MINI Hohlmeißel	48	Meißel, Rhinologie	108-111
LEXER-MINI Osteotome	48	MERSHON Kronendrucker	161
LEYLA Ohrspekulahalter	18	Messbecher, graduiert	318
LEYLA Ohrtrichterhalter	18	Messer für Endolaryngeale Mikrochirurgie	200
LICHTWITZ Kieferhöhlen-Trokar	93	Messer, Rhinologie	97-99
LICHTWITZ-BIER-Kieferhöhlen-Trokarnadeln	93	Messer, Skalpelle, Griffe	212-219
LINKSHÄNDER Klemmen	258	Meßsonden, Mikro-Ohr	65
LINKSHÄNDER Nadelhalter	286	Messstab, Rhinologie	121
LINKSHÄNDER Scheren	224,228,229	METZENBAUM Nadelhalter	292
Lippenretractoren	131	METZENBAUM Präparierscheren	228,229,232,233
LISTER-SINUS Tupferzangen	275	METZENBAUM-BABY Präparierscheren	228
LITTAUER Nasenpolypenzange	77	METZENBAUM-FINO Präparierscheren	230,234-236,235
LITTAUER Ohrpolypenzängchen	31	METZENBAUM-LAHEY Präparierscheren	228
LITTAUER-LISTON Knochensplitterzange	68	MICHEL Rhinoskopie Spiegel	172
LITTLEWOOD Organ- und Gewebefäßzangen	267	MIKRO anatomische Pinzetten	240
LOCKLIN Gewebescheren	89,92	Mikro-chirurgische Pinzetten	239,240-242
LOPEZ-REINKE Tonsillen-Dissektor	144	MIKRO-HALSEY Nadelhalter PROMEDUR	285
LORNA (Edna) Tuchklemmen für Papiertücher	273	MIKRO-HARTMANN Arterienklemmen	257
LOVE Nasenrachenraumretractoren	142	Mikro-Instrumente, Otologie	59-65
LOVELACE Arterienklemmen	260	MIKRO-JACOBSON Arterienklemmen	258
LUBET-BARBON Nasenpolypenzange	77	Mikro-Laryngo-Nadelhalter	199
LUC Scharfe Nasenzangen	80	Mikro-Laryngo-Scheren	198
LUCAE Hämmer	49,113	Mikro-Laryngo-Zängchen	198
LUCAE Ohrhäkchen	36	MIKRO-MOSQUITO Arterienklemmen	258
LUCAE Ohrmesser	34	Mikro-Ohr-Dissektoren	63
LUCAE Ohrpinzetten	33	Mikro-Ohrhäkchen	61,62
LUCAE Parazentesenadel	34	Mikro-Ohrnadeln	61,62
LUCAE Stimmgabel	22	Mikro-Ohrscheren	53-54
LUER Hohlmeißelzangen	66	Mikro-Ohrzängchen	50-52
LUER Sprechkanülen	206	Mikroscheren	222,223
LUER Trachealhäkchen	280	MILLER Doppelraspeln	119
LUER Trachealkanülen	206	MILLER Laryngoskop	183
LUKENS Thymus-Haken, doppelendig	210	MILLER Laryngoskope KALTLICHT	189
LUNIATSCHEK Tamponstopfer	144	MILLER-BABY Laryngoskop	182
		MILLER-BABY Laryngoskope KALTLICHT	189,190
<b>M</b>		MILLES I Mikroscheren gezahnt	223
MAGILL Absaugrohre	96	MILLIGAN Wundspreizer	57
MAGILL Katheterzangen	138	Mini-Container	308
MALTZ Nasenmesser	98	MINI-GEMINI Arterienklemmen	265
MALTZ Nasenraspeln	115	MINI-LANGENBECK Wundhaken	281
MALTZ Nasenraspeln PROMEDUR	115	Mischschalen	319
MALTZ Wundhaken	105	MIXTER feine Scheren	226
MARTIN Abfallzange	300	MIXTER-BABY Arterienklemmen	266
MARTINI Ohrküretten	42	MOBERG Nasen-Osteotome	111
MASING Septum Elevatorium	101	MOBERG Wundhaken	279
MASTIN Muskelklemme	207	Mobilisierhaken	168
MATHIEU Nadelhalter	293	MOLDENHAUER Ohrhebel	35
MATHIEU Nadelhalter PROMEDUR	288	MOLLISON Wundspreizer	57
MATHIEU Wundhaken	280	MOSQUITO Arterienklemme für LINKSHÄNDER	258
MATHIEU-KOCHER Nadelhalter PROMEDUR	288	MOSQUITO Arterienklemmen	258
MATHIEU-SLIM Nadelhalter	293	MOSQUITO-MIKRO Arterienklemmen	258
MAUNDER Mundkeil	128	Mund, Zunge, Tonsillektomie	127-150
MAYFIELD Hohlmeißelzange	67	Mundsperrerr	128,132-137
MAYO Instrumentenklammern	301	Mundwinkelhalter	131,152
MAYO Zungendrucker	129	Muskelklemme	207
MAYO-HABERISSER Drahtspannzangen	167	MYLES Scharfe Nasenzangen	81
MAYO-HEGAR Nadelhalter	292		
MAYO-HEGAR Nadelhalter PROMEDUR	286	<b>N</b>	
McDONALD Elevator	101	Nadeldosen	317,318
McGEE Drahtbiegezüngchen	52	Nadelhalter f. plastische Chirurgie	289,290
McGEE Mikro-Ohrhäkchen	61	Nadelhalter, Endolaryngeale Mikrochirurgie	199
McINDOE anatomische Pinzetten PROMEDUR	251	Nadelhalter, Naht	283-293
McINDOE Knochensplitterzangen	69	Nadeln, Mikro-Ohr	61,62
McINDOE Nasen-Osteotome	111	NAGER Gaumensegelhaken	142
McINDOE plastische Schere	141	NAGER Tonsillennadel	145
McINTOSH Laryngoskope	179-182	Naht, Nadelhalter	283-293
McINTOSH Laryngoskope KALTLICHT	187,188	Narkose-Mundsperrerr	132 - 137
McIVOR Mundsperrerr	134	Naselraspeln	115-119
McKENTY Elevatorien	100	Nasenfraktur Instrumente	107



	Seite		Seite
Nasenhäkchen	104-106	PARTSCH Hämmer	49,113
Nasenimplantatfixierpinzette	106	PARTSCH Hohlmeißel	46
Nasennmesser	97-99	PASSOW Blutstillungsmeißel	45
Nasenpinzetten	78	PEAN-FINO Arterienklemmen	263
Nasen-Polypenschnürer	76	PEARSON Hohlmeißelzange	66
Nasenpolypenzange	77	PECK-JOSEPH Nasenscheren	88
Nasentrachealraumretraktoren	142	PEERS Tuchklemme für Papiertücher	272
Nasensägen	120	PELKMANN Kornzangen	276
Nasensaugrohr	95	PENNINGTON Organ- und Gewebefaßzangen	264
Nasenscheren	88-92	PENNINGTON Septum Elevatorium	102
Nasensonden	102	Perforatoren, Mikro-Ohr	64
Nasenspekula	74-75	PERKINS Wundspreizer	58
Nasenzangen	79	PERWITZSCHKY Speichelgangschere	126
Nasenzangen	123	Petrischale	318
NEGUS Bruststütze für Mundsperrer	137	Pflegeöl für Instrumente	317
NEGUS Tonsillenzangen	139	PIERCE Kieferhöhlen-Trokare	93
NEIVERT Nadelhalter	292	PIERCE Septum Elevatorium	102
NEIVERT Nadelhalter PROMEDUR	286	PIFFARD Ohrküretten	35
NEIVERT Nasenflügelretractor	105	Pinzetten, Allgemeine Chirurgie	237-253
NEIVERT-ANDERSON Osteotome	109	Pinzetten, anatomisch	244
NEUROTONE-5 Stimmgabel	22	Pinzetten, anatomisch, FINO	244
NEW ORLEANS Nadelhalter PROMEDUR	287	Pinzetten, atraumatisch	244,245,248-252
NEWS Trachealhaken	210	Pinzetten, chirurgisch	245
Nierenschalen	319	Pinzetten, chirurgisch FINO	245
Noppenmatten, Silikon	313	Pinzetten, HNO	33
Noppenstreifen, Silikon	314	Pinzetten, Naht	253
NOYES Nasenpolypenzangen	77	Pinzetten, Rhinologie	78
<b>O</b>			
Oberkieferahle	166	PLESTER Führungsgabel	62
OBWEGESER Drahtösenzange	166	PLESTER Fußplattenhäkchen	62
OBWEGESER Jochbogenahle	166	PLESTER Lappenmesser	59
OBWEGESER Kinnhalter	156	PLESTER Mikro-Schaber	62
OBWEGESER Osteotome	165	PLESTER Spülkanülen	26
OBWEGESER Progenie Rinnen	156	PLESTER Wundspreizer	56,58
OBWEGESER Ramushaken	154	POLITZER (Buck) Furunkelmesser	34
OBWEGESER Raspatorien	162	POLITZER Ohrmesser	34
OBWEGESER Spalt-Osteotome	165	POLITZER Ohrspekula	16
OBWEGESER Spina Nasalis-Haken	154	POOLE Saugrohre	298
OBWEGESER Weichteilhaken	153	POST-MORTEM Skalpellklingen	217
OBWEGESER-FREER Elevatoren	161	POTTS-SMITH anatomische Pinzetten	246
OEHLER chirurgische Pinzetten PROMEDUR	252	POTTS-SMITH anatomische Pinzetten PROMEDUR	250
Ohrhäkchen	36	POTTS-SMITH chirurgische Pinzetten	248
Ohrkatheter	26	Präparier- und Ligaturklemmen	255-266
Ohrküretten	35,42-44	Präparierscheren	225-236
Ohrmesser	34	PRATT Antrumkürette	121
Ohrpinzetten	33	PRESBYTERIAN Schlauchklemmen	274
Ohr-Polypenschnürer	37	PRINCE Tonsillenschere	141
Ohrschlingen	35	Progenie Rinnen	156
Ohrsonden	25,296	PRO-MED Nadelhalter schwed. Model PROMEDUR	290
Ohrspekula	16-19	PRO-MED Nasenimplantatfixierpinzette	107
Ohrspritzen	23,24	PROVIDENCE-HOSPITAL Arterienklemmen	259
Ohrzängchen, Mikro	50-52	Pulverbläser	24
Öl zur Instrumentenpflege	317	Punktion, Sonden, Aspiration, Injektion	296-298
OLSEN-HEGAR Nadelhalter	293	<b>Q</b>	
OLSEN-HEGAR Nadelhalter für LINKSHÄNDER	293	QUIRE Fremdkörperzängchen	31
OLSEN-HEGAR Nadelhalter PROMEDUR	289	<b>R</b>	
OLSEN-HEGAR Nadelhalter PROMEDUR f. LINKSHÄNDER	289	RAGNELL (Kilner) feine Präparierschere	231
Operations-Laryngoskope und Zubehör	191-195	RAGNELL-DAVIS Wundhaken	280
Ophthalmoskope	8-12	Ramushaken	154,155
Orale Endoskopie	201,202	Ramus-Meißel	164
Organ- und Gewebefaßzangen	207,264,267-269	RANKIN-CRILE Arterienklemmen	261
ORINGER Lippenretraktoren	131	RANKIN-KELLY Arterienklemmen	261
Osteotome, Kieferschirurgie	164,165	Raspatoren, HNO	40,41
Osteotome, Otologie	47-48	Raspatorien, Rhinologie	103
Osteotome, Rhinologie	108-112	Rauchabsaugrohr für Operationslaryngoskope	193
OSTROEM Antrumstanzen	84	REICHERT Kehledeckelhalter	174
Otologie Instrumente	15-70	REINER-ALEXANDER Ohrspritzen	24
Otologie, Mikro-Instrumente	59 -65	Reinigungsdraht für FRAZIER/FERGUSON	30
Otoskope	8-12	Reinigungsdraht für MAGILL Absaugrohre	96
<b>P</b>			
PAREL Intranasal Nadelhalter PROMEDUR	290	Repositionszangen, Rhinologie	169
PARTSCH Flachmeißel	46	REYNOLDS Gewebescheren	88
		Rhinologie Instrumente	71-126
		Rhinoskope	8-12

	Seite		Seite
Rhinoskopiepiegel	172	Septum Elevatorien	101
RICHNAU-HOLMGREN Ohrspekula	17	Septum Morselizer	123
RING Zungendrücker	136	Septumnadeln	107
Ringmesser	124-125	Septumzangen, Rhinologie	87,123
RITTER-HALLE Stirnhöhlen-Dilatatoren	94,296	SEXTON Ohrmesser	34
ROCHESTER-PEAN Arterienklemmen	263	SHAMBAUGH-DERLACKI Elevator	39
ROEDER Tonsillenschnürer	148	SHAPLEIGH Ohrküretten	35
ROGER Elevator	100	SHEA Allzweckhaken	160
ROGGE Sterilisierzange	300	SHEA Ohrküretten, Mikro-Ohr	65
ROSE Trachealhaken	210	SHEA-BELLUCCI Mikro-Ohrscheren	54
ROSEN Elevatorien, Mikro-Ohr	65	SHEEHAN Nasen-Osteotome	112
ROSEN Inzisionsmesser	59	Sicherungsplomben, Plastik für Sterilisation	311
ROSEN Kürette, Mikro-Ohr	65	Siebbeinzangen	83, 84
ROSEN Mikro Messer	65	SIEBENMANN Kieferhöhlen-Spülkanülen	96
ROSEN Mikro-Ohrnadel	62	Siebkörbe	303,305,307309,310
ROSEN Mobilisationsinstrument	65	SIEGLE pneumatisches Ohrspekulum	19
ROSEN Rundschnittmesser	60	Silikon Noppenmatten	313
ROSEN Spülkanülen	27	SILIKON Noppenstreifen	314
ROSENBERG Zangenaufsatz	176	SILVER Osteotome	109
ROSER-KOENIG Mundsperrerr 19 cm	128	Skalpelle, Messer, Griffe	212-219
ROWE Repositionszangen	169	Skalpellgriffe	212,214-216,218-219
RUBIN Nasen-Osteotome	110	Skalpellgriffe mit cm-Einteilung	215,218
RUBIN Septum Morselizer	123	Skalpellslingen	212,213,217
RUMEL Präparier- und Ligaturklemmen	265	SLUDER-BALLENGER Tonsillotom	149
Runde Schalen	319	Sonde, Endolaryngeale Mikrochirurgie	200
RUSSEL-DAVIS Zungendrücker	136	Sonden, Aspiration, Punktion, Injektion	296-298
RYDEL-SEIFFER Stimmgabel	22	Sonden, Stirnhöhle	122
		Sortiermagazin für Kennzeichnungsschilder	311
		Speichelgang- und Kieferhöhlensonden	296
<b>S</b>		Speichelgangschere	126
Sägenschutzführung	120	Speichelgangsonde	94
SAUERBRUCH Abfallzange	300	SPRAGUE Ohrbesteck	34
SAUERBRUCH Nadeldose	318	Sprechkanülen	206
Saug- und Spülinstrumente, Otologie	26-30	Spritzen, Ohr	23,24
Saugraspatorium	95	Spülkanülen, Rhinologie	94-96
Saugrohre	297,297	Spülschalen	319
SAWTELL (George) Tonsillenzange	139	ST.CLAIR-THOMSON Ringmesser	125
SAWTELL Tonsillenzangen	139	STACKE Ohrsonde	25,296
SCHAEDEL Tuchklemme	272	STAMMBERGER Zirkulärstanzen	85
Scharfe Nasenzangen	79-87	STEINHÄUSER Ramus-Meissel	164
Scharfe Tonsillenzangen	84	STEINHÄUSER Ramus-Osteotome	164
SCHEINMANN Zangenaufsätze	175	STEINHÄUSER Zygomaticahaken	152
Schere, Speichelgang	126	STELLBRINK Hohlmeisselzangen	67
Scheren für LINKSHÄNDER	224,228,229	Sterilisation	299-316
Scheren, Allgemeine Chirurgie	221-236	Sterilisationszubehör	303-315
Scheren, Ohr, Mikro-	53-54	Sterilisierbehälter	302,304,306,308,310,316
Scheren, Rhinologie	88-92	Sterilisierpinzetten	300
Schilddrüsenhaken	210	Sterilisierrahmen für Mikro-Instrumente	315
SCHIMMELBUSCH Sterilisiertrommeln	316	Sterilisiertrommeln	316
Schlauchklemmen	274	Sterilisiertücher	313
Schlauchklemmen mit Schutzbügel	274	Sterilisierzangen	300
Schlauchroller	274	STERNBERG Wangenhaken	131
Schlingendraht für Nasen-Polypenschnürer	76	STEVENS Sehnenscheren	226
SCHMEDEN Conchotom	81	STILLE anatomische Pinzetten	244
SCHNIDT Tonsillenzangen	139	Stimmgabeln	20-22
Schnürerdraht für Polypenschnürer	37	Stirnhöhlen-Dilatatoren	94,296
Schnürerdraht für Tonsillenschnürer	148	Stirnlampe, Halogen	14
SCHOEMAKER Kropfschere	208	Stirnlampe, Halogen	14
SCHÖNBORN Schilddrüsenhaken	210	Stößel zur Blutstillung	45
SCHUKNECHT Biegezügchen	52	STRABISMUS Scheren	225,231
SCHUKNECHT Rollmesser	59	STRANDELL-STILLE Wundhaken	279
SCHUKNECHT Sichelmesser	59	STRINGER Instrumentenbügel	301
SCHUKNECHT Wundspreizer	58	STRUEMPPEL Ohrzügchen	32
SCHUMACHER Zangenaufsatz	176	Strumektomie Instrumente	207-208
Schwammzangen, Kornzangen	275 276	STRUYCKEN Scharfe Nasenzangen	81
SEBILEAU Elevator	39		
SEIFFERT Speichelgangsonde	94	<b>T</b>	
SEIFFERT Zangenaufsatz	175	TABB Sichelmesser	59
Seitenschneider PROMEDUR	38,166	TAKAHASHI Siebbeinzangen	83
SELDIN Periost Elevator	161	TAYLOR anatomische Pinzetten	247
SEMKEN anatomische Pinzetten PROMEDUR	250	TAYLOR chirurgische Pinzetten	248
SEMKEN chirurgische Pinzetten	243	TAYLOR-CUSHING anatomische Pinzetten	247
SENN-GREEN Wundhaken	281	TAYLOR-CUSHING chirurgische Pinzetten	248
SENN-MILLER Wundhaken	280	TESSIER Mobilisierhaken	168
SENN-MILLER-BABY Wundhaken	280		

	Seite		Seite
TESSIER Osteotome	165	WATSON-WILLIAMS Fasszange	79
TESSIER Raspatorien	162	WATSON-WILLIAMS Siebbeinzangen	79
THIESS Hämmer	49,113	Watteabfallbehälter	317
THUDICHUM Nasenspeka	75	Wattespender	317
Thymus-Haken	210	Watteträger	25
TIECK-HALLE Nasenspekula	73	WAUGH anatomische Pinzetten	247
TILLEY Tamponzange	31	WEBSTER Nadelhalter	291
TILLEY-HENCKEL Siebbeinzange	84	WEBSTER Nadelhalter PROMEDUR	285
TIVNEN-TYDING Tonsillenzangen	140	Weichteilehaken	153
TOBOLD Zungendrücken	129	WEIL-BLAKESLEY Scharfe Nasenzangen	82, 83
TOENNIS-ADSON feine Präparierscheren	232	WHITE Tonsillenfasszangen	139
TOHOKU Tuchklemmen	273	WHITEHEAD Mundsperrer	132
Tonsillendissektoren	143	WIBERG Raspatorien	103
Tonsillennmesser	147	WIEDER Zungendrücken	130
Tonsillennadeln	145-146	WIENER Antrumraspeln	118
Tonsillenscheren	141	WIENER Model Nasenspekula	72
Tonsillenschlingen	148	WILDE Nasen-Polypenschnürer	76
Tonsillenschnürer	148	WILDE Ohrpinzette	33
Tonsillenzangen	84, 139-140	WILDE Ohr-Polypenschnürer	37
Tonsillotome	149	WILLIGER Elevatorien	39
TOYNBEE Ohrspekula	16	WILLIGER Hammer	49,113
Trachealdilatatore	207	WILLIGER Ohrhäkchen	36
Trachealhäkchen	209,210,278	WILLIGER Ohrkürretten	43
Trachealkanülen	206	WILLIGER Raspatorien	40
Trachealtrokare	207	WILLIGER scharfe Löffel	44
Tracheotomie, Kropf	205-210	WISCONSIN-FOREGGER Laryngoskope	185
Tränenkanalsonden	296	WULLSTEIN Löffelzängchen	51
Transformator für Stirnspiegel	13	WULLSTEIN Mikro-Absaugkanülen	29
Trepane, Mikro-Ohr	64	WULLSTEIN Mikro-Löffelzängchen	50
TROELTSCH Nasenpinzetten	78	WULLSTEIN Mikro-Ohrscheren	53
TROELTSCH Ohrkatheter	26	WULLSTEIN Saugrohre	26
TROELTSCH Ohrpinzetten	33	WULLSTEIN Saugrohre konisch	26
TROUSSEAU Trachealdilatator	207	WULLSTEIN Sichelmesser	59
Tuchklemmen	272-273	WULLSTEIN Spül- u. Sauginstrument	26
TUFFIER Organ- und Gewebefäßzange	264	WULLSTEIN Wundspreizer	57
Tupferzangen	275	Wundhaken, Allgemeine Chirurgie	277-281
TYDING Tonsillennmesser	147	Wundspreizer	55 58
TYDING Tonsillenschnürer	148		
<b>U</b>			
UCKERMANN Trachealtrokar	207	YANKAUER Absaugrohre	297
UCKERMANN Watteträger	25	YANKAUER Septumnadeln	107
UNIV.MINNESOTA Zungendrücken	129	YASARGIL Mikroscheren	223
UNIVERSAL Drahtscheren	37	YOUNG Zungenzange	138
UNIVERSAL Kramponzange	38		
USA-Model anatomische Pinzetten	244	<b>Z</b>	
USA-Model chirurgische Pinzetten	245	Zangenaufsätze, Laryngo-Bronchoskopie	175
USA-Model Schlauchklemmen	274	Zangenbehälter	320
<b>V</b>			
VANNAS Mikroscheren	223	ZAUFAL Fremdkörperheber	36
Verlängerungsrohre für Laryngo-Bronchoskopie	175	ZAUFAL Ohrheber	35
Verschiedenes, Gefäße, Behälter, Zubehör	317-321	ZAUFAL-JANSEN Hohlmeisselzange	67
VIENNA Nasenspekulum leichtes Model	72	ZAUFAL-JANSEN Ohrhäkchen	36
WISE Mikro-Knüpppinzetten	253	ZIEGLER Drahtschneidezange PROMEDUR	167
VOLKMANN scharfe Löffel	44	ZIEGLER Stirnspiegel	13
VOLTOLINI Nasenspekula	75	Zirkulärstanzen, Rhinologie	85
Vomerzangen	80	ZOELLNER Ohrspekula	17
<b>W</b>			
WAGENER Ohrhäkchen	36	ZOELLNER Saugkanülen	27
WALKER feine Scheren	225	Zubehör, Behälter, Gefäße, Verschiedenes	317-321
WALSHAM Nasenzangen	123	Zubehör, Sterilisation	303-315
WALTER Nasenmeissel	110	Zungendrücken	129,130
WALTER Nasen-Osteotome	110	Zungenspateln	128,129,131
WALTER Nasenretraktor	106	Zungenzangen	138
WALTON Schwammzangen	275	Zygotatikhaken	152
Wangenhaken	131,152		
WANGENSTEEN anatomische Pinzette PROMEDUR	250		
Wasserspritze selbstfüllend	23		
WATSON-CHEYNE Elevator	101		
WATSON-CHEYNE Nasensonden	102		
WATSON-WILLIAMS Conchotome	81		

# ALPHABETICAL INDEX

## A

ABRAHAM Tonsil Knife	147
Adenoid Curettes	124-125
Adenotomes	126
ADSON Dressing Forceps	241
ADSON Dressing Forceps PROMEDUR	250
ADSON Hemostatic Forceps	262
ADSON Tissue Forceps	242
ADSON-BABY Hemostatic Forceps	262
ADSON-BROWN Tissue Forceps PROMEDUR	252
ADSON-DEBAKEY Tissue Forceps	241
ADSON-GRAEFE Tissue Forceps	243
ADSON-MICRO Dressing Forceps	241
ADSON-MICRO Tissue Forceps	242
ADSON-SELECT Dressing Forceps	241
ADSON-SELECT Tissue Forceps	242
ALLIS Atraumatic Tissue Forceps	267
ALLIS Tissue Holding Forceps	264
ALLIS-ADAIR Tissue Grasping Forceps	267
ALLIS-BABY Tissue Holding Forceps	264
ALLPORT Earhooklet	36
ALLPORT Self-Retaining Retractor	56
ALM Retractors	55,56
ANATOMY Scissors	226
ANDREW Tongue Depressor	129
ANDREW-PYNCHON Suction Tube	297
Antrum- and Sinus Trocars	93
Antrum Curettes	121
Antrum Knives	97
Antrum Polypus Grasping Forceps	80
Antrum Punches	84
Antrum Retractor	94
Antrum Trocar Needles	93
ASCH Septum Forceps	123
AUFRICHT Hook for posterior nares	105
AUFRICHT Nasal Rasps	118
AUFRICHT Nasal Scissors	91
AUFRICHT Retractor	105
AUSTIN Discission Knife for the footplat	59
AUSTIN Micro Chisels	64
AUSTIN Sickle Knife	59
AUSTIN Suture Tying Forceps	253
AUTOFILL Ear Syringe	23
Awls, Bone	166

## B

BABCOCK Tissue Holding Forceps	268
BABCOCK-DEBAKEY Tissue Holding Forceps	268
BABY-ADSON Hemostatic Forceps	262
BABY-BABY Tissue Holding Forceps	264
BABY-CRILE Hemostatic Forceps	259
BABY-CRILE-WOOD Needleholder PROMEDUR	286
BABY-LEXER Scissors PROMEDUR	231
BABY-MIXTER Hemostatic Forceps	266
BACKHAUS Towel Forceps	272
BALL and SOCKET Towel Forceps	273
BALLENGER Cartilage Knife	97
BALLENGER Septum Elevator	101
BALLENGER Swivel-Knives, RHINOLOGY	99
BALLENGER Tonsil Seizing Forceps	140
BARANY Noise apparatus	22
BARBARA Micro Needles, Picks	61,62
BARNHILL Adenoid Curettes	125
BARON Suction Tubes	94
BARRON Scalpel Handle	216
BARSKY Skinhook	105
Baskets, Sterilizing	303,305,307,309,311
Baskets, wire	303,305,307,309,311
BATTERY Handles for Laryngoscopes	181,184
BAUER Intra Oral Retractors	157
BAUER Intra Oral Retractors with fibre light	157
BAUMGARTNER Needleholder	291

Page

BAUMGARTNER Needleholder PROMEDUR	285
BECKMAN (Negus) Adenoid Curettes	124
BECKMAN Adenoid Curettes	124
BECKMAN Nasal Speculae	73
BEEBEE Wire Cutting Scissors	38
BELLUCCI Micro Scissors	53
BERNHARD Towel Forceps	273
BEYER Atticus Punch	87
BEYER Bone Rongeurs	66,67
BILLEAU Ear Loops	35
BIRKETT Tonsil Forceps	140
BISHOP Cheek Retractor	131
Blade Remover	219
BLANK atraumatic Dressing Forceps	244
BLOHMKE Tonsil Seizing Forceps	140
BOEHLER Bone cutting Forceps	69
BOEHLER Bone Rongeurs	67
BOETTCHER Tonsil Scissors	141
BOIES Nasal Fracture Elevator	107
Bone Chisels	45-48
Bone Curettes	44
Bone Elevators	39
Bone Rongeurs	66-67
BONE Wire SMO	166
Bonecutting Forceps	68-69
BONNEY Dressing Forceps PROMEDUR	251
BONNEY Tissue Forceps PROMEDUR	252
BOSE Tracheal Dilator	55,207
BOSE Tracheal Hooks	209
BOSWORTH Tongue Depressor	130
BOUCHERON Ear Specula	16
Bowls, Kidney	319
Bowls, round	319
Bowls, Solution	319
Bowls, Trays, Jars, Dispensers	317-321
BOWMAN Probes	296
Boxes, Instrument	321
Boxes, Sterilizing	316
BOYS-ALLIS Tissue Grasping Forceps	267
BROMPTON Tube Drainage Clamp	274
Broncho-Esophageal Forceps	177,178
BROPHY Dressing Forceps	244
BROPHY Tissue Forceps	247
BRUENINGS Ear Specula	19
BRUENINGS Extension Canulae	175
BRUENINGS Forceps Tips, Bronchoscopy	175
BRUENINGS Nasal Cutting Forceps	79
BRUENINGS Septatome	99
BRUENINGS Tongue Depressor	129
BRUENINGS Tonsil Knife	147
BRUENINGS Tonsil Snare	148
BRUENINGS-BRUNK Antrum Retractor	94
BRYANT Dressing Forceps	275
BÜCHS Cheek Retractor	152
BUCHWALD Tongue Depressor	129
BUCK Ear Curettes	42
BUCK Foreign Body Forceps	31
BUCKINGHAM Chisel	64
BUCKINGHAM Hand drills	64
BUCKLEY Bone Chisels	45
BUCKLEY Gouges	45
Bulldog Clamp non-traumatic	256
BUNT Sterilizing Clip	301

## C

CANFIELD Tonsil Knife	147
CAPLAN Nasal Bone Scissors	92
CARPENTER Tonsil Dissectors	144
CARREL Hemostatic Forceps	257
Cartilage Forceps	78
Cases, Needle	317,318
CASTELNUOVO Frontal Sinus Probes	122
CASTROVIEJO Needleholders	284
CASTROVIEJO Needleholders PROMEDUR	284
Catheter Introducing Forceps	138



	Page		Page
Catheters, Aspirating and Irrigating, RHINOLOGY	95,96	Curettes, Ear	35,43,43
CHAPUT Tissue Holding Forceps	264	Curettes, endaural	44
CHEATLE Sterilizing Forceps	300	Curettes, Maxillary Sinus-	120,121
Cheek Retractor swivelblade	131,152	Curettes, RHINOLOGY	121,122
Chest Supports and Support-rod for Op.Laryngoscopes	195	CUSHING Dressing Forceps	246
CHEVALIER-JACKSON Broncho-Esophageal Forceps	177	CUSHING Dressing Forceps PROMEDUR	250
Chisels, Cranio-Maxillo-Facial	164,165	CUSHING Retractors	281
Chisels, Bone	45-48	CUSHING-LANDOLT Nasal Speculae	75
Chisels, Micro	64		
Chisels, RHINOLOGY	108-112	<b>D</b>	
CICHERELLI Bone Rongeur	66	DANDY Hemostatic Forceps	260
CINELLI Nasal Osteotomes	111	DANDY-MOSQUITO Hemostatic Forceps	260
CINELLI Nasal Scissors	90	DANIELS Tonsillotomes	149
Circular Punches	85	DAUGHTY (WÜRZBURG) Tongue-Depressors	135
CITELLI Nasal Punches	87	DAVIS Sterilizing Forceps	300
Clamps, Tubing	274	DAVIS-BOYLE Mouth-Gag	132
CLAR Head Mirrors	13,14	DAVIS-MEYER Mouth-Gag	133
CLAUS-EICKEN Tonsil Needle	145	DAY Ear Hooklets	36
Cleaning Stylet for Suction Tubes	30	DEAN Nasal Scissors	92,141
Cleaning Wire for MAGILL Suction Tubes	96	DEAN Tonsil Knife	147
CLEFT-PALATE Raspatories	163	DEAN Tonsil Scissors	141
CLEVELAND Bone cutting Forceps	68	DEBAKEY Vascular Dressing Forceps	248,249
COAKLEY Antrum Curettes	121	DEBAKEY Vascular Dressing Forceps TITANIUM	248,249
COAKLEY Antrum Trocar	93	DEBAKEY Vascular Forceps PROMEDUR	251
Cold Light Projector	14	DEBAKEY-ADSON Tissue Forceps	241
COLLER-CRILE Hemostatic Forceps	261	DEBAKEY-BABCOCK Tissue Holding Forceps	268
COLLIN Scalpel Handles	215,218	DEBAKEY-GERALD Dressing Forceps	246
COLLIN Tissue Holding Forceps	269	DEBAKEY-SELECT Needleholders DIAMOND-JAW	287
COLLIN Tongue Holding Forceps	138	DENHARDT Mouth Gag	128
Columnella Forceps	78	Depressors, Tongue	128,129-131
COLVER Tonsil Seizing Forceps	140	DERF Needleholder	291
CONVERSE Nasal Retractor	106	DERF Needleholder PROMEDUR	285
CONVERSE Rhinoplasty Knife	98	DIAGNOSTICS	8-12
CONVERSE-ALAR Retractor	106	DIETER Malleous Nippers	52
COPE Retractor	281	DIETRICH Bulldog Clamps	256
CORDES Forceps Tips	176	Dilators, RHINOLOGY	94,296
COTTLE (Millard) Finger-Ring Hook	106	Dilators, TRACHEOTOMY	55,207
COTTLE Alar Retractor	106	DINGMAN Mouth Gag	134
COTTLE Bone- and Cartilage Guide	107	DINGMAN Periosteal Elevator	161
COTTLE Bone Crusher	107	DINGMAN Zygoma Elevator	161
COTTLE Cartilage Forceps	78	DINGMAN Zygoma Hooks	160
COTTLE Columnella Forceps	78	Directors, thyroid	208
COTTLE Elevators	101	Disimpaction Forceps	169
COTTLE Fixation Forceps	78	Disimpaction Forceps	169
COTTLE Mallet	49, 114	Dispenser for Filters	312
COTTLE Nasal Hooks, Retractors	104,105,106	Dispenser for Identification Labels	311
COTTLE Nasal Rasp	118	Dispensers, Cotton	317
COTTLE Nasal Speculae	74	Dissecting Scissors	141
COTTLE Osteotomes	108	Dissectors, Micro	63
COTTLE Septum Chisels	108,110	Dissectors, Tonsil	143,144
COTTLE Septum Knives	98	DOCKHORN Cheek Retractors	152
COTTLE-BULLDOG Nasal Scissors	90	DOUGLAS Tonsil Knife	147
COTTLE-DORSAL Nasal Scissors	90	DOYEN Needleholder	291
COTTLE-KAZANJIAN Bone cutting Forceps	68	DOYEN Tongue Depressors	129
COTTLE-MASING Nasal Scissors	91	DOYEN-JANSEN Mouth Gag	128
COTTLE-NEIVERT Hook for posterior nares	105	DRAFFIN Bipod for Mouth Gags	137
Cotton Applicators	25	Drapes, Sterilizing	313
Cotton Dispensers	317	Dressing Forceps FINO	244
Cotton Waste Collectors	317	Dressing Forceps General Surgery	244
COUPLAND Suction Tube	95	Dressing Forceps PROMEDUR	250
CRAIG Vomer Forceps	80	Dressing Forceps USA-MODEL	244
CRANIO-MAXILLO-FACIAL SURGERY	151-169	Drums, Sterilizing	316
CRILE Hemostatic Forceps	259	DUNHILL Hemostatic Forceps	259
CRILE Needleholders	292	DUPUY-WEISS Tonsil Needles	145
CRILE Retractor	280	DUVAL Tissue Holding Forceps	269
CRILE-BABY Hemostatic Forceps	259		
CRILE-COLLER Hemostatic Forceps	261	<b>E</b>	
CRILE-MURRAY Needleholder	292	Ear Cotton Applicators	25
CRILE-RANKIN Hemostatic Forceps	261	Ear Curettes	35,43,43
CRILE-WOOD Needleholders PROMEDUR	286	Ear Dressing Forceps	33
CRILE-WOOD-BABY Needleholders PROMEDUR	286	Ear Forceps	32,33
Cups, Medicine	320	Ear Foreign Body Instruments	31
Curettes, Adenoid	124-125	Ear Hooklets	36
Curettes, Antrum	121	Ear Knives	34
Curettes, Bone	44		

	Page		Page
Ear Loops	35	Forceps, Nasal Cutting	79-87
Ear Polypus Forceps	31	Forceps, Nasal Dressing- and Tissue	78
Ear Polypus Snares	37	Forceps, Nasal Tampon- and Polypus	77,78
Ear Specula	16-19	Forceps, Polypus	276
Ear Syringes	23, 24	Forceps, Septum	123
EICKEN-KILLIAN Irrigating Canulae	94,95	Forceps, Sponge and Dressing	275-276
Elevator, Bone	39	Forceps, Spreader graft Fixation	107
Elevators, Cranio-Maxillo-Facial	161,163	Forceps, Sterilizing	300
Elevators, Rhinology	100-102	Forceps, Suture tying	253
End Cutter for wires	38	Forceps, Tongue Holding	138
Endaural Curettes	44	Forceps, Tonsil	139-140
Endolaryngeal Microsurgery	200-203	Forceps, Vascular Dressing	248,249
ENT Diagnostic Sets	8-12	Forceps, Vomer	80
Epiglottis Retractor	174	Forceps, Waste	300
Ethmoid Forceps	79,83,84,85	Forceps, Wire bending	52
Eustachian Catheters	26	Foreign Body Instruments	31,35,36
EVES Tonsil Snares	148	Foreign Body Instruments, Ear	31
EWALD Dressing Forceps	241	FOSTER-GILLIES Needleholders PROMEDUR	288
EWALD Tissue Forceps	242	FOWLER Tonsil Knife	147
Extension Canulae, Bronchoscopy	175	FRAENKEL Forceps Tips	175
EXTRA ORAL Sigmoid Notch Retractors	159	FRAENKEL Laryngeal Polypus Forceps	173
		FRAZIER Suction Tubes	29,30
<b>F</b>		FRAZIER Suction Tubes insulated	29,30
Face-Lift Scissors	141	FRAZIER Suction Tubes, Fibre Optique	29
FALK Tonsil Needles	146	FREER Elevators	100
FARABEUF Bone Raspatories	41	FREER Mucous Hook	104
FARRELL Cotton Applicators	25	FREER Mucous Knife	98
FARRIOR Ear Specula oblique	17	FREER Septum Chisels	108
FARRIOR Ear Specula oval	17	FREER Septum Gouge	108
FARRIOR Ear Specula round	17	FREER Septum Knives	99
FARRIOR Ear Speculua BLACK	17	FREER-INGALS Submucosa Knife	98
FAULKNER Antrum Curette	121	FRIEDMANN-MINI Bone Rongeur	66
FAULKNER Antrum-Trocar Chisel	110	Frontal Sinus Probes	122
FERGUSON Suction Tubes	30	FULLER Prosthese-Introducing-Forceps	52
Fibre Optic Handles	187,188,189,190		
Filter Dispenser	312	<b>G</b>	
Filters, paper	312	Gauze Packer	144
Filters, textile	313	GEMINI Hemostatic Forceps	265
Fine Scissors	224-228,231-232	GEMINI-MINI Hemostatic Forceps	265
FINSEN Self-Retaining Retractors	55	GENERAL ENT INSTRUMENTS	211-321
FISCH Micro Dissectors	63	GERALD Dressing Forceps	246
FISCH Perforators	64	GERALD Dressing Forceps PROMEDUR	251
FISCH Suction Tips	28	GERALD Tissue Forceps	247
FISH Probes	25, 296	GERALD-DEBAKEY Dressing Forceps	246
FISHER Tonsil Knife	147	GEUDEL-NEGUS Laryngoscopes	186
FOCUS Halogen-Headlight	14	GILLIES Elevator	161
FOERSTER Sponge Forceps	275	GILLIES Needleholder	293
FOMON Nasal File	116	GILLIES Needleholder PROMEDUR	289
FOMON Nasal Hooks	105	GILLIES Tissue Forceps	243
FOMON Nasal Rasps	117,117	GILLIES Tissue Forceps PROMEDUR	251
FOMON Nasal Scissors	90	GILLIES-MINI Needleholder	293
FOMON Rhinoplastic Knife	97	GILLIES-MINI Needleholder PROMEDUR	289
FOMON Septum Chisels	109	GLASSMANN atraumatic Dressing Forceps	249
FOMON-DORSAL Nasal Scissors	89	Goitre Scissors	208
Forceps Holders	301	GOLDMAN-FOX Scissors PROMEDUR	231
Forceps Tips, Bronchoscopy	175,176	GOLDMANN Septum Displacer	107
Forceps, Antrum polypus grasping	80	GOOD Tonsil Scissors	141
Forceps, Broncho-Esophageal	177,178	GORNEY (Killian) Nasal Bone Scissors	92
Forceps, Cartilage	78	GORNEY Face-Lift Scissors	141
Forceps, Catheter Introducing	138	GORNEY Suction Dissector	103
Forceps, Columnella	78	Gouges	45-48
Forceps, Disimpaction	169	Gouges, Rhinology	108,110
Forceps, Disimpaction	169	GRAEFE delicate Dressing Forceps	238
Forceps, Dressing- and Tissue	237-253	GRAEFE delicate Dressing Forceps TITANIUM	238
Forceps, Ear	32,33	GRAEFE delicate Tissue Forceps	239
Forceps, Ear Dressing	32,33	GRAEFE-ADSON Tissue Forceps	243
Forceps, Ethmoid	79,83,84,85	GRAEFE-SELECT Dressing Forceps	238
Forceps, Hemostatic- and Dissecting	255-269	GRAEFE-SELECT Tissue Forceps	239
Forceps, Hemostatic for LEFT-HANDERS	258	GRAZIL Operating Scissors	227
Forceps, Laryngeal	173,174	GREVEN Ear Forceps	51
Forceps, Laryngo-Bronchoscopy	178	GROSS Foreign Body Instruments	35
Forceps, Micro Ear	51	GROSS Polypus Forceps	276
Forceps, Micro-Laryngeal	203	GRUBER Ear Specula	16
Forceps, Micro-Laryngo	198,199	GRUENWALD (Jansen) Tampon Forceps	78

	Page		Page
GRUENWALD Tissue Forceps	78	Hypopharyngoscope	192
GUASTELLA-EY Nasal Osteotomes	109		
GUILLEN Suction Raspatory	95	<b>I</b>	
GUILFORD Wire Cutting Scissors	38	Identification Labels	311
GUNNAR-HEY Tube Drainage Clamp	274	Indicating Labels	311
		INFUSION-Bottle Opening Forceps	301
<b>H</b>		Instrument Boxes	321
HAJEK Mallets	49, 113	Instrument Lubricant	317
HAJEK-BALLENGER Elevators	101	Instrument Trays	321
HAJEK-CLAUS Antrum Rongeur	87	Instruments for Thyroidectomy	206-207
HAJEK-KOFLER Rongeurs	86	Instruments, Micro Ear-	59-65
HALLE Septum Elevator	100	INTRA ORAL Retractors	158
HALOGEN Cold Light Projector	14	INTRA ORAL Retractors with fibre light	158
HALOGEN-Headlight	14	Intranasal Needleholders PROMEDUR	290
HALSEY Needleholders	291	IRIS Scissors	225,225,231
HALSEY Needleholders PROMEDUR	285	IRIS Scissors PROMEDUR	231
HALSEY-MICRO Needleholders PROMEDUR	285	Irrigating Canulae,Rhinology	95
HALSTED Hemostatic Forceps	262	Irrigating- & Suction Cannulae, Ear	26-29
HALSTED-MOSQUITO Hemostatic Forceps	258	Irrigating Syringe self-filling	23
Handle, Endolaryngeal Microsurgery	201	ITERSON Tracheal Hooks	209
Handles for Laryngeal Mirrors	172		
Handles, Scalpel	212,214-216,218-219	<b>J</b>	
HARRISON Sterilizing Forceps	300	JACKSON Laryngeal Forceps	173
HARTMANN Ear Polypus Forceps	31	JACKSON Operating Laryngoscopes	194
HARTMANN Ear Specula	16	JACKSON Tracheal Hooks	209
HARTMANN Eustachian Catheters	26	JACKSON Tracheal Tubes	206
HARTMANN Hemostatic Forceps	257	JACOBSON-MICRO Hemostatic Forceps	258
HARTMANN Ligature Forceps	257	JAKO Instruments, Endolaryngeal Microsurgery	201
HARTMANN Nasal Cutting Forceps	84	JAMESON Nasal Scissors	88
HARTMANN Nasal Polypus Forceps	77	JAMESON-WERBER Nasal Scissors	88
HARTMANN Nasal Speculae	72	JANSEN Self-Retaining Retractors	56
HARTMANN Suction Tubes	27	JANSEN-MIDDLETON Septum Compression Forceps	81
HARTMANN Tampon Forceps	77	Jars	320
HARTMANN Tongue Depressor	130	Jars, measuring	318
HARTMANN Tuning Forks	21	JEFFERSON Tissue Forceps	243
HARTMANN-HALLE Nasal Speculae	72	JENNINGS Mouth Gags	132
HARTMANN-MICRO Ear Forceps	50	JEWELLERS Micro Forceps	240
HARTMANN-MICRO Hemostatic Forceps	257	JEWELLERS-SELECT Micro Forceps	240
HARTMANN-WULLSTEIN Ear Forceps	51	JOBSON-HORNE Cotton-Applicators	25
HARVEY Wire Cutting Scissors	37	JONES Towel Clips	272
HASLINGER Soft Palate Retractor	142	JOSEPH (Masing) Nasal Knife	98
Head Mirrors	13,14	JOSEPH Measuring Rod	120
HEERMANN Handle for micro Instruments	201	JOSEPH Nasal Hooks	104
HEISTER Mouth Gag	128	JOSEPH Nasal Knife	98
Hemostatic- and Dissecting Forceps	255-269	JOSEPH Nasal Knives	97
Hemostatic- and Dissecting Forceps for LEFT-HANDERS	258	JOSEPH Nasal Rasps	115
HENKE Tonsil Dissectors	143	JOSEPH Nasal Saws	120
HERZFELD Ear Forceps	32	JOSEPH Periosteal Elevators	101,102
HEUWIESER Antrum Polypus Grasping Forceps	80	JOSEPH Saw Guide	120
HEYMANN Nasal Cutting Forceps	79	JOSEPH-MASING Elevator	102
HEYMANN Nasal Scissors	89	JUDD-ALLIS Tissue Grasping Forceps	267
HOFER Arch Palate Hook	142	JULIAN Needleholder PROMEDUR	287
HOFFMANN Ear Forceps	32	JURASZ Laryngeal Polypus Forceps	173
HOKE Osteotomes	47		
HOLINGER Operating Laryngoscope	194	<b>K</b>	
HOLTZHEIMER Self-Retaining Retractors	56	KABIERSKE Powder Blowers	24
Hooklets, Ear	36	KANTROWITZ Hemostatic Forceps	265
Hooklets, Endolaryngeal Microsurgery	200	KAYE Facelift-Needleholders PROMEDUR	289,290
Hooklets, Micro	61,62	KAYE-MILLARD Facelift Retractor	106
Hooks, Rhinology	104,105,106	KELLY Fistula Scissors	226
Hooks, Tendon	279	KELLY Hemostatic Forceps	259
Hooks, tracheal	209,210	KELLY-RANKIN Hemostatic Forceps	261
Hooks, Zygoma	160	KELSEY-FRY Bone Awls	166
HOUGH Measuring Rods	65	KERRISON Sphenoid Rongeurs	86
HOUSE Adapter Luer/Luer with thumb valve	28	KIDNEY-Shaped Trays	319
HOUSE Ear Curettes	42	KILLIAN Elevators	102
HOUSE Measuring Rods	65	KILLIAN Nasal Speculae	73
HOUSE Retractor	280	KILLIAN Wash Cannula	96
HOUSE Suction Tips	28	KILLIAN-CLAUS Septum Gouge	108
HOWARTH (Burton) Septum Elevator	102	KILNER Double Hooks for posterior nares	106
HUBER Universal handle	175	KILNER Needleholder	291
HURD Tonsil Dissectors	143	KILNER Needleholders PROMEDUR	285
HURD Tonsil Needles	146	KILNER Plastic Surgery Scissors	91
HYLIN Bone Raspatories	41		

	Page		Page
KILNER-DAUGHTY Mouth Gag	135	LITTAUER-LISTON Bone Cutting Forceps	68
KIRSTEIN (Heymann) Nasal Scissors	89	LITTLEWOOD Tissue Grasping Forceps	267
KLAPP Tendon Hooks	279	LOCKLIN Nasal Scissors	89
KLING-EX Blade Remover	219	LOCKLIN Nasal Scissors	92
KNIGHT Nasal Polypus Forceps	77	Loops, Ear	35
Knives, Ear	34	LOPEZ-REINKE Tonsil Dissector	144
Knives, Endolaryngeal Microsurgery	200	LORNA (Edna) Towel Forceps	273
Knives, Micro-Ear	59,60	LOVE Nasopharyngeal Retractors	142
Knives, Rhinology	97-99	LOVELACE Hemostatic Forceps	260
Knives, Tonsil	147	LUBET-BARBON Nasal Polypus Forceps	77
KOCHER Hemostatic Forceps	263	Lubricating Oil for Instruments	317
KOCHER Thyroid Directors	208	LUC Nasal Cutting Forceps	80
KOCHER-FINO Hemostatic Forceps	263	LUCAE Ear Dressing Forceps	33
KOENIG Bone Elevators	39	LUCAE Ear Hooklets	36
KOENIG Raspatory	40	LUCAE Ear Knife	34
KOENIG Retractors	279	LUCAE Mallets	49, 114
KOENIG Tuning Fork adjustable	22	LUCAE Tuning Fork adjustable	22
KONRICH Sterilizing Drums	316	LUCAE Tympanum Perforator	34
KRAUSE Antrum Trocar	94	LUCAS Chisels	46, 110
KRAUSE Ear Polypus Snare	37	LUCAS Gouges	46, 110
KRAUSE Forceps Tips	176	LUER Bone Rongeurs	66
KRAUSE Nasal Snare	76	LUER Retractor	280
KRAUSE-VOSS Nasal Snare	76	LUER Speaking Tubes	206
KROENIG Tongue Depressor	129	LUER Tracheal Tubes	206
KUHN-BOLGER Sinus-Curettes	121	LUKENS Thymus Retractor	210
		LUNIATSCHEK Gauze Packer	144
<b>L</b>		<b>M</b>	
LABORDE Trachea Dilator	207	MAGILL Catheter Introducing Forceps	138
LACK Tongue Depressors	130	MAGILL Suction Cannulae	96
Lacrimal Probes	296	Malleous Nippers	52
LA-FORCE Adenotomes	126	MALLET with Nylon Disks	49, 114
LAHEY Goitre Grasping Forceps	207	Mallets	49, 114
LAHEY-METZENBAUM Dissecting Scissors	228	MALTZ Nasal Knife	98
LANDAU Trocar	93	MALTZ Retractor	105
LANDOLD Scalpel Handles	212	MARTIN Waste Forceps	300
LANE Towel Forceps	273	MARTINI Ear Curettes	42
LANGE Choana Hook	105	MASING Septum Elevator	101
LANGE Forceps Tip	175	MASTIN Muscle Clamp	207
LANGE Laryngeal Polypus Forceps	174	MATHIEU Needleholders	293
LANGENBECK Ear Loops	35	MATHIEU Needleholders PROMEDUR	288
LANGENBECK Needleholder PROMEDUR	287	MATHIEU Retractors	280
LANGENBECK-MINI Retractors	281	MATHIEU-KOCHER Needleholders PROMEDUR	288
Laryngeal Forceps	173,174	MATHIEU-SLIM Needleholders	293
Laryngeal Mirror Handles	172	MAUNDER Oral screw	128
Laryngeal Mirrors	172	MAXILLARY Awl	166
Laryngo-Broncho-Oesophagoscopy	171-196	MAYFIELD Bone Rongeur	67
Laryngo-Bronchoscopy Forceps	178	MAYO Sterilizing Clips	301
Laryngology	197-203	MAYO Tongue Depressor	129
Laryngoscopes and Accessories	179-195	MAYO-HABERISSER Wire Twisters	167
Laryngoscopes, Operating	191-195	MAYO-HEGAR Needleholders	292
LAZAR Micro Tying Forceps	253	MAYO-HEGAR Needleholders PROMEDUR	286
LE MEE Tongue Depressor	130	McDONALD Dissector	101
LEFT-HANDER Hemostatic Forceps	258	McGEE Micro Hooklets	61
LEFT-HANDER Needleholders	286	McGEE Wire Bending Forceps	52
LEFT-HANDER Scissors	224,228,229	McINDOE Bone Cutting Forceps	69
LEMPERT Bone Raspatories	40	McINDOE Dressing Forceps PROMEDUR	251
LEMPERT Bone Rongeurs	67	McINDOE Nasal Chisels	111
LEMPERT Elevators	39	McINDOE Plastic Surgery Scissors	141
LEMPERT Endaural Curettes	44	McINTOSH Laryngoscopes	179-182
LERICHE Hemostatic Forceps	260	McINTOSH Laryngoscopes FIBER OPTIC	187,188
LERMOYEZ Sinus Trocars	93	McIVOR Mouth-Gag	134
LeVASSEUR-MERRILL Retractors	160	McKENTY Elevators	100
LEWIS Nasal Rasps	118	McKENTY Septum Elevator	100
LEXER-BABY Scissors PROMEDUR	231	Measuring Jars, graduated	318
LEXER-MINI Gouges	48	Measuring Rod, Rhinology	120
LEXER-MINI Osteotomes	48	Measuring Rods, Otology	65
LEYLA Ear Specula Holder complete	18	Medicine Cups graduated	320
LEYLA Ear Specula holder only	18	Medicine Spoon	320
LICHTWITZ Nasal Scissors	93,94	MERSHON Band Pusher	161
LICHTWITZ-BIER Antrum Trocar Needles	93	METZENBAUM Dissecting Scissors	228-230,232-236
Lip Retractors	131	METZENBAUM Dissecting Scissors SUPERCUT	228-230
LISTER-SINUS Sponge- and Dressing Forceps	275	METZENBAUM Needleholders	292
LITTAUER Ear Polypus Forceps	31	METZENBAUM-BABY Dissecting Scissors	228
LITTAUER Nasal Polypus Forceps	77		



	Page		Page
METZENBAUM-FINO Dissecting Scissors	230,234-236	NEIVERT Needleholder	292
MICHEL Laryngeal Mirrors	172	NEIVERT Needleholder PROMEDUR	286
Micro Chisels	64	NEIVERT-ANDERSON Nasal Osteotomes	109
Micro Dissectors	63	NEURO-TONE-5 Tuning Fork	22
MICRO Dressing Forceps	239,240	NEW ORLEANS Needleholder PROMEDUR	287
Micro Ear Curettes	65	NEWS Tracheal Hook	210
Micro Ear Forceps	50-52	Noise apparatus	22
Micro Ear Instruments	59-65	NOYES Nasal Polypus Forceps	77
Micro Ear Knives	59		
Micro Hooklets	61,62	<b>O</b>	
Micro Instruments Rack	314	OBWEGESER Channel Retractors	156
Micro Needles, Picks	61,62	OBWEGESER Chin Retractor	156
Micro Perforators	64	OBWEGESER Mandibular Awl	166
Micro Scissors	53-54,222-224	OBWEGESER Nasal Spine Retractor	154
Micro Tissue Forceps	239,240	OBWEGESER Osteotomes	165
MICRO-ADSON Dressing Forceps	241	OBWEGESER Periosteal Elevators	163
MICRO-ADSON Tissue Forceps	242	OBWEGESER Ramus Retractors	154
MICRO-HALSEY Needleholders PROMEDUR	285	OBWEGESER Raspatories	162
MICRO-HARTMANN Hemostatic Forceps	257	OBWEGESER Soft Tissue Retractors	153
MICRO-JACOBSON Hemostatic Forceps	258	OBWEGESER Splitter Chisels	165
Micro-Laryngeal Forceps	203	OBWEGESER Wire Loop Forceps	166
Micro-Laryngo-Alligator Forceps	198,199	OBWEGESER Zygomatic Awl	166
Micro-Laryngo-Needleholder	199	OBWEGESER-FREER Elevators	161
Micro-Laryngo-Scissors	198	OEHLER Tissue Forceps PROMEDUR	252
MICRO-MOSQUITO Hemostatic Forceps	258	OIL, lubricating	317
Micro-Scalpel Blades	212	OLSEN-HEGAR Needleholder for LEFT HAND	293
MILLER Laryngoscopes	183,184	OLSEN-HEGAR Needleholders	293
MILLER Laryngoscopes FIBER OPTIC	189,190	OLSEN-HEGAR Needleholders PROMEDUR	289
MILLER Nasal Rasps	119	Operating Scissors	227
MILLER-BABY Laryngoscope	182,184	Operating-Laryngoscopes & Accessories	191-195
MILLER-BABY Laryngoscope FIBER OPTIC	189,190	ORINGER Lip Retractors	131
MILLESI Micro Scissors	223	Osteotomes	47,48
MILLIGAN Self-Retaining Retractor	57	Osteotomes, Cranio-Maxillo-Facial	164,165
MINI-GEMINI Hemostatic Forceps	265	Osteotomes, Rhinology	108-112
MINI-GILLIES Needleholder	293	OSTROEM Antrum Punches	84
MINI-LANGENBECK Retractors	281	OTOLOGY	15-70
Mirrors, laryngeal	172	Oto-Ophthalmoscopes	8-12
Miscellaneous	317-321	Otoscopes	8-12
MIXTER Dissecting Scissors	226		
MIXTER-BABY Hemostatic Forceps	266	<b>P</b>	
MOBERG Nasal Osteotomes	111	Pads, Silicone	313
MOBERG Retractors	279	Palate Retractors	142
Mobilizers, maxillary	168	PAREL Intranasal Needleholders PROMEDUR	290
MOLDENHAUER Foreign Body Lever	35	PARTSCH Chisels	46
MOLLISON Self-Retaining Retractor	57	PARTSCH Gouges	46
MOSQUITO Hemostatic Forceps	258	PARTSCH Mallets	49, 113
MOSQUITO Hemostatic Forceps for LEFT HAND	258	PASSOW Hemostatic Tampers	45
MOSQUITO-MICRO Hemostatic Forceps	258	PEAN-FINO Hemostatic Forceps	263
Mouth Gags	128, 132-138	PEARSON Rongeur	66
Mouth, Throat, Tonsillectomy	127-149	PECK-JOSEPH Nasal Scissors	88
MYLES Nasal Cutting Forceps	81	PEERS Towel Forceps	272
		PELKMANN Sponge- and Dressing Forceps	276
<b>N</b>		PENNINGTON Septum Elevator	102
NAGER Soft Palate Retractor	142	PENNINGTON Tissue Holding Forceps	264
NAGER Tonsil Needle	145	Perforators, Micro-	64
Nasal Cutting Forceps	79-87	PERKINS Self-Retaining Retractors	58
Nasal Dressing- and Tissue Forceps	78	PERWITZSCHKY Salivary Gland Scissors	126
Nasal Hooks, Retractors	104,105,106	PETRI Dish	318
Nasal Rongeurs	86,87	PIERCE Antrum Trocars	93
Nasal Saws	120	PIERCE Septum Elevator	102
Nasal Scissors	88-92	PIFFARD Ear Curettes	35
Nasal Snares	76	PLESTER Flap Knife	59
Nasal Speculae	72-75	PLESTER Foot Plate Hook	62
Nasal Tampon- and Polypus Forceps	77,78	PLESTER Scraper	62
Needle Cases	317,318	PLESTER Self-Retaining Retractors	55,58
Needleholder, Micro-Laryngo	199	PLESTER Suction Tips	26
Needleholders	283-293	PLESTER Wire Guide	62
Needleholders for LEFT-HANDERS	285,286	POLITZER (Buck) Furuncle Knife	34
Needles, Antrum Trocar	93	POLITZER Ear Knives	34
Needles, Micro, Picks	61,62	POLITZER Ear Specula	16
Needles, Septum Suture	107	Polypus Forceps	276
NEGUS Chest Support for Mouth Gag	137	POOLE Suction Tubes	298
NEGUS Tonsil Forceps	139	POST-MORTEM Blades	217
NEIVERT Hook for Posterior Nares	105	POTTS-SMITH Dressing Forceps	246

	Page		Page
POTTS-SMITH Dressing Forceps PROMEDUR	250	ROSEN Needle	62
POTTS-SMITH Tissue Forceps	248	ROSEN Suction Cannulae	27
Powder Blowers	24	ROSENBERG Forceps Tip	176
PRATT Antrum Curette	121	ROSER-KOENIG Mouth Gags	128
PRESBYTERIAN Tubing Clamps	274	Round Edge Knife	200
PRINCE Tonsil Scissors	141	ROWE Disimpaction Forceps	169
Probe, Endolaryngeal Microsurgery	200	RUBIN Nasal Osteotomes	110
Probes, Aspiration, Puncture, Injection	295-298	RUBIN Septum Morselizer	123
Probes, Frontal Sinus	122	RUMEL Hemostatic Forceps	265
Probes, Lacrimal	296	RUSSEL-DAVIS Tonguedepressors	136
Probes, Rhinology	102	RYDEL-SEIFFER Tuning Fork	22
Probes, Salivary Tract- and Antrum	296		
PRO-MED Needleholder PROMEDUR	290	<b>S</b>	
PRO-MED Spreader Graft Fixation Forceps	107	Safety Seals	311
PROVIDENCE-HOSPITAL Hemostatic Forceps	259	Salivary Gland Scissors	126
Punches, Antrum	84	Salivary Probe	94
Punches, circular	85	Salivary Tract- and Antrum Probes	296
		SAUERBRUCH Needle Case	318
<b>Q</b>		SAUERBRUCH Waste Forceps	300
QUIRE Foreign Body Forceps	31	Saws, Rhinology	120
		SAWTELL (George) Tonsil Forceps	139
<b>R</b>		SAWTELL Tonsil Forceps	139
Rack for Micro Instruments	314	Scalpel Blade Remover	219
RAGNELL (Kilner) Sissors PROMEDUR	231	Scalpel Blades	212,213,217
RAGNELL Retractor	280	Scalpel Handles	212,214-216,218-219
RAMUS Retractors	155	Scalpel Handles calibrated	215,218
RANKIN-CRILE Hemostatic Forceps	261	Scalpel Handles for Micro Blades	212
RANKIN-KELLY Hemostatic Forceps	261	Scalpels and Handles	212-219
Raspatories, Bone	40-41	SCHAEDEL Towel Clips	272
Raspatories, Cranio-Maxillo-Facial	162	SCHEINMANN Forceps Tips	175
Raspatories, Rhinology	103	SCHIMMELBUSCH Sterilizing Drums	316
Rasps, Rhinology	115-119	SCHMEDEN Nasal Cutting Forceps	81
Rasps, Rhinology	115,116,117	SCHNIDT Tonsil Forceps	139
REICHERT Epiglottis Retractor	174	SCHOEMAKER Goitre Scissors	208
REINER-ALEXANDER Ear Syringes	24	SCHOENBORN Thyroid Retractor	210
Remover for Scalpel Blades	219	SCHUKNECHT Bending Forceps	52
Retractor, Antrum	94	SCHUKNECHT Self-Retaining Retractors	58
Retractor, Epiglottis	174	SCHUKNECHT Sickle Knife	59
Retractor, Sigmoid Notch	159	SCHUMACHER Forceps Tip	176
Retractors	277-281	Scissors, Dissecting	141
Retractors, Channel	156	Scissors, Face-Lift	141
Retractors, Cheek	152	Scissors, for LEFT-HANDERS	224,228,229
Retractors, Cheek, Lip	131	Scissors, General Surgery	221-236
Retractors, Chin	156	Scissors, General Surgery	222-236
Retractors, Extra-Oral	159,160	Scissors, Goitre	208
Retractors, Hand-held	278-281	Scissors, Micro General Surgery	222-224
Retractors, Intra-Oral	157,158	Scissors, Micro-Ear	53-54
Retractors, Nasal	104,105,106	Scissors, Nasal	88-92
Retractors, Nasal Spine	154	Scissors, Salivary Gland	126
Retractors, Palate	142	Scissors, Tonsil	141
Retractors, Ramus	154,155	Scissors, Wire Cutting	37,38
Retractors, Self-Retaining	55-58	SEBILEAU Bone Elevator	39
Retractors, Soft Tissue	153	SEIFFERT Forceps Tip	175
Retractors, Ttracheal	209,210	SEIFFERT Salivary Probe	94
Retractors, Zygomatic	152	SELDIN Elevator	161,162
REYNOLDS Nasal Scissors	88	Self-Retaining Retractors	55-58
RHINOLOGY	71-126	SEMKEN Dressing Forceps PROMEDUR	250
Rhinology Knives	97-99	SEMKEN Tissue Forceps	243
RICHNAU-HOLMGREN Ear Specula	17	SENN-GREEN Retractors	281
RING Tonguedepressors	136	SENN-MILLER Retractors	280
RITTER-HALLE Frontal Sinus Dilators	94,296	SENN-MILLER-BABY Retractors	280
ROCHESTER-PEAN Hemostatic Forceps	263	Septum Compression Forceps	81
ROEDER Tonsil Snare	148	Septum Forceps	123
ROGER Elevator	100	Septum Suture Needles	107
ROGGE Sterilizing Forceps	300	SEXTON Ear Knives	34
Rongeurs, Bone	66-67	SHAMBAUGH-DERLACKI Bone Elevator	39
Rongeurs, Nasal	86,87	SHAPLEIGH Ear Curettes	35
ROSE Tracheal Hook	210	SHEA Micro Ear Curettes	65
ROSEN Circular Knives	60	SHEA Multipurpose Retractor	160
ROSEN Ear Curette	65	SHEA-BELLUCCI Micro Scissors	54
ROSEN Incision Knife	59	SHEEHAN Nasal Osteotomes	112
ROSEN Micro Knife	65	Side-Cutter for wires	38,166
ROSEN Micro-Elevators	65	SIEBENMANN Irrigating Cannulae	96
ROSEN Mobilizer	65	SIEGLE pneumatic Ear Speculum	19

	Page		Page
Silicone Pads	313	Tissue Forceps USA Model	245
Silicone Storage Strip Set	314	TIVNEN-TYDING Tonsil Forceps	140
SILVER Nasal Osteotomes	109	TOBOLD Tongue Depressor	129
SLUDER-BALLENGER Tonsillotome	149	TOENNIS-ADSON Dissecting Scissors SUPERCUT	232
Snare Wires	37	TOHOKU Towel Forceps	273
Snare Wires for Nasal Snares	76	Tongue Depressors	128,129-131
Snare Wires, Tonsil-	148	Tongue Holding Forceps	138
Snares, Ear Polypus	37	Tonsil Dissectors	143,144
Snares, Nasal	76	Tonsil Forceps	139-140
Snares, Tonsil	148,149	Tonsil Knives	147
Solution Bowls	319	Tonsil Needles	145-146
Sponge- and Dressing Forceps	275-276	Tonsil Scissors	141
SPRAGUE Ear Operating Set	34	Tonsil Snares	148
Spreader Graft Fixation Forceps	107	Tonsillotomes	149
ST.CLAIR-THOMSON Adenoid Curettes	125	Towel- and Tubing Clamps	271-276
STACKE Ear Probe	25, 296	TOYNBEE Ear Specula	16
STAMMBERGER Circular Punches	85	Trachea Trocars	207
STEINHÄUSER Ramus-Chisels	164	Tracheal Dilator	55,207
STEINHÄUSER Ramus-Osteotomes	164	Tracheal Dilators	207
STEINHÄUSER Zygomatic Hooks	152	Tracheal Hooks	209,210
STELLBRINK Bone Rongeurs	67	Tracheal Tubes	206
Sterilization	299-316	Tracheotomy, Goitre	205 210
Sterilizing Baskets	303,305,307,309,311	Transformer for CLAR Head Mirrors	13
Sterilizing Boxes	316	Trays, Instrument	321
Sterilizing Containers	302,304,306,308,310,316	Trays, Kidney-shaped	319
Sterilizing Drapes	313	Trocars, Antrum- and Sinus	93,94
Sterilizing Drums	316	TROELTSCH Ear Dressing Forceps	33
Sterilizing Forceps	300	TROELTSCH Eustachian Catheters	26
Sterilizing Forceps with jar	319	TROELTSCH Tampon Forceps	78
Sterilizing Rack for Micro-Instruments	315	TROUSSEAU Trachea Dilator	207
STERNBERG Cheek Retractors	131	Tube Drainage Clamps	274
STEVENS Tenotomy Scissors	226	Tubes, Suction	298,298
STILLE Dressing Forceps	244	Tubes, Suction, Bronchoscopy	177
Storage Strip Set, Silicone	314	Tubes, tracheal	206
STRABISMUS Scissors	225,228	Tubing Clamps	274
STRABISMUS Scissors PROMEDUR	231	Tubing Clamps with safeguard	274
STRANDELL-STILLE Retractors	279	TUFFIER Tissue Holding Forceps	264
STRINGER Forceps Holders	301	Tuning Forks	20-22
STRUEMPEL Ear Forceps	32	TYDING Tonsil Knife	147
STRUYCKEN Nasal Cutting Forceps	81	TYDING Tonsil Snare	148
Suction Tips	26		
Suction Tubes	298,298	<b>U</b>	
Suction Tubes conical	27	UCKERMANN Cotton-Applicator	25
Suction Tubes, Bronchoscopy	177	UCKERMANN Trachea Trocars	207
Suction Tubes, Nasal	94-96	UNIV. MINNESOTA Tongue Depressor	129
Supports for Micro Instruments	314	UNIVERSAL Wire Cutting Pliers	38
Suture 283-293		UNIVERSAL Wire Scissors	37
Suture Guide, Endolaryngeal Microsurgery	200	USA-MODEL Tubing Clamps	274
Suture Needles, Septum	107		
Suture Tying Forceps	253	<b>V</b>	
Swedish Model Needleholder PROMEDUR	290	VANNAS Micro Scissors	223
		VIENNA Nasal Speculae	72
		VIENNA Nasal Speculum light model	72
		WISE Micro Tying Forceps	253
		VOLKMANN Bone Curettes	44
		VOLTOLINI Nasal Speculae	75
		Vomer Forceps	80
TABB Sickle Knife	59		
TABLET Dish	320	<b>W</b>	
TAKAHASHI Ethmoid Forceps	83	WALKER Iris Scissors	225
Tampers	45	WALSHAM Septum Forceps	123
TAYLOR Dressing Forceps	247	WALTER Nasal Chisels	110
TAYLOR Tissue Forceps	248	WALTER Nasal Osteotomes	110
TAYLOR-CUSHING Dressing Forceps	247	WALTER Nasal Retractor	106
TAYLOR-CUSHING Tissue Forceps	248	WALTON Sponge- and Dressing Forceps	275
TESSIER Maxillary Mobilizers	168	WANGENSTEEN Dressing Forceps PROMEDUR	250
TESSIER Osteotomes	165	Waste Collectors, Cotton	317
TESSIER Raspatories	162	Waste Forceps	300
THIESS Mallets	49, 113	WATSON-CHEYNE Elevator	101
THUDICHUM Nasal Speculae	75	WATSON-CHEYNE Probes	102
Thyroid Directors	208	WATSON-WILLIAMS Ethmoid Forceps	79
Thyroidectomy Instruments	206-207	WATSON-WILLIAMS Grasping Forceps	79
TIECK-HALLE Nasal Speculae	73	WATSON-WILLIAMS Nasal Cutting Forceps	81
TILLEY Tampon Forceps	31		
TILLEY-HENCKEL Ethmoid Forceps	84		
Tissue Forceps FINO	245		
Tissue Forceps General Surgery	245		

Page

WAUGH Dressing Forceps	247
WEBSTER Needleholder	291
WEBSTER Needleholders PROMEDUR	285
WEIL-BLAKESLEY Nasal Cutting Forceps	83,83
WHITE Tonsil Seizing Forceps	139
WHITEHEAD Mouth Gags	132
WIBERG Raspatories	103
WIEDER Tongue Depressors	130
WIENER Antrum Rasps	118
WILDE Ear Dressing Forceps	33
WILDE Ear Polypus Snare	37
WILDE Nasal Snare	76
WILLIGER Bone Curettes	44
WILLIGER Bone Elevators	39
WILLIGER Bone Raspatories	40
WILLIGER Ear Curettes	43
WILLIGER Ear Hooks	36
WILLIGER Mallet	49, 113
Wire Bending Forceps	52
Wire Cutter	167
Wire Cutting Instruments	37,38
Wire Loop Forceps	166
Wire Twisters	167
Wire, Bone SMO	166
Wires for Nasal Snares	76
WISCONSIN-FOREGGER Laryngoscopes	185
WULLSTEIN Cup Forceps	50
WULLSTEIN Irrigating- & Suction Cannula	26
WULLSTEIN Micro Ear Forceps	51
WULLSTEIN Micro Scissors	53
WULLSTEIN Micro Suction Canulae	29
WULLSTEIN Self-Retaining Retractors	57
WULLSTEIN Sickle Knife	59
WULLSTEIN Suction handle	29

**Y**

YANKAUER Septum Suture Needles	107
YANKAUER Suction Tubes	297
YASARGIL Micro Scissors	223
YOUNG Tongue Holding Forceps	138

**Z**

ZAUFAL Ear Lever	35
ZAUFAL Foreign Body Lever	36
ZAUFAL-JANSEN Bone Rongeur	67
ZAUFAL-JANSEN Earhooklet	36
ZIEGLER Head Mirror	13
ZIEGLER Wire-Cutter	167
ZOELLNER Ear Specula	17
ZOELLNER Micro Suction Canulae	27
Zygoma Hooks	160





# INDEX ALPHABETIQUE

## A

Abaisse-langue	128-136
Abaisse-langue avec aspiration	130
Abaisse-langue pour anesthésie	132-136
ABRAHAM Bistouri à agygdales	147
Accessoires	317-321
Accessoires pour stérilisation	303,305,307,309,311,314,315
Accroche-fil pour Microlaryngologie	200
Adénotomes	126
ADSON Pincés à dissequer	241
ADSON Pincés à dissequer PROMEDUR	250
ADSON Pincés à griffes	242,243
ADSON Pincés à griffes PROMEDUR	250
ADSON Pincés hémostatiques	262
ADSON-BABY Pincés hémostatiques	262
ADSON-BROWN Pince à dissequer PROMEDUR	252
ADSON-BROWN Pince à dissequer PROMEDUR	252
ADSON-DEBAKEY Pince à griffes	241
ADSON-DEBAKEY Pincés à dissequer	241
ADSON-GRAEFE Pince à griffes	243
ADSON-MICRO Pincés à dissequer	241
ADSON-MICRO Pincés à griffes	242
ADSON-SELECT MICRO Pince à sutures	242
ADSON-SELECT Pince à griffes	242
Aiguilles à ligatures	145,146
Aiguilles pour amygdales	145,146
Aiguilles à sutures	107
Aiguilles, boîtes à	317,318
Aiguilles, Crochets, ORL	62
Alène maxillaire	166
ALLIS Pincés à griffes pour tissus	264
ALLIS Pincés atraumatiques à préhension	267
ALLIS-ADAIR Pince à griffes pour tissus	267
ALLIS-BABY Pincés à griffes pour tissus	264
ALLPORT Crochet auriculaire	36
ALLPORT Ecarteur autostatique	56
ALM Ecarteurs autostatiques	55,56
Amygdalotomes	149
ANDREW Abaisse-langue	129
ANDREW-PYNCHON Tube d'aspiration	297
Anses à fil d'acier pour Serre-Noeuds	76
Anses à fil d'acier pour serre-noeuds amigdalien	148
Anses auriculaires	35
Anses pour Serre-noeuds auriculaires	37
ANTRUM Bistouris	97
ANTRUM Curettes	121
Appui pectoral avec tige pour Laryngoscopes	195
ASCH Pince pour la cloison nasale	123
Aspiration	297-298
Assourdisseur	22
AUFRIEHT Ciseaux nasaux	91
AUFRIEHT Crochet pour les ailes du nez	105
AUFRIEHT Râpes nasales	118
AUSTIN Burins	64
AUSTIN Couteau à discision	59
AUSTIN Couteau-serpette	59
AUSTIN Pincés à ligatures	253
AUTOFILL Seringue à irrigation	23
<b>B</b>	
BABCOCK Pincés à griffes pour tissus	268
BABCOCK-DEBAKEY Pincés pour tissus	268
BABY-ADSON Pincés hémostatiques	262
BABY-ALLIS Pincés à griffes pour tissus	264
BABY-CRILE Pincés hémostatiques	259
BABY-CRILE-WOOD Porte-Aiguilles PROMEDUR	286
BABY-LEXER Ciseaux à préparation PROMEDUR	231
BABY-METZENBAUM Ciseaux à préparation	228
BABY-MIXTER Pincés hémostatiques	266
BABY-SENN-MILLER Ecarteurs fins à main	280

BACKHAUS Pincés à champs	272
BACKHAUS Pincés à champs avec porte-tubes	272
BALL et SOCKET Pince à champs	273
BALLENGER Bistouri pour le cartilage	97
BALLENGER Couteaux mobs	99
BALLENGER Pince à amygdales	140
BALLENGER Septum Elevateur	101
Bande porte instruments, Silicone	314
BARANY Assourdisseur	22
BARBARA Crochets/Aiguilles	61
BARBARA Micro-Aiguille	62
BARNHILL Couteaux à végétations adénoïdes	125
BARRON Manche pour bistouris	216
BARRON Tubes aspiratrices	94
BARSKY Crochet à peau double	105
Bassins reniforme	319
BAUER Ecarteurs intra oreaux	157
BAUMGARTNER Porte-Aiguilles	291
BAUMGARTNER Porte-Aiguilles PROMEDUR	285
BECKMANN (Negus) Couteaux à végétations adénoïdes	124
BECKMANN Couteaux à végétations adénoïdes	124
BECKMANN Spéculum nasaux	73
BEEBEE Ciseaux à fils	38
BELLUCCI Micro-Ciseaux auriculaires	53
BERNHARD Pince à champs	273
BEYER Pince pour l'attique	87
BEYER Pincés-Gouge	66,67
BILLEAU Anses auriculaires	35
BIRKETT Pincés hémostatiques	140
BISHOP Ecarteur à joues	131
Bistouris à agygdales	147
Bistouris du nez	97,98
Bistouris pour Microlaryngologie	200
BLANK Pince à dissequer atraumatiques	244
BLOHMKE Pince à amygdales	140
BOEHLER Pincés coupantes à os	69
BOETTCHER Ciseaux pour amygdales	141
BOIES Elévateur pour fractures nasales	107
Boîtes à Aiguilles	317,318
Boîtes à instruments	321
Boîtes à Stérilisation INOX pour Micro-Instruments	316
Boîtes à stérilisation, ALU	302,304,306,308,310,316
Boîtes rondes à stérilisation	316
BONNEY Pince à dissequer PROMEDUR	251
BONNEY Pince à griffes PROMEDUR	252
BOSE Crochets trachéaux	209
BOSE Ecarteur pour Tracheotomie	55,207
BOSWORTH Abaisse-langue	130
Bouche, Langue, Amygdalectomie	127-149
Bougies pour Sinus frontal	94,296
BOWMAN Sondes à exploration	296
BOYS-ALLIS Pince à griffes pour tissus	267
BROMPTON Pince à drainage	274
BROPHY Pincés à dissequer	244
BROPHY Pincés à griffes	247
BRUENINGS Serre-noeud pour amygdales	148
BRUENINGS Abaisse-langue	129
BRUENINGS Bistouri à agygdales	147
BRUENINGS embout interchangeable	175
BRUENINGS Pincés coupantes para la nez	79
BRUENINGS Septatome ajustable	99
BRUENINGS Spéculum auriculaire pneumatique	19
BRUENINGS Tubes-rallonge	175
BRUENINGS-BRUNK Ecarteur pour sinus maxillaire	94
BRYANT Pince à tampons	275
BÜCHS Ecarteur à joues	152
BUCHWALD Abaisse-langue	129
BUCK Curettes auriculaires	42
BUCK Pince pour corps étrangers	31
BUCKINGHAM Burin	64
BUCKINGHAM Trépan	64
BUCKLEY Ciseaux-burin	45
BUCKLEY Gouges	45
BUNT Epingle à instruments	301

	Page		Page
<b>C</b>			
CANFIELD Bistouri à agygdales	147	COTTLE Instrument pour application	107
CANULE pour injections pour laryngoscopes	193	COTTLE Maillet	49, 114
Canules à aspiration	297,298	COTTLE Ostéotomes	108
Canules à aspiration conique	27	COTTLE pince à cartilage	78
Canules à aspiration, irrigation, ORL	26-29	COTTLE Pince à columnella	78
Canules aspiratrice, RHINOLOGIE	96-96	COTTLE Pince à fixation	78
Canules pour ponction	93	COTTLE presse pour matière cartilagineuse	107
Canules tracheales	206	COTTLE Râpe nasale	118
Canules tracheales parlantes	206	COTTLE Septum Elevateurs	101
CAPLAN Ciseaux nasaux	92	COTTLE Spéculums nasaux	74
CARPENTER Dissecteurs pour amygdales	144	COTTLE-BULLDOG Ciseaux nasaux	90
CARREL Pince hémostatique	257	COTTLE-DORSAL Ciseaux nasaux	90
CASTELNUOVO Sondes pour sinus maxillaire	122	COTTLE-KAZANJIAN Pince coupante à os	68
CASTROVIEJO Porte-Aiguilles	284	COTTLE-MASING Ciseaux nasaux	91
CASTROVIEJO Porte-Aiguilles PROMEDUR	284	Coupe à comprimés	320
Cathéter à lavage pour sinus maxillaire	94	COUPLAND Tubes d'aspiration	95,297
Champs à stérilisation	313	Couteaux à végétations adénoïdes	124-125
CHAPUT Pince à griffes pour tissus	264	Couteaux auriculaires	34
CHEATLE Pince à stérilisation	300	CRAIG Pinces pour vomer	80
Chevalet à Stérilisation pour Micro-Instruments	315	CRILE Ecarteur fin	280
CHEVALIER-JACKSON Pinces broncho-œsophagiennes	177	CRILE Pinces hémostatiques	259
Chirurgie de Crane et Macillo-Faciale	151-170	CRILE Porte-Aiguilles	292
Chrochet pour choana	105	CRILE-BABY Pinces hémostatiques	259
CICHERELLI Pince-Gouge	66	CRILE-COLLER Pinces hémostatiques	261
CINELLI Ciseaux nasaux	90	CRILE-MURRAY Porte-Aiguilles	292
CINELLI Ostéotomes	111	CRILE-RANKIN Pinces hémostatiques	261
Ciseaux à cartilages	141	CRILE-WOOD Porte-Aiguilles	292
Ciseaux à Chirurgie Générale	221-236	CRILE-WOOD Porte-Aiguilles PROMEDUR	286
Ciseaux à couper fils	37,38	CRILE-WOOD Porte-Aiguilles PROMEDUR pour GAUCHERS	286
Ciseaux à préparation	88	Crochets auriculaires	36
Ciseaux à préparation	228-236	Crochets fins	278
Ciseaux à préparation SUPERCUT	228-230	Crochets nasaux	104-106
Ciseaux à strabisme	225,231	Crochets pour les ailes du nez	105
Ciseaux à strabisme PROMEDUR	231	Crochets pour Microlaryngology	200
Ciseaux à strabisme SUPERCUT	225	Crochets pour zygoma	160
Ciseaux délicats pour Laryngoscopes	198	Crochets trachéaux	209
Ciseaux fins	91,224-226	Cuillère à médecine	320
Ciseaux nasaux	88-92	Curettes auriculaires	35
Ciseaux opératoires	227	Curettes pour antrum	121
Ciseaux pour amygdales	141	Curettes pour l'antré	121
Ciseaux pour cartilages	141	Curettes pour sinus	121
Ciseaux pour Face-Lift	141	Curettes, ORL	42-44
Ciseaux pour GAUCHERS	224,228,229	CUSHING Ecarteurs	281
Ciseaux pour goître	208	CUSHING Pinces à dissequer PROMEDUR	250
Ciseaux pour nerfs	226	CUSHING Pinces à griffes	246
Ciseaux pour voie salivaire	126	CUSHING-LANDOLT Spéculums nasaux	75
Ciseaux-burin, ORL	45,47,48	Cuvettes rondes	319
Ciseaux-burin, Rhinologie	108		
CITELLI Pinces-ostéotome	87	<b>D</b>	
CLAR Miroir frontal	13	DANDY Pinces hémostatiques	260
CLAR Miroir frontal à Lumière froide	14	DANDY-MOSQUITO Pince hémostatique	260
CLAUS-EICKEN Aiguilles à ligatures, amygdales	145	DANIELS Amygdalotomes	149
CLEVELAND Pinces coupantes à os	68	DAUGHTY (WÜRZBURG) Abaisse-langue	135
COAKLEY Curettes pour l'antré	121	DAVIS Pinces à stérilisation	300
COAKLEY Trocart pour sinus maxillaire	93	DAVIS-BOYLE Ouvre-bouche	132
COLLER-CRILE Pinces hémostatiques	261	DAVIS-MEYER Ouvre-bouche	133
COLLIER Porte-Aiguilles	291	DAY Crochets auriculaires	36
COLLIN Manches pour bistouris	215,218	DEAN Bistouris à agygdales	147
COLLIN Pinces pour tissus PROMEDUR	269	DEAN Ciseaux à cartilages	141
COLVER Pinces à amygdales	140	DEAN Ciseaux à préparation PROMEDUR	92,141
Containers à stérilisation	302,304,306,308,310,316	DEBAKEY Pinces atraumatiques	248,249
Containers plats à stérilisation	308	DEBAKEY Pinces atraumatiques PROMEDUR	251
CONVERSE Bistourie pour Rhinoplastie	98	DEBAKEY Pinces atraumatiques TITANIUM	248,249
CONVERSE Crochet pour les ailes du nez	106	DEBAKEY-ADSON Pinces à dissequer	241
CONVERSE-ALAR Crochet pour les ailes du nez	106	DEBAKEY-BABCOCK Pinces pour tissus	268
COPE Ecarteur fin	281	DEBAKEY-GERALD Pince à dissequer	246
CORDES embout interchangeable	176	DEBAKEY-SELECT Porte-Aiguilles DIAMANT	287
Corps étrangers, instruments	31-33,35	Decollateurs à amygdales	143
Coton, distributeurs et pouvelles	317	DENHARDT Ouvre-Bouche 12 cm	128
COTTLE (Millard) Crochet nasal	106	Depresseur de l'epiglotis	175
COTTLE Ciseaux-burin	108,110	DERF Porte-Aiguilles	291
COTTLE Couteaux pour le cloison nasale	98	DERF Porte-Aiguilles PROMEDUR	285
COTTLE Crochet pour les ailes du nez	105,106	Diagnostic	8-14
COTTLE Ecarteurs nasaux	105	Diapasons	20-22
		DIETER Pinces à plier les fils d'acier	52

	Page		Page
DIETRICH pinces hémostatiques BULLDOG	256	Filtres, textile	313
Dilatateur pour la Trachéotomie	207	FINSEN Ecarteurs autostatiques	55
DINGMAN Crochets pour zygomata	160	FISCH Canules à aspiration	28
DINGMAN Elevateur maxillofacial	161	FISCH Dissecteurs	63
DINGMAN Elevateur pour zygomata	161	FISCH Micro-Perforateurs	64
DINGMAN Ouvre-bouche	134	FISH Sondes à exploration	25, 296
Dissecteurs pour amygdales	144	FISHER Bistouri à agygdales	147
Distributeur à filtres	312	Fixe-filtres pour containers	312
Distributeurs de coton	317	FOCUS Halogen-Eclaireur frontal	14
DOCKHORN Ecarteurs à joues	152	FOERSTER Pincettes porte éponges	275
DOUGLAS Bistouri à agygdales	147	FOMON Ciseaux nasaux	90
DOUGLAS Trocart pour sinus maxillaire	93	FOMON Ciseaux-burin	109
DOYEN Abaisse-langue	129	FOMON Couteau pour rhinoplastie	97
DOYEN Porte-Aiguilles	291	FOMON Ecarteurs nasaux	105
DOYEN-JANSEN Ouvre-bouche	128	FOMON Lime double	116
DRAFFIN Bipode pour Ouvre-bouche	137	FOMON Râpes nasales	116
DUNHILL Pincettes hémostatiques	259	FOMON Râpes nasales PROMEDUR	117
DUPUY-WEISS Aiguilles à ligatures, amygdales	145	FOMON-DORSAL Ciseaux nasaux	89
DUVAL Pincettes pour tissus	269	FOSTER-GILLIES Porte-Aiguilles PROMEDUR	288
		FOWLER Bistouri à agygdales	147
<b>E</b>		FRAENKEL embouts interchangeable	175
Ecarteur "Facelift"	106	FRAENKEL Pince laryngienne oval	174
Ecarteur à joues mobile	131,152	FRAENKEL Pince pour polypes laryngienne	173
Ecarteur fixe-menton	156	FRAZIER Canules aspiratrices	29,30
Ecarteur nasopharyngal	142	FRAZIER Canules aspiratrices isolées	29
Ecarteur pour la voile du palais	142	FRAZIER Canules aspiratrices, lumière froide	29
Ecarteur pour sinus maxillaire	94	FREER Bistouri mucueuse	98
Ecarteur pour spina nasalis	154	FREER Ciseaux-burin	108
Ecarteur zygomatique	152	FREER Couteau mobil	99
Ecarteurs	277-281	FREER Crochet pour la muqueuse	104
Ecarteurs à joues	131,152	FREER Elevateurs, Rhinologie	100
Ecarteurs autostatiques, ORL	55-58	FREER Gouge nasal	108
Ecarteurs des lèvres	131	FREER Septum Elevateur	100
Ecarteurs extra oreaux	159,160	FREER-INGALS Couteau pour submuqueuse	98
Ecarteurs extra oreaux, fibre optique	159,160	FRIEDMANN Pince-Gouge	66
Ecarteurs fins à main	278-281	FRIEDMANN-MINI Pince-gouge	66
Ecarteurs intra oreaux	157,158	FULLER Pince à introduire prothèses	52
Ecarteurs intra oreaux, fibre optique	157,158		
Ecarteurs mandibulaires	157	<b>G</b>	
Ecarteurs nasaux	104-106	GAUCHERS, Ciseaux	224,228,229
Ecarteurs pour parties molles	153	GAUCHERS, Pincettes hémostatiques	258
Ecarteurs pour ramus	154,155	GAUCHERS, Porte-Aiguilles	286
Ecarteurs pour trachéotomie	209,210	GEMINI Pincettes hémostatiques	265
Ecarteurs, ORL	36	GEMINI-MINI Pincettes hémostatiques	265
Eclaireur frontal, Halogen	14	GERALD Pincettes à griffes	246,247
EICKEN-KILLIAN Canules à lavage pour sinus maxillaire	94,95	GERALD Pincettes à griffes PROMEDUR	251
Elevateur maxillofacial	161	GEUDEL-NEGUS Laryngoscopes	186
Elévateur pour Microlaryngology	200	GILLIES Elevateur maxillofacial	161
Elevateurs nasaux	101,102	GILLIES Pince à griffes	243
Elevateurs pour la cloison nasale	100-102	GILLIES Pince à griffes PROMEDUR	251
Elevateurs, ORL	39	GILLIES Porte-Aiguilles	293
Embouts interchangeable, Laryngo-, Broncho	175,176	GILLIES Porte-Aiguilles PROMEDUR	289
Epingles à instruments	301	GILLIES-MINI Porte-Aiguilles	293
Etiquettes d'identification en papier	311	GILLIES-MINI Porte-Aiguilles PROMEDUR	289
Etriers pour instruments	301	GLASSMANN pince atraumatique	249
EWALD Pince à dissequer	241	Gobelets à médecine	320
EWALD Pince à griffes	242	Gobelets gradués	318
Extracteur-Lames de bistouris	219	GOLDMAN-FOX Ciseaux PROMEDUR	231
		GOLDMANN Elévateur pour fractures	107
<b>F</b>		GOOD Ciseaux pour amigdales	141
Facelift Ecarteur	106	GORNEY (Killian) Ciseaux nasaux	92
FALK Aiguilles à ligatures / amygdales	146	GORNEY Ciseaux pour Face-Lift	141
FARABEUF Rugines	41	GORNEY Dissecteur à aspiration	103
FARRELL Portes-coton	25	Gouges, ORL	45-48
FARRIOR Speculums auriculaires	17	GRAEFE Pincettes à dissection	238
FARRIOR Speculums auriculaires NOIRE	17	GRAEFE Pincettes à griffes	239
FAULKNER Curette	121	GRAEFE-SELECT Pincettes à dissequer	238
FAULKNER Gouge antral	110	GRAEFE-SELECT Pincettes à dissequer TITANIUM	238
FERGUSON Canules aspiratrices	30	GRAEFE-SELECT Pincettes à griffes	239
FERGUSON Canules aspiratrices isolées	30	GRAZIL Ciseaux opératoires	227
FIBRE OPTIQUE Laryngoscopes	187-190	GREVEN Micro-Pincettes auriculaires	51
Fil d'acier pour Serre-Noeuds	37,76	GROSS Instruments pour corps étrangers	35
Fils d'acier SMO	166	GROSS Pincettes à pansement	276
Filtres, papier	312	GRUBER Speculums auriculaires	16



	Page		Page
GRUENWALD (Jansen) Pincés à pansements	78	ITERSON Ecarteur pour trachéotomie	209
GRUENWALD Pincés à dissection	78		
GRUENWALD Pincés à pansements	78	<b>J</b>	
GUASTELLA-EY Osteotomes	109	JACKSON Canules tracheales	206
GUILLEN Rugine-raspoir à succion	95	JACKSON Ecarteurs pour trachéotomie	209
GUILFORD Ciseaux à fils noir	38	JACKSON Laryngoscope opératoires	194
GUNNAR-HEY Pince à drainage	274	JACKSON Pince laryngienne	173
		JACKSON Tubes à aspiration	177
<b>H</b>		JACOBSON-MICRO Pincés hémostatiques	258
HAJEK Maillet	49, 113	JAKO Bistouris endolaryngienne	201,202
HAJEK-BALLENGER Septum Elevateurs	101	JAKO Crochet endolaryngien	201
HAJEK-CLAUS Pince pour sinus maxillaire	87	JAKO Dissecteur endolaryngien	202
HAJEK-KOFLER Pincés emporte-pieces	86	JAKO Sonde endolaryngienne	202
HALLE Septum Elevateur	100	JAMESON Ciseaux à préparation	88
Halogen-ECLAIREUR frontal	14	JAMESON Ciseaux à préparation	88
HALSEY Porte-Aiguilles	291	JAMESON Ciseaux à préparation SUPERCUT	88
HALSEY Porte-Aiguilles PROMEDUR	285	JAMESON-WERBER Ciseaux nasaux	88
HALSEY-MICRO Porte-Aiguilles PROMEDUR	285	JANSEN Curettes auriculaires	43
HALSTED Pincés hémostatiques	262	JANSEN Ecarteurs autostatiques	56
HALSTED-MOSQUITO Pincés hémostatiques	258	JANSEN-MIDDLETON Pincés pour cloison nasale	81
HARRISON Pincés à stérilisation	300	JEFFERSON Pince à griffes	243
HARTMANN Abaisse-langue	130	JENNINGS Ouvre-bouche	132
HARTMANN Canules à aspiration	27	JOBSON-HORNE Portes-coton	25
HARTMANN Diapasons	21	JONES Pincés à champs	272
HARTMANN Pince à ligatures	257	JOSEPH Bistouris du nez	97,98
HARTMANN Pincés à pansement	77	JOSEPH Crochets nasaux	104
HARTMANN Pincés auriculaires	32	JOSEPH Elevateurs pour Rhinoplastie	101,102
HARTMANN Pincés coupantes pour le nez	84	JOSEPH Mesureur	120
HARTMANN Pincés hémostatiques	257	JOSEPH protecteur pour scies	120
HARTMANN Pincés pour amygdales	84	JOSEPH Râpes nasales	115
HARTMANN Pincés pour corps étrangers	31	JOSEPH(Masing) Bistouri du nez	98
HARTMANN Sondes auriculaires	26	JOSEPH-MASING Elevateur	102
HARTMANN Speculums auriculaires	16	JOSPEH Scies nasales	120
HARTMANN Spéculums nasaux	72	JUDD-ALLIS Pincés à griffes pour tissus	267
HARTMANN-HALLE Spéculums nasaux	72	JULIAN Porte-Aiguilles PROMEDUR	287
HARTMANN-MICRO Pincés auriculaires	50	JURASZ Pince laryngienne	173
HARTMANN-MICRO Pincés hémostatiques	257		
HARTMANN-WULLSTEIN Micro-Pincés auriculaires	51	<b>K</b>	
HARVEY Ciseaux à fils	37	KABIERSKE lances-poudre	24
HASLINGER Ecarteur pour la voile du palais	142	KANTROWITZ Pincés hémostatiques	265
HEERMANN Manche pour instruments de Microchirurgie	201	KAYE Porte-Aiguilles PROMEDUR	289,290
HEISTER Ouvre-Bouche	128	KAYE-MILLARD Facelift Ecarteur	106
HENKE Decollateurs à amygdales	143	KcKENTY Septum Elevateur	100
HERZFELD Pincés auriculaires	32	KELLY Ciseaux	226
HEUWIESER Pincés à préhension pour sinus	80	KELLY Ciseaux SUPERCUT	226
HEYMANN Ciseaux nasaux	89	KELLY Pincés hémostatiques	259
HEYMANN Pincés coupantes para la nez	79	KELLY-RANKIN Pincés hémostatiques	261
HOFER Crochet pour voute palatine	142	KELSEY-FRY Alènes	166
HOFFMANN Pincés auriculaires	32	KERRISON Pincés emporte-pieces	86
HOKE Ostéotomes	47	KILLIAN Elevateurs pour la cloison nasale	102
HOLINGER Laryngoscope opératoire	194	KILLIAN Spéculums nasaux	73
HOLTZHEIMER Ecarteurs autostatiques	56	KILLIAN Tube pour lavage	96
HOUGH Sonde de mesure	65	KILLIAN-CLAUS Gouge nasal	108
HOUSE Adaptateur Luer/Luer avec interrupteur	28	KILNER Ciseaux fins	91
HOUSE Canules à aspiration	28	KILNER Crochet double pour les ailes du nez	106
HOUSE Curettes auriculaires	42	KILNER Porte-Aiguilles	291
HOUSE Ecarteur fin	280	KILNER Porte-Aiguilles PROMEDUR	285
HOUSE Sondes de mesure	65	KILNER-DAUGHTY Ouvre-bouche	135
HOWARTH (Burton) Elevateur	102	KIRSTEIN (Heymann) Ciseaux nasaux	89
HUBER Manche Universel	175	KLAPP Ecarteurs à tendineuses	279
Huile pour instruments	317	KLING-EX Extracteur-Lames	219
HURD Aiguilles à ligatures / amygdales	146	KNIGHT Pince à polypes nasaux	77
HURD Decollateurs à amygdales	143	KOCHER Pincés hémostatiques	263
HYLIN Rugines	41	KOCHER Sondes à goitre	208
Hyperpharyngoscope	192	KOENIG Diapason réglable	22
		KOENIG Elevateurs	39
		KOENIG Rugine	40
<b>I</b>		KÖNIG Ecarteurs fins à main	279
Instruments Generaux pour ORL	211-298	KONRICH Boîtes rondes à stérilisation	316
Instruments pour Thyroïdectomie	207-208	KRAUSE embout interchangeable	176
Intranalsal Porte-Aiguilles PROMEDUR	290	KRAUSE Serre-noeud pour polypes	37
IRIS Ciseaux	224,225,231	KRAUSE Serre-noeuds nasaux	76
IRIS Ciseaux pour GAUCHERS	224	KRAUSE Trocart pour sinus maxillaire	94
IRIS Ciseaux PROMEDUR	231	KRAUSE-VOSS Serre-noeud nasal	76
IRIS Ciseaux SUPERCUT	224		

	Page		Page
KROENIG Abaisse-langue	129	<b>M</b>	
KUHN-BOLGER Curettes pour sinus	121	Magasin à étiquettes d'identification	311
<b>L</b>		MAGILL Pincés à intubation	138
LABORDE Dilatateurs tracheaux	207	MAGILL Tubes à aspiration	96
LACK Abaisse-langue	130	MAILLET, disques Nylon	49, 114
LA-FORCE Adénotomes	126	MALTZ Bistouri nasal avec protecteur	98
LAHEY Pincés pour saisir le tissu	207	MALTZ Ecarteur nasal	105
Lames de bistouris	213,217	MALTZ Râpes nasales	115
Lames de Bistouris et Manches	212-219	MALTZ-TC Râpes nasales	115
Lances-poudre	24	Manches pour bistouris	212,214-216,218-219
LANDAU Trocart pour sinus maxillaire	93	Manches pour bistouris calibrés	215,218
LANDOLD Manches pour microbistouris	212	Manches pour microbistouris	212
LANE Pince à champs	273	Manches pour miroirs laryngiens	172
LANGÉ Crochet pour choana	105	MARTIN Pince à déchets	300
LANGÉ embout interchangeable	175	MARTINI Curettes auriculaires	42
LANGÉ Pince laryngienne	174	MARTINI Curettes auriculaires	42
LANGENBECK Anse auriculaire	35	MASING Septum Elevateur	101
LANGENBECK Porte-Aiguilles PROMEDUR	287	MASTIN Pince musculaire	207
LANGENBECK-MINI Ecarteurs fins	281	MATHIEU Ecarteurs fins à main	280
Laryngo-Broncho-Oesophagoscopie	171-195	MATHIEU Porte-Aiguilles	293
Laryngologie	197-203	MATHIEU Porte-Aiguilles PROMEDUR	288
Laryngoscope	179-190	MATHIEU-KOCHER Porte-Aiguilles PROMEDUR	288
Laryngoscopes opératoires	191,192	MATHIEU-SLIM Porte-Aiguilles	293
LAZAR Micro-Pince à ligatures	253	MAUNDER Ouvre-bouche en bois	128
LE MEE Abaisse-langue avec aspiration	130	MAYFIELD Pince-Gouge	67
LEMPERT Curettes tranchantes	44	MAYO Abaisse-langue	129
LEMPERT Elevateurs	39	MAYO Epingles à instruments	301
LEMPERT Pincés-Gouge	67	MAYO-HABERISSER Pince serre-fils	167
LEMPERT Raspatoires	40	MAYO-HEGAR Porte-Aiguilles	292
LEMPERT Rugines	40	MAYO-HEGAR Porte-Aiguilles PROMEDUR	286
LERICHE Pincés hémostatiques	260	MAYO-HEGAR Porte-Aiguilles PROMEDUR pour GAUCHERS	286
LERMOYEZ Trocarts pour sinus maxillaire	93	McDONALD Dissecteur / Elevateur	101
LeVASSEUR-MERRILL Ecarteur, fibre optique	160	McGEE Micro Crochets	61
LeVASSEUR-MERRILL Ecarteurs	160	McGEE Pince à plier le fil	52
LEWIS Râpes nasales	118	McINDOE Ciseaux à cartilages	141
LEXER-BABY Ciseaux à préparation PROMEDUR	231	McINDOE Ciseaux-burin	111
LEXER-MINI Ostéotomes	48	McINDOE Pince à dissequer PROMEDUR	251
LEYLA Spéculum auriculaire	18	McINDOE Pince coupante à os	69
LICHTWITZ Trocart pour sinus maxillaire	93	McINTOSH Laryngoscope à 3 spatules	187
LICHTWITZ-BIER Canules pour ponction	93	McINTOSH Laryngoscopes, FIBER OPTIQUE	187-188
Limes nasales	116	McINTOSH Laryngoscopes	179-182
LISTER-SINUS Pincés à tampons	275	McIVOR Ouvre-bouche	134
LITTAUER Pince à polypes auriculaires	31	McKENTY Septum Rugines	100
LITTAUER Pince à polypes nasaux	77	MERSHON Adapteur de couronnes	161
LITTAUER-LISTON Pince coupante à os	68	Mesureur, Rhinologie	121
LITTLEWOOD Pince à griffes pour tissus	267	METZENBAUM Ciseaux à préparation	228
LOCKLIN Ciseaux à préparation	89,92	METZENBAUM Ciseaux à préparation	228,229,230-231
LOCKLIN Ciseaux à préparation PROMEDUR	92	METZENBAUM Ciseaux à préparation PROMEDUR	232,233
LOPEZ-REINKE Dissecteurs pour amygdales	144	METZENBAUM Ciseaux pour GAUCHERS	228
LORNA Pincés pour champs en papier	273	METZENBAUM Porte-Aiguilles	292
LOVE Ecarteur nasopharyngal	142	METZENBAUM-BABY Ciseaux à préparation	228
LOVELACE Pincés hémostatiques	260	METZENBAUM-FINO Ciseaux	230,234-236
LUBET-BARBON Pince à polypes nasaux	77	METZENBAUM-FINO Ciseaux 14,5 cm cou. TC	234-236
LUC Pincés coupantes pour le nez	80	METZENBAUM-FINO Ciseaux à préparation PROMEDUR	234
LUCAE Aiguille pour le tympan	34	METZENBAUM-FINO Ciseaux SUPERCUT	230
LUCAE Couteau auriculaire	34	MICHEL Miroir Rhinoscopique	172
LUCAE Crochets auriculaires	36	Micro Crochets / Aiguilles, ORL	61,62
LUCAE Diapason réglable	22	Micro Curettes, ORL	65
LUCAE Marteau 19 cm 260 gr. Ø 25 mm	49, 114	MICRO Pince à dissequer	240
LUCAE Marteau, 19 cm 230 gr. Ø 19 mm	49, 114	MICRO Pincés à griffes	239
LUCAE Pincés auriculaires	33	MICRO Pincés auriculaires	50-52
LUCAS Ciseaux-burin 16 cm / 4 mm	46, 110	MICRO-ADSON Pincés à griffes	242
LUCAS Ciseaux-burin 16 cm / 6 mm	46, 110	Microchirurgie Endolaryngienne	198-203
LUCAS Gouge 16 cm / 3 mm	46, 110	Micro-Ciseaux	222-223
LUCAS Gouge 16 cm / 5 mm	46, 110	Micro-Ciseaux auriculaires	53-54
LUER Canules parlantes	206	Micro-Couteaux, ORL	59,60,65
LUER Canules tracheales	206	Micro-Elévateurs, ORL	65
LUER Ecarteur fin	280	MICRO-HALSEY Porte-Aiguilles PROMEDUR	285
LUER Pincés gouge	66	MICRO-HARTMANN Pincés hémostatiques	257
LUKENS Ecarteurs pour trachéotomie	210	MICRO-JACOBSON Pincés hémostatiques	258
LUNIATSCHEK Porte-tampon	144	Micro-Lames de bistouris	212
		Micro-Laryngo-Porte-Aiguilles	199
		MICRO-MOSQUITO Pincés hémostatiques	258
		Micro-Perforateurs	64
		Micro-Pincés auriculaires	50-52

	Page		Page
MILLER Laryngoscope	183	PARTSCH Gouges	46
MILLER Laryngoscopes, FIBER OPTIQUE	189,190	PARTSCH Maillet	49, 113
MILLER Râpes nasales	119	PASSOW Pylons pour hémostase	45
MILLER-BABY Laryngoscope	182	PEAN-FINO Pincés hémostatiques	263
MILLER-BABY Spatule FIBER OPTIQUE	190	PEARSON Pince-gouge	66
MILLES I Micro-Ciseaux	223	PECK-JOSEPH Ciseaux nasaux	88
MILLIGAN Ecarteur autostatique	57	PEERS Pince pour champs en papier	272
Mini Containers à stérilisation	308	PELKMANN Pincés porte éponges	276
MINI-GEMINI Pincés hémostatiques	265	PENNINGTON Pincés à griffes pour tissus	264
MINI-LANGENBECK Ecarteurs fins	281	PENNINGTON Septum Elevateur	102
MINI-LEXER Ostéotomes	48	Periostotomes maxillofacial	162,163
Miroir frontal	13	PERKINS Ecarteurs autostatiques	58
Miroirs laryngiens	172	PERWITZSCHKY Ciseaux pour voie salivaire	126
Miroirs rhinoscopique	172	PETRI Boîte ronde	318
MIXTER Ciseaux délicats	226	PIERCE Septum Elevateur	102
MIXTER-BABY Pincés hémostatiques	266	PIERCE Trocarts pour sinus maxillaire	93
MOBERG Ecarteur	279	PIFFARD Curettes auriculaires	35
MOBERG Ecarteurs fins à main	279	Pylons pour hémostase	45
MOBERG Ostéotomes	111	Pince à introduire prothèses	52
Mobilisateur	168	Pince à mors parallèles pour fils	38
MOLDENHAUER Levier pour corps étrangers	35	Pince coupante sur les côtes	38,166
MOLLISON Ecarteur autostatique	57	Pince écraseuse de la cloison nasale	123
MOSQUITO Pincés hémostatiques	258	Pince pour fixer implants nasals	107
MOSQUITO Pincés hémostatiques pour GAUCHERS	258	Pince pour l'attique	87
MOSQUITO-MICRO Pincés hémostatiques	258	Pince pour ouvrir les bouteilles	301
MYLES Pincés coupantes pour le nez	81	Pince pour sinus maxillaire	87
		Pince tire-langue	138
		Pincés	237-253
		Pincés à amygdales	138-140
		Pincés à champs	272-273
		Pincés à champs pour champs à papier	272,273
		Pincés à corps étrangers, ORL	31
		Pincés à déchets	300
		Pincés à dissequer	244
		Pincés à dissequer FINO	244
		Pincés à dissequer PROMEDUR	250
		Pincés à dissequer USA Model	244
		Pincés à griffes	245
		Pincés à griffes FINO	245
		Pincés à griffes pour tissus	264,267-269
		Pincés à griffes USA Model	245
		Pincés à intubation	138
		Pincés à ligatures	253
		Pincés à microscopie	240
		Pincés à os	68-69
		Pincés à pansement	276
		Pincés à pansement, porte-tampons	275-276
		Pincés à pansement, RHINOLOGIE	77,78
		Pincés à plier les fils d'acier	52
		Pincés à préhension	267-269
		Pincés à préhension pour sinus	80
		Pincés à réduction, mobilisation	169
		Pincés à stérilisation	300
		Pincés à tampons avec éprouvette et couvercle	319
		Pincés à traire les drains	274
		Pincés auriculaires	32,33
		Pincés broncho-esophagiennes	177
		Pincés coupantes, Rhinologie	79-85
		Pincés coupe-fils	38
		Pincés délicates pour Laryngoscopie	198,199
		Pincés emporte-pièces	86,87
		Pincés emporte-pièces circulaires	85
		Pincés fixe-toiles	314
		Pincés gouge	66-67
		Pincés hémostatiques	140,257-266
		Pincés hémostatiques BULLDOG	256
		Pincés hémostatiques et à préparation	255-266
		Pincés hémostatiques pour GAUCHERS	258
		Pincés interchangeables, Laryngo-, Broncho	176
		Pincés laryngiennes	173-176
		Pincés porte éponges	275,276
		Pincés porte tampons	275
		Pincés pour amygdales	84
		Pincés pour champs en papier	272,273
		Pincés pour la cloison nasale	123
<b>N</b>			
NAGER Aiguilles à ligatures, amygdales	145		
NAGER Releveur du voile du palais	142		
NEGUS Pincés à amygdales	139		
NEGUS Support pour Ouvre-bouche	137		
NEIVERT Crochet pour les ailes du nez	105		
NEIVERT Porte-Aiguilles	292		
NEIVERT Porte-Aiguilles PROMEDUR	286		
NEIVERT-ANDERSON Osteotomes	109		
NEUROTONE-5 Diapason	22		
NEW ORLEANS Porte-Aiguilles PROMEDUR	287		
NEWS Ecarteurs pour trachéotomie	210		
NOYES Pincés à polypes nasaux	77		
<b>O</b>			
OBWEGESER Alène manibulaire	166		
OBWEGESER Alène pour arcades cygomatiques	166		
OBWEGESER Ecarteur fixe-menton	156		
OBWEGESER Ecarteur pour ramus	154		
OBWEGESER Ecarteur pour spina nasalis	154		
OBWEGESER Ecarteurs mandibulaires	156		
OBWEGESER Ecarteurs pour parties molles	153		
OBWEGESER Ostéotomes	165		
OBWEGESER Periostotomes	162,163		
OBWEGESER Pince pour anses	166		
OBWEGESER Raspatoire maxillofacial	162		
OBWEGESER-FREER Elevateur maxillofacial	161		
OEHLER Pincés à dissequer PROMEDUR	252		
OLSEN-HEGAR Porte-Aiguilles	293		
OLSEN-HEGAR Porte-Aiguilles PROMEDUR	289		
ORINGER Ecarteurs des lèvres	131		
ORL Trousses Diagnostiques	9-12		
Ostéotomes maxillofacial	164		
Ostéotomes, ORL	47,48		
Ostéotomes, Rhinologie	108-112		
OSTROEM Pincés pour sinus maxillaire	84		
Otologie	15-70		
Otoscopes	9-12		
Ouvre-bouche	128,132-137		
Ouvre-bouteilles	301		
<b>P</b>			
Panier avec couvercle	309		
Paniers grillagés pour stérilisation	303,305,307,309,311		
Paniers pour Endoscopie	310		
PAREL Intranasal Porte-Aiguilles PROMEDUR	290		
PARTSCH Ciseaux-burin	46		

	Page		Page
Pincés pour Laryngo-Bronchoscopie	178	ROSE Ecarteurs pour trachéotomie	210
Pincés pour Micro-Laryngologie	203	ROSEN Canules à aspiration	27
Pincés pour os ethmoïdaux	83	ROSEN Couteaux à incision	59
Pincés pour saisir le tissu	207	ROSEN Couteaux circulaires	60
Pincés pour sinus maxillaire	84	ROSEN Micro Couteau	65
Pincés pour vomer	80	ROSEN Micro Curette	65
Pincés presse-tube avec protecteur	274	ROSEN Micro Elévateurs	65
Pincés presse-tubes	274	ROSEN Micro-Aiguille	62
Pincés serre-fils	167	ROSEN Mobilisateur	65
Pincés serre-fils automatique	167	ROSENBERG embout interchangeable	176
Pincés-ostéotome	87	ROSER-KOENIG Ouvre-bouche	128
Plaquettes d'identification	311	ROWE Pincés à réduction	169
Plateaux à instruments	321	RUBIN Ostéotomes	110
PLESTER Canules à aspiration	26	RUBIN Pince écraseuse de la cloison nasale	123
PLESTER Couteau à lambeaux	59	Rugines nasaux	103
PLESTER Crochet pour la platine de l'étrier	62	Rugines, ORL	40,41
PLESTER Ecarteurs autostatiques	56	RUMEL Pincés hémostatiques	265
PLESTER Ecarteurs autostatiques	58	RUSSEL-DAVIS Abaisse-langue	136
PLESTER Guide à fils	62	RYDEL-SEIFFER Diapason	22
PLESTER Rugine	62		
POLITZER (Buck) Furonculotome	34	<b>S</b>	
POLITZER Couteaux auriculaires	34	SAUERBRUCH Boîte à aiguilles	318
POLITZER Speculums auriculaires	16	SAUERBRUCH Pince à déchets	300
POOLE Canules à aspiration	298	SAWTELL (George)Pince à amygdales	139
Porte-Aiguilles	283-293	SAWTELL Pincés à amygdales	139
Porte-Aiguilles pour GAUCHERS	286	Scellés de sécurité. Plastique	311
Porte-Aiguilles PROMEDUR	284-290	SCHAEDEL Pince à champs	272
Porte-Aiguilles, Microlaryngologie	199	SCHEINMANN embout interchangeable	175
Porte-fibre pour Spatules	193	SCHIMMELBUSCH Boîtes rondes à stérilisation	316
Portes-coton	25	SCHMEDEN Pince coupante pour le nez	81
Portes-pincés	320	SCHNIDT Pincés à amygdales	139
Porte-tampons	144	SCHOEMAKER Ciseaux pour goitre	208
POST-MORTEM Lames de bistouris	217	SCHOENBORN crochet pour thyroïde	210
POTTS-SMITH Pincés à dissequer	246	SCHUKNECHT Couteau Serpette	59
POTTS-SMITH Pincés à dissequer PROMEDUR	250	SCHUKNECHT Ecarteur autostatique	58
POTTS-SMITH Pincés à griffes	248	SCHUKNECHT Micro-Couteaux auriculaires	59
Poubelles pour coton	317	SCHUKNECHT Pince à plier les fils d'acier	52
PRATT Curette pour l'antré	121	SCHUMACHER embout interchangeable	176
PRESBYTERIAN Pincés presse-tube	274	Scies nasales	120
PRINCE Ciseaux pour amygdales	141	SEBILEAU Elevateur	39
PRO-MED Pince pour fixer implants nasals	107	SEIFFERT embout interchangeable	175
PRO-MED Porte-Aiguilles PROMEDUR	290	SEIFFERT Sonde pour voie salivaire	94
Protecteur pour scies nasales	121	SELDIN Elevateur maxillofacial	161
PROVIDENCE-HOSPITAL Pincés hémostatiques	259	SELECT Pincés à microscopie	240
		SEMKEN Pincés à dissequer PROMEDUR	250
<b>Q</b>		SEMKEN Pincés à griffes	243
QUIRE Pince pour corps étrangers	31	SENN-GREEN Ecarteurs fins à main	281
		SENN-MILLER Ecarteurs fins à main	280
<b>R</b>		SENN-MILLER-BABY Ecarteurs fins à main	280
RAGNELL Ecarteur fin	280	Septum Elevateurs	100-103
RAGNELL RAGNELL (Kilner) Ciseaux PROMEDUR	231	Seringues à irrigation	23
Ramus Ecarteurs	154,155	Seringues auriculaires	24
Ramus-Ciseaux-burin	164	Serre-noeud pour amygdales	148
Ramus-Ostéotomes	164	Serre-noeuds nasaux	76
RANKIN-CRILE Pincés hémostatiques	261	SEXTON Couteau auriculaire	34
RANKIN-KELLY Pincés hémostatiques	261	SHAMBAUGH-DERLACKI Elevateur	39
Râpes nasales	115-118	SHAPLEIGH Curettes auriculaires	35
Raspatoire maxillofacial	162	SHEA Ecarteur pour usage universelle	160
Raspatoire, ORL	40,41	SHEA Micro Curettes	65
Raspatoires du palais	163	SHEA-BELLUCCI Micro-Ciseaux auriculaires	54
Récipients cylindriques	320	SHEEHAN Ostéotomes	112
REICHERT Depresseur de l'epiglotis	174	SIEBENMANN Canule aspiratrice	96
REINER-ALEXANDER Seringues auriculaires	24	SIEGLE Spéculum auriculaire	19
Ressorts spiraux	314	SILVER Ostéotomes	109
REYNOLDS Ciseaux à préparation	88	SLUDER-BALLENGER Amygdalalotome	149
REYNOLDS Ciseaux à préparation SUPERCUT	88	Sonde pour Microlaryngology	200
Rhinologie	71-126	Sondes à goitre	208
RICHNAU-HOLMGREN Speculums auriculaires	17	Sondes auriculaires	26
RING Abaisse-langue	136	Sondes auriculaires et nasales	296
RITTER-HALLE Bougies pour Sinus frontal	94,296	Sondes boutonées	296
ROCHESTER-PEAN Pincés hémostatiques	263	Sondes cylindriques	296
ROEDER Serre-noeud pour amygdales	148	Sondes de mesure	65
ROGER Elevateur	100	Sondes nasales	102
ROGGE Pince à stérilisation	300	Sondes pour sinus maxillaire	122



	Page		Page
Speculums auriculaires	16-19	<b>V</b>	
Spéculums nasaux	72-75	VANNAS Micro-Ciseaux	223
SPRAGUE Trousse auriculaire	34	VIENNA Speculum nasal modele leger	72
ST.CLAIR-THOMSON Couteaux à végétations adénoides	125	VIENNA Spéculums nasaux	72
STACKE Sonde auriculaire	25, 296	WISE Micro-Pinces à ligatures	253
STAMMBERGER Pinces emporte-pièce circulaires	85	VOLKMANN Curettes tranchantes	44
STEINHÄUSER Ecarteur zygomatique	152	VOLTOLINI Spéculums nasaux	75
STEINHÄUSER Ramus-Ciseaux-burin	164	<b>W</b>	
STEINHÄUSER Ramus-Ostéotomes	164	WAGENER Crochets auriculaires	36
STELLBRINK Pinces-Gouge	67	WALKER Iris-Ciseaux	225
Stérilisation	299-316	WALSHAM Pinces pour la cloison nasale	123
STERNBERG Ecarteurs à joues	131	WALTER Ciseaux-burin	110
STEVENS Ciseaux fins	226	WALTER Ecarteur nasal	106
STEVENS Ciseaux fins SUPERCUT	226	WALTER Ostéotomes	110
STILLE Pinces à dissequer	244	WALTON Pinces porte éponges	275
STRANDELL-STILLE Ecarteurs	279	WANGENSTEEN Pinces à dissequer PROMEDUR	250
STRINGER Etriers pour instruments	301	WATSON-CHEYNE Elevateur	101
STRUEMPPEL Pinces auriculaires	32	WATSON-CHEYNE Sondes nasales	102
STRUYCKEN Pinces coupantes pour le nez	81	WATSON-WILLIAMS Pince à saisir	79
Stylets	296	WATSON-WILLIAMS Pinces coupantes pour le nez	81
Stylets auriculaires et nasales	296	WATSON-WILLIAMS Pinces pour cloison nasale	79
Support pour Ouvre-bouche	137	WAUGH Pince à dissequer	247
Suture	283-293	WEBSTER Porte-Aiguilles	291
<b>T</b>		WEBSTER Porte-Aiguilles PROMEDUR	285
TABB Couteau Serpette	59	WEIL-BLAKESLEY Pinces coupantes pour le nez	82,83
TAKAHASHI Pinces pour os ethmoïdaux	83	WHITE Pinces à amygdales	139
Tapis port-instruments Silicone	313	WHITEHEAD Ouvre-bouche	132
TAYLOR Pinces à dissequer	247	WIBERG Rugines nasaux	103
TAYLOR Pinces à griffes	248	WIEDER Abaisse-langue	130
TAYLOR-CUSHING Pinces à dissequer	247	WIENER Râpes nasales	118
TAYLOR-CUSHING Pinces à griffes	248	WILDE Pince auriculaire	33
TESSIER Mobilisateur	168	WILDE Serre-noeuds nasal	76
TESSIER Osteotomes	165	WILDE Serre-noeuds pour polypes	37
TESSIER Raspatoires	162	WILLIGER Curettes auriculaires	43
THIESS Maillet	49, 113	WILLIGER Ecarteurs auriculaires	36
THUDICHUM Spéculums nasaux	75	WILLIGER Elevateurs	39
Thyroidectomie Instruments	207-208	WILLIGER Maillet	49, 113
TIECK-HALLE Spéculums nasaux	73	WILLIGER Rugines	40
Tige à nettoyage pour FRAZIER/FERGUSON	30	WISCONSIN-FOREGGER Laryngoscopes	185
Tige à nettoyage pour MAGILL	96	WULLSTEIN Canules à aspiration	26
Tige support pour enfants	195	WULLSTEIN Couteau Serpette	59
TILLEY Pince à pansements	31	WULLSTEIN Ecarteurs autostatiques	57
TILLEY-HENCKEL Pince ethmoïdale	84	WULLSTEIN Micro Canules aspiratrice	29
TIVNEN-TYDING Pinces à amygdales	140	WULLSTEIN Micro-Ciseaux auriculaires	53
TOBOLD Abaisse-langue	129	WULLSTEIN Micro-Pinces auriculaires	50
TOENNIS-ADSON Ciseaux à préparation PROMEDUR	232	<b>X</b>	
TOHOKU Pince à champs	273	YANKAUER Aiguilles à sutures	107
TOYNBEE Speculums auriculaires	16	YANKAUER Tubes d'aspiration	297
Tracheotomie, Goitre	205-210	YASARGIL Micro-Ciseaux	223
Transformateur pour CLAR	13	YOUNG Pince tire-langue	138
Trépan, ORL	64	<b>Z</b>	
Trocart pour sinus maxillaire	93	ZAUFAL Levier auriculaire	35
TROELTSCH Pince à Dissection	78	ZAUFAL Levier pour corps étrangers	36
TROELTSCH Pince à pansements	78	ZAUFAL-JANSEN Pince-Gouge	67
TROELTSCH Pinces auriculaires	33	ZAUFAL-JANSEN Crochet auriculaire	36
TROELTSCH Sondes auriculaires	26	ZIEGLER Mirroir frontal	13
TROUSSEAU Dilatateur pour la Trachéotomie	207	ZIEGLER Pince coupe-fil PROMEDUR	167
Tube aspiratrice nasale	95	ZOELLNER Canules à aspiration	27
Tubes à aspiration broncho-oesophagiennes	177	ZOELLNER Speculums auriculaires	17
Tubes aspiratrices	94-96		
Tubes aspiratrices, RHINOLOGIE	94-96		
Tubes d'aspiration	297,298		
Tubes-rallonge, Laryngoscopie	175		
TUFFIER Pince à griffes pour tissus	264		
TYDING Serre-noeud pour amygdales	148		
TYDING Bistouri à agygdales	147		
<b>U</b>			
UCKERMANN Porte-coton	25		
UCKERMANN Trachéotomes	207		
UNIV.MINNESOTA Abaisse langue	129		
UNIVERSAL Ciseaux à fils PROMEDUR	37		
USA-MODELE Pinces presse-tube	274		

# INDICE ALFABETICO

## A

Abaja-lenguas	128-131
Abaja-lenguas para Anestesia	132-136
ABRAHAM Cuchillo para amígdalas	147
Abre-bocas	128,131,132-136
Abre-bocas para Anestesia	132-135
ADSON Pinza de disección	241-243
ADSON Pinzas de disección PROMEDUR	250
ADSON Pinzas delicadas PROMEDUR	250
ADSON Pinzas hemostáticas	262
ADSON-BABY Pinzas hemostáticas	262
ADSON-BROWN Pinza de disección PROMEDUR	252
ADSON-DEBAKEY Pinzas atraumáticas	241
ADSON-GRAEFE Pinza para coger tejidos	243
ADSON-MICRO Pinzas delicadas	241
Agujas maxilar	166
Agujas para ligaduras y amígdalas	145-146
Agujas para suturas, RINOLOGIA	107
Alambre, acero para Polipotomos auriculares	37
Alambre, asas per Cierra-nudos	148
Alambre-limpieza para FRAZIER/FERGUSON	30
Alambre-limpieza para MAGILL tubos	96
Alicate para alambres	39
Alicates para cortar alambre PROMEDUR	38,166
ALLIS Pinzas para coger tejidos	264
ALLIS Pinzas para tejidos y organos atraumáticas	267
ALLIS-ADAIR Pinza para tejidos y organos	267
ALLIS-BABY Pinzas para coger tejidos	264
ALLPORT Ganchito auricular	36
ALLPORT Separador autostático	56
ALM Separadores autostáticos	55
ALM-MODIF. Separadores autostáticos	56
Amígdalótomos	149
ANDREW abaja-lenguas	129
ANDREW-PYNCHON Tubo de aspiración	297
Anses auriculares	35
ANTRUM Cucharilla para el antro	122
ANTRUM Cucharillas para seno	121
ANTRUM Cuchillos	97
Apoyo-pecho con pertiga p. Laringoscopios	195
Apoyos con resorte spiral	314
Asas de alambre para Cierranudos nasales	76
Asas de alambre para Polipotomos auriculares	37
ASCH Pinza para el tabique nasal	123
AUFRIEHT Escofinas nasales	118
AUFRIEHT Ganchos para las coanas	105
AUFRIEHT Tijeras nasales	91
AUSTIN Cinceles, MICRO-OTOLOGIA	64
AUSTIN Cuchillos de discision, MICRO-OTOLOGIA	59
AUSTIN Pinzas para ligaduras	253
AUTOFILL Jeringa para irrigación	23

## B

BABCOCK Pinzas para tejidos y organos	268
BABCOCK Pinzas para tejidos y organos PROMEDUR	268
BABCOCK-DEBAKEY Pinzas atraumáticas	268
BABY-ADSON Pinzas hemostáticas	262
BABY-ALLIS Pinzas para coger tejidos	264
BABY-CRILE Pinzas hemostáticas	259
BABY-CRILE-WOOD Porta-agujas PROMEDUR	286
BABY-LEXER Tijeras finas PROMEDUR	231
BABY-METZENBAUM Tijeras para preparaciones	228
BABY-MIXTER Pinzas hemostáticas	266
BABY-SENN-MILLER Ganchos y Separadores	280
BACKHAUS Pinzas para campo	272
BACKHAUS Pinzas para campo con porta-tubo	272
BALL e SOCKET Pinzas para campo	273
BALLENGER Bisturi para el cartilago	97
BALLENGER Cuchillos para el tabique nasal	99
BALLENGER Elevadore	101
BALLENGER Pinza para amígdalas	140
Bandejas para instrumentos	321

Bandejita para tabletas	320
BARANY Ensordecedor	22
BARBARA Microagujas auriculares	61,62
BARNHILL Cuchillos p.vegetaciones adenoideas	125
BARON Sondas irrigadoras	94
BARRON Mango de bisturis	216
BARSKY Ganchito para piel	105
BAUER Separadores intra orales	157
BAUER Separadores intra orales con luz fria	157
BAUMGARTNER Porta-agujas	291
BAUMGARTNER Porta-agujas PROMEDUR	285
BECKMAN Espéculos nasales	73
BECKMANN (Negus) Cuchillos p.vegetaciones adenoideas	124
BECKMANN Cuchillos p.vegetaciones adenoideas	124
BEEBEE Tijeras para hilos	38
BELLUCCI Microtijeras auriculares	53
BERNHARD Pinza para campo	273
BEYER Pinza para el ático	87
BEYER Pinzas-gubias	66,67
BILLEAU Anses auriculares	35
Bipod para abre-bocas	137
BIRKETT Pinzas hemostáticas	140
BISHOP Separador para labios	131
Bisturis para amígdalas	147
Bisturis para Microlaringlogia	200
BISTURIS, HOJAS Y MANGOS	212-219
BLANK Pinzas de disección atraumáticas	244
BLOHMKE Pinza para amígdalas	140
BOCA Y LENGUA, AMIGDALECTOMIA	127-149
BOEHLER Pinzas cortantes para huesos	69
BOEHLER Pinzas-gubias	67
BOETTCHER Tijeras para amígdalas	141
BOIES Elevador para fracturas nasales	107
BONNEY Pinza de disección PROMEDUR	251
BONNEY Pinza de disección PROMEDUR	252
BOSE Ganchitos para traqueotomia	209
BOSE Separador autostático	55,207
BOSWORTH Abaja-lenguas	130
BOUCHERON Espéculos auriculares	16
BOWMAN Estiletos exploradoras	296
BOYS-ALLIS Pinza para tejidos y organos	267
BROMPTON Pinza para drenaje tubos	274
BROPHY Pinzas de disección	244
BROPHY quirúrgicas de disección	247
BRUENINGS Cierra-nudos tonsilar, para amígdalas	148
BRUENINGS Cuchillo para amígdalas	147
BRUENINGS Espéculos auriculares neumáticos	19
BRUENINGS Pinzas cortantes para.la nariz	79
BRUENINGS Pinzas intercambiables	175
BRUENINGS Septatomo regulable	99
BRUENINGS Tubos alargaderos	175
BRUENINGS-BRUNK Separador para el seno maxilar	94
BRYANT Pinza para curaciones	275
BÜCHS Separador para mejillas	152
BUCHWALD Abaja-lenguas	129
BUCK Curetas auriculares	42
BUCK Pinza para cuerpos extra?os	31
BUCKINGHAM Micro-Cinzel, MICRO-OTOLOGIA	64
BUCKINGHAM Trepanos, MICRO-OTOLOGIA	64
BUCKLEY Cinceles	45
BUNT Porta-instrumentos	301

## C

Cajas de esterilización para Micro-Instrumentos	316
Cajas de esterilización y accesorios	302,304,306,308,310,316
Cajas para instrumentos	321
Cajedin clasificador de identificación	311
CANFIELD Cuchillo para amígdalas	147
Cánulas aspiradoras	26-30
Cánulas aspiradoras conical	27
Cánulas aspiradoras para Bronco-Esofagoscopia	177
Cánulas Traqueales	206
Cánulas Traqueales parlantes	206
CAPLAN Tijeras para nariz	92

	Página		Página
CARPENTER Disecadores tonsilares	144	CRILE-WOOD Porta-agujas	292
CARREL Pinza hemostática	257	CRILE-WOOD Porta-agujas PROMEDUR	286
CASTELNUOVO Sondas doble para el seno frontal	122	CRILE-WOOD Porta-agujas PROMEDUR para ZURDOS	286
CASTROVIEJO Micro Porta-agujas	284	CRILE-WOOD-BABY Porta-agujas PROMEDUR	286
CASTROVIEJO Micro Porta-agujas PROMEDUR	284	Cubetas	319
Cestas de esterilización	303,305,309,309,311	Cuchara para medicinas	320
CHAPUT Pinza para coger tejidos	264	Cucharillas cortantes, OTOLOGIA	42-44
CHEATLE Pinzas para esterilización	300	Cucharillas para seno	121,122
CHEVALIER-JACKSON Pinzas laringo-brochoscópicas	177	Cucharillas, RINOLOGIA	121,122
CICHERELLI Pinzas-gubias	66	Cuchillos auriculares	34
Cierranudos nasales	76	Cuchillos para amígdalas	147
Cierra-nudos tonsilar, para amígdalas	148	Cuchillos para el tabique nasal	99
Cinceles hemostáticos	45	Cuchillos, MICRO-OTOLOGIA	59-60,65
Cinceles para huesos, OTOLOGIA	46,47,48	Cuchillos, RINOLOGIA	97-99
Cinceles, CIRUGIA ORAL	164	Curetas auriculares	35
Cinceles, OTOLOGIA	45,46,47,48	Curetas auriculares	42-44
Cinceles, RINOLOGIA	108-111	Curetas para el antro	121
CINELLI Osteótomos, RINOPLASTIA	111	CUSHING Pinza de disección	246
CINELLI Tijeras nasales	90	CUSHING Pinzas de disección PROMEDUR	250
CIRUGIA CRANEO-MAXILOFACIAL	151-169	CUSHING Separadores	281
CITELLI Pinzas-osteótomo	87	CUSHING-LANDOLT Espéculos nasales	75
Clamps "BULLDOG"	256		
CLAR Espejo frontal	13,14	<b>D</b>	
CLAR Espejo frontal LUZ FRIA	14	DANDY Pinzas hemostáticas	260
CLAUS-EICKEN Aguja para amígdalas	145	DANDY-MOSQUITO Pinza hemostática	260
CLEVELAND Pinzas cortantes para huesos	68	DANIELS Amígdalótomos	149
COAKLEY Curetas para el antro	121	DAUGHTY (WÜRZBURG) Abaja-lenguas	135
COAKLEY Trócares para el seno maxilar	93	DAVIS Pinzas para esterilización	300
COLLER-CRILE Pinzas hemostáticas	261	DAVIS-BOYLE Abre-bocas	132
COLLIER Porta-agujas	291	DAVIS-MEYER Abre-bocas	133
COLLIN Mangos de bisturis	215,218	DAY Ganchos auriculares	36
COLLIN Pinza para tejidos y organos	269	DEAN Cuchillo para amígdalas	147
COLLIN Pinza tira-lenguas	138	DEAN Tijeras	141
COLVER Pinzas para amígdalas	140	DEAN Tijeras nasales PROMEDUR	92,141
Contenedores "Endoscopia" para esterilización	310	DEBAJKEY-BABCOCK Pinzas para tejidos y organos	268
Contenedores planos para esterilización	308	DEBAKEY Pinzas atraumáticas	248,249
CONVERSE Chuchillo para rinoplastia	98	DEBAKEY Pinzas atraumáticas	248,249
CONVERSE Separador nasal	106	DEBAKEY Pinzas atraumáticas PROMEDUR	251
CONVERSE-ALAR Gancho para las alas de la nariz	106	DEBAKEY-ADSON Pinzas atraumáticas	241
Copas graduadas	318	DEBAKEY-GERALD Pinzas de disección atraumáticas	246
COPE Separador	281	DEBAKEY-SELECT Porta-agujas DIAMANTE	287
CORDES Pinzas intercambiables	176	DENHARDT Abre-boca	128
COTTLE (Millard) Ganchito forma de anillo	106	Depresor para epiglotis	174
COTTLE Bisturis para el tabique nasal	98	DERF Porta-agujas	291
COTTLE Cincel; RINOLOGIA	108,110,111	DERF Porta-agujas PROMEDUR	285
COTTLE Cinceles, RINOPLASTIA	110	DIAGNOSTICO	7-14
COTTLE Elevador nasal	101	Diaposanes	20-22
COTTLE Escofina nasal	118	DIETER Pinzas sacabocado MICRO-OTOLOGIA	52
COTTLE Espéculos nasales	74	DIETRICH Clamps Bulldog	256
COTTLE Gancho para la nariz	105	Dilatadores para el seno frontal	94,296
COTTLE Gancho para las coanas	105	Dilatadores para la traquea	207
COTTLE Ganchos para las alas de la nariz	104	DINGMAN Abre-bocas	134
COTTLE instrumento de aplicación	107	DINGMAN Elevadores zigomáticos	161
COTTLE Machacadera de cartilago	107	DINGMAN Ganchos zigomáticos	160
COTTLE Martillo	49, 114	Disecadores tonsilares	143,144
COTTLE Osteótomos	108	Disecadores, MICRO-OTOLOGIA	63
COTTLE pinza para cartilagos	78	Dispensores de algodón	317
COTTLE Pinza para columnella	78	Distribuidor de filtros	312
COTTLE Pinza para fijacion	78	DOCKHORN Separador para mejillas	152
COTTLE Separador	101	DOUGLAS Cuchillo para amígdalas	147
COTTLE-ALAR Separador para las alas nasales	106	DOYEN Abaja-lengua 16 cm	129
COTTLE-BULLDOG Tijeras nasales	90	DOYEN Porta-agujas	291
COTTLE-DORSAL Tijeras nasales	90	DOYEN-JANSEN Abre-bocas	128
COTTLE-KAZANJIAN Pinza cortante para huesos	68	DRAFFIN Bipod para abre-bocas	137
COTTLE-MASING Tijeras nasales	91	DUNHILL Pinzas hemostáticas	259
COUPLAND Tubo aspirador	95	DUPUY-WEISS Aguja para ligaduras y amígdalas	145
CRAIG Pinza para el vomer	80	DUVAL Pinzas para tejidos y organos	269
CRAIG Pinzas para el vómer	80	DUVAL Pinzas para tejidos y organos PROMEDUR	269
CRILE Pinzas hemostáticas	259		
CRILE Porta-agujas	292	<b>E</b>	
CRILE Separador doble	280	EICKEN-KILLIAN Sondas aspiradoras del seno maxilar	95
CRILE-BABY Pinzas hemostáticas	259	EICKEN-KILLIAN Sondas irrigadoras del seno maxilar	94,95
CRILE-COLLER Pinzas hemostáticas	261	Elevadores para el tabique nasal	100
CRILE-MURRAY Porta-agujas	292	Elevadores para huesos, OTOLOGIA	39
CRILE-RANKIN Pinzas hemostáticas	261		

	Página		Página
Elevadores para Microlaringología	200	FULLER Pinza para poner prótesis MICRO-OTOLOGIA	52
Elevadores para zigoma	162		
Elevadores zigomáticos	161	<b>G</b>	
Elevadores, RINOLOGIA	100	Ganchitos para Microlaringología	200
Elevadores auriculares	36	Ganchitos para traqueotomía	209-210
Ensordecedor	22	Ganchos para las coanas	105
Escofinas nasales PROMEDUR	115,117,119	Ganchos para mucosa	104
Escofinas, RINOLOGIA	115-119	Ganchos y erinas finas	278,279
Espéculos auriculares	16-19	Ganchos y ganchitos auriculares	36
Espéculos nasales	72-75	Ganchos y Separadores	278-281
Espejo frontal	13,14	Ganchos zigomáticas	160
Espejos laringeos y mangos	172	Ganchos, RINOLOGIA	104-106
Espejos rinoscópicos	172	GEMINI Pinzas hemostáticas	265
ESTERILIZACION	299-321	GEMINI-MINI Pinzas hemostáticas	265
Esterilización, Pinzas	300,301	GERALD Pinzas de disección	246
Estiletos auriculares y para seno Medelo francés	296	GERALD Pinzas de disección PROMEDUR	251
Estiletos exploradoras auriculares y para seno	296	GERALD quirúrgicas de disección	247
Estiletos para canal lacrimal	296	GEUDEL-NEGUS Laryngoscopios	186
ESTILETES; ASPIRACION; PUNCION; INYECCION	295-298	GILLIES Elevador zigomático	161
Estillette para el canal salivar	94	GILLIES Pinza de disección PROMEDUR	251
Estribos para instrumentos	301	GILLIES Pinza fina	243
Estrumectomia	207-208	GILLIES Porta-agujas	293
Estuches Diagnósticos	8-12	GILLIES Porta-agujas PROMEDUR	289
Estuches para agujas	317,318	GILLIES-MINI Porta-agujas	293
Etiquetas indicadoras, papel	311	GILLIES-MINI Porta-agujas PROMEDUR	289
EVES Cierra-nudos tonsilar, para amígdalas	148	GLASSMANN Pinzas atraumáticas	249
EWALD Pinzas delicadas	241,242	GOLDMAN-FOX Tijeras PROMEDUR	231
Extractor para quitar hojas de bisturi	219	GOLDMANN Elevador para fracturas	107
		GOOD Tijeras para amígdalas	141
<b>F</b>		GORNEY (Killian) Tijeras para nariz	92
FALK Agujas para ligaduras y amígdalas	146	GORNEY Disecadore para aspiración	103
FARABEUF Periostótomos	41	GORNEY Tijeras para Face-Lift	141
FARRELL Porta- algodones	25	GORNEY Tijeras para Face-Lift SUPERCUT	141
FARRIOR Espéculos auriculares	17	GRAEFE Pinzas delicadas	238,239
FARRIOR Espéculos auriculares NEGRO	17	GRAEFE Pinzas delicadas	238
FAULKNER Cureta para el antro	121	GRAEFE Pinzas delicadas TITANIO	238
FAULKNER Gubia Antral	110	GRAEFE-SELECT Pinzas delicadas	238,239
FERGUSON Tubos de aspiración	30	GRAZIL Tijeras para cirugía general	227
FERGUSON Tubos de aspiración aislante	30	GREVEN Pinza prensora	51
Filtros, papel para esterilización	312	GROSS Cureta y Gancho, OTOLOGIA	35
Filtros, textil para esterilización	313	GROSS Instrumento para cuerpos extra?os	35
FINSEN Separadores autostáticos	55	GROSS Pinzas para pólipos	276
FISCH Cánulas de aspiración	28	GRUBER Espéculos auriculares	16
FISCH Disecadores, MICRO-OTOLOGIA	63	GRUENWALD (Jansen) Pinzas nasales	78
FISCH Perforadores, MICRO-OTOLOGIA	64	GRUENWALD Pinzas de disección, RINOLOGIA	78
FISH Sondas / Estiletas para exploración	25, 296	GUASTELLA-EY Osteótomos, RINOPLASTIA	109
FISHER Cuchillo para amígdalas	147	Gubias para huesos, OTOLOGIA	45,46,47,48
FOCUS Halogen-Lampara frontal	14	Gubias, RINOLOGIA	108,110
FOERSTER Pinzas porta-esponjas	275	GUILEN Legra de succión	95
FOMON Cinceles	109	GUILFORD Tijeras para hilos negro	38
FOMON Cuchillo para rinoplastia	97	GUNNAR-HEY Pinza para drenaje	274
FOMON Escofinas nasales	116		
FOMON Escofinas nasales PROMEDUR	117	<b>H</b>	
FOMON Gancho para las alas de la nariz	105	HAJEK Martillos	49, 113
FOMON Gancho doble con boton	105	HAJEK-BALLENGER Elevadores	101
FOMON Tijeras nasales	90	HAJEK-CLAUS Pinza para sinus maxillar	87
FOMON-DORSAL Tijeras nasales finas	89	HAJEK-KOFLER Pinzas saca-bocado para esfenoides	86
FOMON-DORSAL Tijeras nasales finas SUPERCUT	89	HALLE Elevador para el tabique nasal	100
FOSTER-GILLIES Porta-agujas PROMEDUR	288	HALSEY Porta-agujas PROMEDUR	285
FOWLER Cuchillo para amígdalas	147	HALSEY Porta-agujas PROMEDUR	291
FRAENKEL Pinzas intercambiables	175	HALSEY-MICRO Porta-agujas PROMEDUR	285
FRAENKEL Pinzas para pólipos laríngeos	173,174	HALSTED Pinzas hemostáticas	262
FRAZIER Tubos de aspiración	29,30	HALSTED-MOSQUITO Pinzas hemostáticas	258
FRAZIER Tubos de aspiración aislante	29	HARRISON Pinzas para esterilización	300
FRAZIER Tubos de aspiración para LUZ FRIA	29	HARTMANN Abaja-lenguas	130
FREER Bisturi para la mucosa	98	HARTMANN Diapasones	21
FREER Cinceles, RINOLOGIA	108	HARTMANN Espéculos auriculares	16
FREER Cuchillos para la naariz	99	HARTMANN Espéculos nasales	72
FREER Elevadores para el tabiquenasal	100	HARTMANN Pinza para ligaduras	257
FREER Gancho para la mucosa	104	HARTMANN Pinza para pólipos nasales	77
FREER Gubia	108	HARTMANN Pinza para tampones, RINOLOGIA	77
FREER-INGALS Cuchillo para submucosa	98	HARTMANN Pinzas auriculares	32
FRIEDMANN Pinza-gubias	66	HARTMANN Pinzas cortantes, RINOLOGIA	84
FRIEDMANN-MINI Pinza-gubias	66	HARTMANN Pinzas hemostáticas	257



	Página		Página
HARTMANN Pinzas para amígdalas	84	JOSEPH Elevador	101
HARTMANN Pinzas para el tabique nasal	84	JOSEPH Escofinas nasales	115
HARTMANN Pinzas per tamponiamentos auricular	31	JOSEPH Ganchos finos	104
HARTMANN Sondas auriculares	26	JOSEPH Ganchos para mucosa	104
HARTMANN Tubos de succión	27	JOSEPH Ganchos para mucosa	104
HARTMANN-HALLE Espéculos nasales	72	JOSEPH medidor	120
HARTMANN-MICRO Pinzas auriculares	50	JOSEPH Separador	102
HARTMANN-MICRO Pinzas hemostáticas	257	JOSEPH Sierras nasales	120
HARTMANN-WULLSTEIN Pinzas auriculares	51	JOSEPH-MASING Elevador	102
HARVEY Tijera para hilos	37	JUDD-ALLIS Pinzas para tejidos y organos	267
HASLINGER Separador para velor del paladar	142	JULIAN Porta-agujas PROMEDUR	287
HEERMANN Mango para fijar instrumentnos	201	JURASZ Pinzas bronco-esofagoscópicas	173
HEISTER Abre-bocas	128		
Hemostatica, Punzónes	45	<b>K</b>	
HENKE Disecadores tonsilares	143	KABIERSKE pulverizadores	24
HERZFELD Pinzas auriculares	32	KANTROWITZ Pinzas hemostáticas	265
HEUWIESER Pinzas para coger polypos	80	KAYE Porta-agujas PROMEDUR	289,290
HEYMANN Pinzas cortantes para.la nariz	79	KAYE-MILLARD Gancho "Facelift "	106
HEYMANN Tijeras nasales	89	KELLY Pinzas hemostáticas	259
Hilo para huesos	166	KELLY Tijeras finas	226
Hipofaringoscopia	192	KELLY-RANKIN Pinzas hemostáticas	261
HOFER Gancho para el paladar	142	KELSEY-FRY Agujas maxilar	166
HOFFMANN Pinza auriculare	32	KERRISON Pinzas saca-bocado para esfenoides	86
Hojas de bisturi	212,213,217	KILLIAN Canula lavadora	96
HOKE Osteótomos para huesos	47	KILLIAN Elevadores	102
HOLINGER Laringoscopia para operaciones	194	KILLIAN Espéculos nasales	73
HOLTZHEIMER Separadores autostáticos	56	KILLIAN-CLAUS Gubia nasal	108
HOUGH Sonda de medicion	65	KILNER Ganchos para las coanas	106
HOUSE Adapter Luer/Luer con interruptor	28	KILNER Porta-agujas PROMEDUR	285
HOUSE Cánulas de aspiración	28	KILNER Porta-agujas PROMEDUR	285
HOUSE Cucharillas cortantes	42	KILNER Porta-agujas PROMEDUR	291
HOUSE Separador doble	280	KILNER Tijeras nasales finas	91
HOWARTH (Burton) Elevador	102	KILNER-DAUGHTY Abaja-lenguas	135
HUBER Mango Universale	175	KIRSTEIN (Heymann) Tijeras nasales	89
HURD Agujas para ligaduras y amígdalas	146	KLAPP Ganchos y Separadores	279
HURD Disecadores tonsilares	143	KLING-EX Extractor-hojas	219
HYLIN legras	41	KNIGHT Pinza para pólipos nasales	77
		KOCHER Pinzas hemostáticas	263
<b>I</b>		KOCHER Sondas para bocio	208
INSTRUMENTOS GENERALES PARA ORL	211-298	KOCHER-FINO Pinza Pinzas hemostáticas	263
Instrumentos para cuerpos extra?os, OTOLOGIA	31,35,36	KOENIG Diapason ajustable	22
IRIS Tijeras finas	224-225	KOENIG Elevadores para huesos	39
IRIS Tijeras finas para ZURDOS	224	KOENIG legras	40
IRIS Tijeras finas PROMEDUR	231,232,234-236	KÖNIG Ganchos y Separadores	279
IRIS Tijeras finas SUPERCUT	224-225	KONRICH Cajas para esterilización	316
IRIS Tijeras PROMEDUR	231	KRAUSE Cierranudos, RINOLOGIA	76
ITERSON Ganchitos para traqueotomia	209	KRAUSE Pinzas intercambiables	176
		KRAUSE Polipotomo auricular	37
<b>J</b>		KRAUSE Trócar para el seno maxilar	94
JACKSON Cánulas aspiradoras p. Bronco-Esofagoscópia	177	KRAUSE-VOSS Cierranudos, RINOLOGIA	76
JACKSON Canulas Traqueales	206	KROENIG Abaja-lenguas	129
JACKSON Laringoscopios para operacioones	194	KUHN-BOLGER Cucharillas para el seno	121
JACKSON Pinzas bronco-esofagoscópicas	173		
JACKSON Separadores para traqueotomia	209	<b>L</b>	
JACOBSON-MICRO Pinzas hemostáticas	258	LABORDE Dilatador para la traquea	207
JAKO Bisturis laríngeos	201,202	LACK Abaja-lenguas	130
JAKO Disecador endolaríngeo	202	LA-FORCE Adenótomos	126
JAKO Gancho laríngeo	202	LAHEY Pinza para coger tejido	207
JAKO Sonda laríngea	202	LAHEY-METZENBAUM Tijeras para preparaciones	228
JAMESON Tijeras finas nasales	88	Lámpara frontal halógeno	14
JAMESON Tijeras finas SUPERCUT	88	LANDAU Trócar para el seno maxilar	93
JAMESON-WERBER Tijera finas	88	LANDOLD Mango para bisturis	212
JANSEN Cucharillas cortantes	43	LANE Pinza para campo	273
JANSEN Separadores autostáticos	56	LANGE Gancho para las coanas	105
JANSEN-MIDDLETON Pinzas para el tabique nasal	81	LANGE Pinza intercambiable	175
JEFFERSON Pinza de disección	243	LANGE Pinza para pólipos laríngeos	174
JENNINGS Abre-bocas	132	LANGENBECK Lazo auricular	35
Jeringas para irrigación	23,24	LANGENBECK Porta-agujas PROMEDUR	287
JOBSON-HORNE Porta-algodones	25	LANGENBECK-MINI Separadores finas	281
JONES Pinzas para campo	272	LARINGO-BRONCO-ESOFAGOSCOPIA	171-195
JOSEPH (Masing) Bisturi de la nariz	98	Laringo-Broncospopia, Pinzas	203
JOSEPH Bisturi para la nariz	98	LARINGOLOGIA	197-203
JOSEPH conductor para sierra	120	Laringoscopios	179-195
JOSEPH Cuchillos para la nariz	97	Laringoscopios para operaciones	191-194

	Página		Página
LAZAR Micro-Pinza para ligaduras	253	MAYO Abaja-lenguas	129
LE MEE Abaja-lenguas	130	MAYO Porta-Instrumentos	301
Legras para paladar	163	MAYO-HABERISSER Pinzas cierra-hilos	167
Legras, OTOLOGIA	40	MAYO-HEGAR Porta-agujas	292
Legras, OTOLOGIA	40,41	MAYO-HEGAR Porta-agujas PROMEDUR	286
LEMPERT Curetas auriculares	44	MAYO-HEGAR Porta-agujas PROMEDUR para ZURDOS	286
LEMPERT Elevadores para huesos	39	McDONALD Disecador	101
LEMPERT Legras	40	McGEE Micro-Ganchitos auriculares	61
LEMPERT Pinzas-gubias	67	McGEE Pinza para doblar alambra MICRO-OTOLOGIA	52
LERICHE Pinzas hemostáticas	260	McINDOE Cinceles, RINOPLASTIA	111
LERMOYES Trócares para el seno maxilar	93	McINDOE Pinza cortante para huesos	69
LeVASSEUR-MERRILL Separador extra-oral con luz fria	160	McINDOE Pinza de disección PROMEDUR	251
LeVASSEUR-MERRILL Separadores extra-orales	160	McINDOE Tijeras p. cirugía plastica	141
LEWIS Escofinas nasales	118	McINTOSH Laringoscopios	179-181
LEXER-BABY Tijeras finas PROMEDUR	231	McINTOSH Laringoscopios, luz fria	187,188
LEXER-MINI Gubias para huesos	48	McIVOR Abre-bocas	134
LEXER-MINI Osteótomos para huesos	48	McKENTY Elevadores, RINOLOGIA	100
LEYLA porta-Espéculos auriculares	18	Medidor, RINOLOGIA	120
LEYLA Porta-Espéculos auriculares suelto	18	MERSHON Empujador de coronas	161
LICHTWITZ Trócar para el seno maxilar	93	METZENBAUM Porta-agujas	292
LICHTWITZ-BIER Aguja/trócar para el seno maxilar	93	METZENBAUM Tijeras para preparaciones	228-230
LISTER-SINUS Pinzas para curaciones	275	METZENBAUM Tijeras para preparaciones PROMEDUR	232-233
LITTAUER Pinza para pólipos nasales	77	METZENBAUM Tijeras para preparaciones SUPERCUT	228-230
LITTAUER Pinza para tamponiamentos auricular	31	METZENBAUM Tijeras para ZURDOS	228,229
LITTAUER-LISTON Pinza cortante para huesos	68	METZENBAUM-BABY Tijeras para preparaciones	228
LITTLEWOOD Pinza para tejidos y organos	267	METZENBAUM-FINO Tijeras finas PROMEDUR	234-236
LOCKLIN Tijeras nasales	89	METZENBAUM-FINO Tijeras para preparaciones	230
LOCKLIN Tijeras nasales PROMEDUR	92	METZENBAUM-LAHEY Tijeras para preparaciones	228
LOPEZ-REINKE Disecadores tonsilar con aspiratore	144	MICHEL Espejos rinoscópicos	172
LORNA Pinza para campo para paños de papel	273	MICRO Pinzas delicadas	239,240
LOVE Separadores nasofaringeal	142	Micro Tijeras	222-223
LOVELACE Pinzas hemostáticas	260	MICRO-ADSON Pinzas delicadas	241
LUBET-BARBON Pinza para pólipos nasales	77	Microagujas auriculares	61,62
Lubricante para las instrumentos	317	Micro-cánulas aspiradoras	27
LUC Pinzas cortantes para la nariz	80	Micro-Cinceles, MICRO-OTOLOGIA	64
LUCAE Diapason ajustable	22	Microcirugía endolaringeal	198-203
LUCAE Ganchitos auriculares	36	Micro-Cucharillas, MICRO-OTOLOGIA	65
LUCAE Martillos	49, 114	Micro-Ganchitos auriculares	61,62
LUCAE Pinzas auriculares	33	MICRO-HALSEY Porta-agujas PROMEDUR	285
LUCAE Pinzas auriculares forme baioneta	34	Micro-Hojas de bisturi	212
LUCAS Cinceles, RINOLOGIA	46, 110	MICRO-JACOBSON Pinzas hemostáticas	258
LUCAS Gubias; RINOLOGIA	46, 110	Micro-Laringo-Porta-agujas	199
LUER Canulas Traqueales	206	MICRO-MARTMANN Pinzas hemostáticas	257
LUER Canulas Traqueales parlantes	206	MICRO-MOSQUITO Pinzas hemostáticas	258
LUER Pinzas-gubias	66	MICRO-OTOLOGIA	50-54,59-65
LUER Separador	280	Micro-Pinzas para Cirugia endolaringeal	198
LUKENS Separador para el timo	210	Microtijeras auriculares	53,54
LUNIATSCHEK Tamponeador	144	Micro-Tijeras para Cirugia endolaringeal	198
LUZ FRIA Mango 30 mm Ø	187,188,189,190	MILLER Escofinas nasales	119
		MILLER Escofinas nasales PROMEDUR	119
		MILLER Laryngoscopios	183,194
		MILLER Laryngoscopios, luz fria	189,190
		MILLER-BABY Laringoscopio	182
		MILLER-BABY Laringoscopio, luz fria	182,184
		MILLESI Tijeras para Microcirugia	223
		MILLIGAN Separador autostático	57
		MINI-Contenedores para esterilización	308
		MINI-LANGENBECK Separadores finas	281
		MIXTER Tijeras finas	226
		MIXTER-BABY Pinzas hemostáticas	266
		MOBERG Ganchos y Separadores	279
		MOBERG Osteótomos, RINOPLASTIA	111
		Mobilizadores	168
		MOLDENHAUER Elevador para cuerpos extra?os	35
		MOLLISON Separador autostático	57
		MOSQUITO Pinzas hemostáticas	258
		MOSQUITO Pinzas hemostáticas	258
		MOSQUITO-MICRO Pinzas hemostáticas	258
		MYLES Pinzas nasales cortantes	81
<b>M</b>		<b>N</b>	
MAGILL Pinza para cateteres	138	NAGER Aguja para ligaduras y amigdalas	145
MAGILL Tubos de aspiración	96	NAGER Separador para velor del paladar	142
MALTZ Cuchillo para la nariz	98	NEGUS Pinzas para amigdales	139
MALTZ Escofina nasal n	115		
MALTZ Separador para la nariz	105		
MALTZ-TC Escofinas nasales PROMEDUR	115		
Mangos para bisturis	212,214-216,218-219		
Mangos para espejos laringeos	172		
Mangos para fijar instrumentnos	201		
Mangos para Micro-bisturis	212		
Martillo con tapas de Nylon	49, 114		
Martillos	49, 113		
MARTIN Pinza para desechos	300		
MARTINI Cucharillas cortantes	42		
MASING Elevador per il setto	101		
MASTIN Pinza para músculos	207		
MATHIEU Ganchos y Separadores	280		
MATHIEU Porta-agujas	293		
MATHIEU Porta-agujas PROMEDUR	288		
MATHIEU-KOCHER Porta-agujas PROMEDUR	288		
MATHIEU-SLIM Porta-agujas	293		
MAUNDER Garrote, madera	128		
MAYFIELD Pinza-gubias	67		

	Página		Página
NEGUS Soporte para abre-bocas	137	PINZAS	237-253
NEIVERT Gancho para las coanas	105	Pinzas auriculares	32,33
NEIVERT Porta-agujas	292	Pinzas auriculares angolate	33
NEIVERT Porta-agujas PROMEDUR	286	Pinzas auriculares forme baioneta	34
NEIVERT-ANDERSON Osteótomos, RINOPLASTIA	109	Pinzas cierra-hilos	167
NEUROTONE-5 Diapason	22	Pinzas cortantes circular	85
NEW ORLEANS Porta-agujas PROMEDUR	287	Pinzas cortantes para huesos	68-69
NEWS Separador para traqueotomía	210	Pinzas cortantes para la nariz	79-87
NOYES Pinza para pólipos nasales	77	PINZAS DE CAMPO, PARA TUBOS Y TAMPONES	271-276
<b>O</b>		Pinzas de disección	244
OBWEGESER Aguja mandibular	166	Pinzas de disección PROMEDUR	250
OBWEGESER Gancho para el mentón	156	Pinzas delicadas	238-243
OBWEGESER Lezna para arcos zigomáticos	166	Pinzas en forme de bayoneta	246,247,248
OBWEGESER Osteótomos, CIRUGIA ORAL Y MAXILOF.	165	Pinzas hemostáticas	140
OBWEGESER Periostótomos	162	Pinzas hemostáticas para ZURDOS	258
OBWEGESER Periostótomos	162,163	PINZAS HEMOSTATICAS Y PARA PREPARACIONES	255-269
OBWEGESER Pinza para ases	166	Pinzas intercambiables bronco-esofagoscópicas	175-176
OBWEGESER Separadores acanalados	156	Pinzas laringo-broncoscópicas	178
OBWEGESER Separadores de Rama	154	Pinzas Laringo-Broncoscópicas	173-177
OBWEGESER Separadores mandibulares	156	Pinzas para amigdales	139-140
OBWEGESER Separadores para partes blandes	153	Pinzas para campo	272,273
OBWEGESER-FREER Elevadores	161	Pinzas para cateteres	138
OEHLER Pinzas de disección PROMEDUR	252	Pinzas para coger polypos	80
Olio para instrumentos	317	Pinzas para coger tejidos	243,264,267-269
OLSEN-HEGAR Porta-agujas	293	Pinzas para curaciones	275
OLSEN-HEGAR Porta-agujas PROMEDUR	289	Pinzas para desechos	300
OLSEN-HEGAR Porta-agujas PROMEDUR para ZURDOS	289	Pinzas para el tabique nasal	81,83,123
ORINGER Separadores para labios	131	Pinzas para el vómer	80
ORL Estuches Diagnósticos	9	Pinzas para esterilización	300
Osteótomos para huesos, OTOLOGIA	47,48	Pinzas para etmoides	83
Osteótomos, CIRUGIA ORAL	164,165	Pinzas para huesos etmoides	79
Osteótomos, RINOLOGIA	108-112	Pinzas para Laringo-Broncoscopia	203
OSTROEM Pinzas para seno-maxilar	84	Pinzas para ligaduras	253
OTOLOGIA	15-69	Pinzas para Microcirugia endolaringeal	198,199
<b>P</b>		Pinzas para microscopia	240
Paños de esterilización	313	Pinzas para pólipos	276
PAREL Intranasal Porta-agujas PROMEDUR	290	Pinzas para pólipos nasales	77
PARTSCH Cinceles para huesos	46	Pinzas para reposición, CHIRURGIA MAXILLO-FACIALE	169
PARTSCH Gubias para huesos	46	Pinzas para seno-maxilar	84
PARTSCH Martillos	49, 113	PINZAS PARA TEJIDOS Y ORGANOS	264,267-269
PASSOW Cinceles hemostáticas	45	Pinzas para tejidos y organos	264,267-269
PEAN-FINO Pinzas hemostáticas	263	Pinzas para tubos	274
PEARSON Pinza-gubias	66	Pinzas para vendajes	276
PECK-JOSEPH Tijeras nasales finas	88	Pinzas para vendajes con tapa	319
PEERS Pinza para campo para paños de papel	272	Pinzas per tamponamientos auricular	31
PELKMANN Pinzas para vendajes	276	Pinzas porta-esponjas	275-276
PENNIGNTON Pinzas para tejidos y organos	264	Pinzas quirúrgicas de disección	245-248
PENNINGTON Elevador per il setto	102	Pinzas quirúrgicas de disección USA Model	245
Perforadores, MICRO-OTOLOGIA	64	Pinzas saca-bocado para esfenoides	86-87
Periostótomos, CIRUGIA ORAL	162,163	Pinzas tira-lenguas	138
Periostótomos, OTOLOGIA	40,41	Pinzas, MICRO-OTOLOGIA	50
PERKINS Separadores autostáticos	58	PINZA-SELECT para microscopia	240
PERWITZSCHKY Tijeras para el canal salivar	126	Pinzas-gubias	66-67
PETRI cubeta	318	Pinzas-osteótomos, RINOLOGIA	87
PIERCE Elevador per il setto	102	Placas de identificación	311
PIERCE Trócares para el seno maxilar	93	PLESTER Cánulas aspiradoras	26
PIFFARD Curetas auriculares	35	PLESTER Cuchillo para lobulos, MICRO-OTOLOGIA	59
Piñon para fijar instrumental	315	PLESTER Ganchito para la platina estapedience	62
PINZA de disección USA-MODEL	244	PLESTER Guya para alambre, MICRO-OTOLOGIA	62
Pinza para abrir botellas de infusión	301	PLESTER Raspador, MICRO-OTOLOGIA	62
Pinza para ases	167	PLESTER Separadores autostáticos	56,58
Pinza para campo para paños de papel	272,273	Polipotomos nasales	76
Pinza para cartilagos	78	POLITZER (Buck) Cuchillo para furúnculos	34
Pinza para coger músculos	207	POLITZER Cuchillos auriculares	34
Pinza para coger tejido	207	POLITZER Espéculos auriculares	16
Pinza para columnella	78	POOLE Tubos de aspiración	298
Pinza para doblar alambra MICRO-OTOLOGIA	52	Porta-agujas	283-293
Pinza para el ático	87	Porta-agujas para Cirugia endolaringeal	199
Pinza para fijacion	78	Porta-agujas para ZURDOS	286
Pinza para fijación implantes nasales	107	Porta-algodones	25
Pinza para poner prótesis MICRO-OTOLOGIA	52	Porta-Instrumentos	301,314
Pinza paracortar alambre PROMEDUR	38	Porta-instrumentos para 8 Micro Instrumentos	315
		POST-MORTEM Hojas de bisturis	217
		POTTS-SMITH Pinza de disección	246,248
		POTTS-SMITH Pinzas de disección PROMEDUR	250

	Página		Página
POTTS-SMITH Pinzas quirúrgicos de disección	248	SELDIN Elevador	161
PRATT Cucharilla, RINOLOGIA	121	SEMKEN Pinzas de disección	243
Precintos de seguridad para esterilización	311	SEMKEN Pinzas de disección PROMEDUR	250
PRESBYTERIAN Pinzas para tubos	274	SENN-GREEN Separadores finas	281
PRINCE Tijera paraamigdales	141	SENN-MILLER Ganchos y Separadores	280
PRO-MED Pinza para fijación implantes nasales	107	SENN-MILLER-BABY Ganchos y Separadores	280
PRO-MED Porta-agujas PROMEDUR	290	Separador para el seno maxilar	94
PROVIDENCE-HOSPITAL Pinzas hemostáticas	259	Separador para el timo	210
Proyector halógeno de luz fría	14	Separador para mejillas movile	131,152
Pulverizadores	24	Separador para tiroides	210
Punzones para hemostatica	45	Separador para velor del paladar	142
		SEPARADORES	277-282
<b>Q</b>		Separadores autostáticos	55-58
QUIRE Elevador para cuerpos extra?os	31	Separadores cigomáticos	152
		Separadores con dientes	278
<b>R</b>		Separadores de Rama	154,155
RAGNELL (Kilner) Tijeras finas PROMEDR	231	Separadores extra orales	159
RAGNELL Separador	280	Separadores extra orales con luz fría	159,160
RAMA Separadores	154,155	Separadores intra orales	159,160
RANKIN-CRILE Pinzas hemostáticas	261	Separadores nasofaringeal	142
RANKIN-KELLY Pinzas hemostáticas	261	Separadores para labios	131
Recipiente para algodón	317	Separadores para mejillas	131,152
REICHERT Depresor para epiglotis	174	Separadores para mejillas	152
REINER-ALEXANDER Jeringas auriculares	24	Separadores para partes blandes	153
REYNOLDS Tijeras nasales finas	88	Separadores para RINOLOGIA	104
REYNOLDS Tijeras nasales finas SUPERCUT	88	Separadores para velor del paladar	142
RICHNAU-HOLMGREN Espéculos auriculares	17	SEXTON Cuchillos auriculares	34
RING Abaja-lenguas	136	SHAMBAUGH-DERLACKI Elavador para huesos	39
RINOLOGIA	71-126	SHAPLEIGH Curetas auriculares	35
Ri?oneras	319	SHEA Micro-Cucharillas, MICRO-OTOLOGIA	65
RITTER-HALLE Dilatadores para el seno frontal	94,296	SHEA Separador de aplicaciones varias con luz fría	160
ROCHESTER-PEAN Pinzas hemostáticas	263	SHEA-BELLUCCI Microtijeras auriculares	54
Rodillos para tubos	274	SHEEHAN Osteótomos, RINOPLASTIA	112
ROEDER Cierra-nudos tonsilar, para amigdalas	148	SIEBENMANN Tubos de aspiración	96
ROGER Elevadore per il perioosto	100	SIEGLE Espéculo auricular neumático	19
ROGGE Pinza para esterilización	300	Sierras nasales	120
ROSE Separador para traqueotomia	210	Silicone tiras de protección	314
ROSEN Cánulas aspiradoras	27	SILVER Osteótomos, RINOPLASTIA	109
ROSEN Cuchillo para incisiones, MICRO-OTOLOGIA	59	SLUDER-BALLENGER Amigdalótomo	149
ROSEN Cuchillos circulares, MICRO-OTOLOGIA	60	Sonda laríngeal para Microlaringologia	200
ROSEN Elevadores, MICRO-OTOLOGIA	65	Sondas aspiradoras del seno maxilar	95
ROSEN Micro-Agujas	62	Sondas auriculares	26
ROSEN Micro-Cucharillas, MICRO-OTOLOGIA	65	Sondas auriculares	26-30
ROSEN Movilizador, MICRO-OTOLOGIA	65	Sondas auriculares y para seno	296
ROSENBERG Pinza intercambiable	176	Sondas de medición	65
ROSER-KOENIG Abre-bocas	128	Sondas doble para el seno frontal	122
ROWE Pinzas para reposición	169	Sondas irrigadoras del seno maxilar	94,95
RUBIN Morselizer Septal	123	Sondas irrigadoras, RINOLOGIA	94-96
RUBIN Osteótomos, RINOPLASTIA	110	Sondas para bocio	208
RUMEL Pinzas hemostáticas	265	Soporte para abre-bocas	137
RUSSEL-DAVIS Abaja-lenguas	136	SPRAGUE Juego otologico	34
RYDEL-SEIFFER Diapason	22	ST.CLAIR-THOMSON Cuchillos p.vegetaciones adenoideas	125
<b>S</b>		STACKE Sonda auriculare	25, 296
Saca-hilos para Microlaringologia	200	STAMMBERGER Pinzas cortantes circular	85
SAUERBRUCH estuche para agujas	318	STEINHÄUSER Cinceles para ramo	164
SAUERBRUCH Pinza para desechos	300	STEINHÄUSER Osteótomos para ramo	164
SAWTELL (George) Pinza para amigdales	139	STEINHÄUSER Separadores cigomáticos	152
SAWTELL Pinzas para amigdales	139	STELLBRINK Pinzas-gubias	67
SCHAEDEL Pinza para campo	272	STERNBERG Separadores para mejillas	131
SCH EINMANN Pinzas intercambiables	175	STEVENS Tijeras para tenotomia	226
SCHIMMELBUSCH Cajas para esterilización	316	STILLE Pinzas de disección	244
SCHMEDEN Pinza nasale cortante	81	STRABISMUS Tijeras finas PROMEDR	231
SCHNIDT Pinzas para amigdales	139	STRANDELL-STILLE Ganchos y Separadores	279
SCHOEMAKER Tijeras para bocio	208	STRINGER estribos para instrumentos	301
SCHOENBORN Separador para tiroides	210	STRUMEPEL Pinzas auriculares	32
SCHUKNECHT Cuchillos, MICRO-OTOLOGIA	59	STRUYCKEN Pinzas nasales cortantes	81
SCHUKNECHT Pinza para doblar alambra	52	Sujetafiltros	312
SCHUKNECHT Separador autostático	58	SUTURA	283-293
SCHUMACHER Pinzas intercambiables	176	<b>T</b>	
SEBILEAU Elevador para huesos	39	TABB Cuchillo, MICRO-OTOLOGIA	59
SEIFFERT Estilette para el canal salivar	94	TAKAHASHI Pinzas para el tabique nasal	83
SEIFFERT Pinza intercambiable	175	TAKAHASHI Pinzas para etmoides	83
		Tapice portas instrumentos de silicona	313



	Página		Página
Tarros inox.	320	<b>W</b>	
TAYLOR Pinza de disección	247	WAGENER Ganchitos auriculares	36
TAYLOR Pinzas quirúrgicos de disección	248	WALKER Tijeras finas	225
TAYLOR-CUSHING Pinzas de disección	247	WALSHAM Pinzas para el tabique nasal	123
TAYLOR-CUSHING Pinzas quirúrgicos de disección	248	WALTER Cinceles, RINOPLASTIA	110
Tensores cierra-hilos autoáticos	167	WALTER Osteótomos, RINOPLASTIA	110
TESSIER Mobilizadores	168	WALTER Separador para alas de nariz	106
TESSIER Osteótomos, CIRUGIA ORAL Y MAXILOF.	165	WALTON Pinzas porta-esponjas	275
TESSIER Periostótomos	162	WANGENSTEEN Pinza de disección PROMEDUR	250
THIES Martillo	49, 113	WATSON-CHEYNE Elevador	101
THUDICHUM Espéculos nasales	75	WATSON-CHEYNE Sondas nasales	102
TIECK-HALLE Espéculos nasales	73	WATSON-WILLIAMS Pinza para coger	79
TIJERAS	221-236	WATSON-WILLIAMS Pinzas nasales cortantes	81
Tijeras finas	224-226	WATSON-WILLIAMS Pinzas para hueso etmoides	79
Tijeras finas para preparaciones	225,226,228,230	WAUGH Pinzas de disección	247
Tijeras finas para preparaciones SUPPERCUT	228-230	WEBSTER Porta-agujas	291
Tijeras finas PROMEDUR	231,232,234-236	WEBSTER Porta-agujas.PROMEDUR	285
Tijeras nasales	88-92	WEIL-BLAKESLEY Pinzas nasales cortantes	82,83
Tijeras nasales con vástago tubular	91	WHITE Pinzas para amigdales	139
Tijeras para amigdales	141	WHITEHEAD Abre-bocas	132
Tijeras para anatomía	226	WIBERG Legras	103
Tijeras para bocio	208	WIEDER Abaja-lenguas	130
Tijeras para cirugía general	227	WIENER Escofinas nasales	118
Tijeras para el canal salivar	126	WILDE Cierranudos, RINOLOGIA	76
Tijeras para Face-Lift	141	WILDE Pinza auricular angolate	33
Tijeras para hilos	37,38	WILDE Polipotomos auriculares	37
Tijeras para Microcirugía	222-223	WILLIGER Curetas auriculares	43,44
Tijeras para Microcirugía endolaringeal	198	WILLIGER Elevadores para huesos	39
Tijeras para tenotomía	226	WILLIGER Ganchos auriculares	36
Tijeras, PROMEDUR	231-236	WILLIGER legras	40
TILLEY Pinza per tamponiamentos auricular	31	WILLIGER Martillo	49, 113
TILLEY-HENCKEL Pinza para etmoides	84	WISCONSIN-FOREGGER Laryngoscopios	185
Tiras de protección	314	WULLSTEIN Pinzas auriculares MICRO-OTOLOGIA	51
TIVNEN-TYDING Pinzas para amigdales	140	WULLSTEIN Cánulas aspiradoras	26
TOBOLD Abaja-lengua	129	WULLSTEIN Cuchillo, MICRO-OTOLOGIA	59
TOENNIS-ADSON Tijeras finas PROMEDUR	232	WULLSTEIN Mango para aspiración	26
TOHOKU Pinza para campo para paños de papel	273	WULLSTEIN Micro Canula de aspiración	29
TOYNBEE Espéculos auriculares	16	WULLSTEIN Microtijeras auriculares	53
TRAQUEOTOMIA	206-210	WULLSTEIN Pinzas auriculares	50
TRAQUEOTOMIA, BOCIO	205-210	WULLSTEIN Separadores autostáticos	57
Traqueotomos	207		
Trepanos, MICRO-OTOLOGIA	64	<b>Y</b>	
Trócares para el seno maxilar	93	YANKAUER Agujas para suturas	107
TROELTSCH Pinzas auriculares angolate	33	YANKAUER Tubos de aspiración	297
TROELTSCH Pinzas de disección, RINOLOGIA	78	YASARGIL Tijeras para Microcirugía	223
TROELTSCH Sondas auriculares	26	YOUNG Pinza tira-lenguas	138
TROUSSEAU Dilatador para la traquea	207		
Trnsformador para CLAR	13	<b>Z</b>	
Tubos alargaderos	175	ZAUFAL Elevador auricular	35
Tubos aspiración nasal	95	ZAUFAL Elevador para cuerpos extra?os	36
Tubos aspiradores	95,96,297-298	ZAUFAL-JANSEN Ganchito auricular	36
Tubos de succión	27	ZAUFAL-JANSEN Pinza-gubias	67
TUFFIER Pinzas para tejidos y organos	264	ZIEGLER Alicates para cortar alambre PROMEDUR	167
TYDING Cierra-nudos tonsilar, para amigdalas	148	ZIEGLER Espejo frontal	13
TYDING Cuchillo para amigdalas	147	ZOELLNER Espéculos auriculares	17
		ZOELLNER Micro-cánulas aspiradoras	27
<b>U</b>		Zurdos, Pinzas hemostáticas	258
UCKERMANN Porte-algodon	25	Zurdos, Porta-agujas	286
UCKERMANN Traqueotomos	207	Zurdos, Tijeras	224,228,229
UNIVERSAL Alicates para alambres	38		
UNIVERSAL Tijeras para hilos	37		
UNIVERSITY of MINNESOTA Abaja lenguas	129		
USA-MODELO Pinzas para tubos	274		
<b>V</b>			
VANNAS Tijeras para Microcirugía	223		
Vasos graduados	320		
VIENNA Espéculo Nasale Mod.ligero	72		
VIENNA Espéculos nasales	72		
VISE Micro-Pinzas para ligaduras	253		
VOLKMANN Curetas auriculares	44		
VOLTOLINI Espéculos nasales	75		

# INDICE ALFABÉTICO

## A

Abassalingua per narcosi	132-136
Abassalingua, anestesi	133
ABRAHAM Bisturi per tonsille	147
Accessori per sterilizzazione	303,305,307,309,310,311-315
Adenotomi	126
ADSON Pinze anatomiche	241
ADSON Pinze anatomiche PROMEDUR	250
ADSON Pinze chirurgiche PROMEDUR	250
ADSON Pinze emostatiche	262
ADSON-BABY Pinze emostatiche	262
ADSON-BROWN Pinze chirurgiche PROMEDUR	252
ADSON-DEBAKEY Pinze atraumatiche	241
ADSON-DEBAKEY Pinze per dissezione con denti	243
ADSON-GRAEFE Pinze de dissezione	243
ADSON-MICRO Pinze anatomiche	241
ADSON-MICRO Pinze chirurgiche	242
ADSON-SELECT MICRO Pinze chirurgiche	242
ADSON-SELECT Pinze chirurgiche	242
Aghi per legatura	107
Aghi per legatura e tonsille	145,146
Aghi per paracentesi	34
ALLIS Pinza per afferare tessuti	264
ALLIS Pinze atraumatiche per afferare tessuti	267
ALLIS Pinze per afferare tessuti	264
ALLIS-ADAIR Pinza per afferare tessuti	267
ALLIS-BABY Pinze per afferare tessuti	264
ALLPORT Divorcatore autostatico	56
ALLPORT Uncino auricolare	36
ALM Divoricatori autostatici	55
ALM-MODIF. Divoricatori autostatici	56
ANDREW Spatola per lingua	129
ANDREW-PYNCHON Tubo d'aspirazione	297
ANTRUM Coltelli	97
Apri flebo	301
Apribocca	128,132,132-136
Apribocca per narcosi	132-136
Apribocca, anestesi	132-136
ASCH Pinza per il setto nasale	123
Aspirazione	297-298
Assordatore	22
Astucci per diagnostica	8-12
AUFRICHT Divaricatori nasali	105
AUFRICHT Forbici nasale	91
AUFRICHT Raspe nasali	118
AUSTIN Contelli, MICRO OTOLOGIA	59
AUSTIN Osteotomi, MICRO OTOLOGIA	64
AUSTIN Pinze per legature	253
AUTOFILL Siringa per irrigazione	23

## B

BABCOCK Pinze per afferare organi e tessuti	268
BABCOCK-DEBAKEY Pinze per afferare tessuti	268
BABY-ADSON Pinze emostatiche	262
BABY-ALLIS Pinze per afferare tessuti	264
BABY-CRILE Pinze emostatiche	259
BABY-CRILE-WOOD Portaghi PROMEDUR	286
BABY-METZENBAUM Forbici per dissezione	228
BABY-MIXTER Pinze emostatiche	266
BABY-SENN-MILLER Divaricatori delicati	280
Bacinella per compresse	320
BACKHAUS Pinze fissateli	272
BACKHAUS Pinze fissateli con porta tubi	272
BALL e SOCKET Pinze fissateli	273
BALLENGER Bistruri per cartilagine	97
BALLENGER Coltello per setto con lama girevole	99
BALLENGER Elevatore	101
BALLENGER Pinza per tonsille	140
BARANY Assordatore	22
BARBARA Aghi, MICRO OTOLOGIA	62
BARBARA Uncini, MICRO OTOLOGIA	61
BARNHILL Coltelli anulari per vegatazioni adenoide	125

Pagina

BARRON Canule per irrigazione e aspirazione	94
BARRON Manico per bisturi	216
BARSKY Divarcatore cuteano	105
BAUER Separatori intraorali	157
BAUER Separatori intraorali con luce fredda	157
BAUMGARTNER Portaghi	291
BAUMGARTNER Portaghi PROMEDUR	285
BECKMANN Coltelli anulari per vegatazioni adenoide	124
BECKMANN Specoli nasali	73
BEEBEE Forbici para fili metallici	38
BELLUCCI Forbici auricolari	53
BERNHARD Pinza fissateli	273
BEYER Pinza per l'atico	87
BEYER Pinze-sgorbie	66,67
Bicchieri per medicinale	320
BILLEAU lacci auricolari	35
BIRKETT Pinze emostatiche	140
BISHOP Separatore per labbra	131
Bisturi per il timpano	34
Bisturi per Microlaringologia	200
Bisturi per rinoplastica	97-99
Bisturi per tonsille	147
BLANK Pinze atraumatiche	244
BLOHMKE Pinza per tonsille	140
Boca y lengua, Amigdalectomia	127-149
BOEHLER Cesioie per osse	69
BOEHLER Pinze-sgorbie	67
BOETTCHER Forbici per tonsile	141
BOIES Elevatore per fratture nasali	107
BONNEY Pinza anatomiche PROMEDUR	251
BONNEY Pinza chirurgiche PROMEDUR	252
BOSE Divarcatore traqueale	55,207
BOSE Uncini tracheali	209
BOSWORTH Spatola per lingua	130
BOUCHERON Specoli auricolari	16
BOWMAN Sonde esploratrici	296
BOYS-ALLIS Pinza per afferare tessuti	267
BROMPTON Pinza per drenaggio	274
BROPHY Pinze anatomiche	244
BROPHY Pinze chirurgiche	247
BRUENINGS Bisturi per tonsille	147
BRUENINGS Coltello per il setto nasale	99
BRUENINGS Pinze intercambiabile	175
BRUENINGS Pinze per il setto nasale	79
BRUENINGS Serranodo per tonsille	148
BRUENINGS Spatola per lingua	129
BRUENINGS Speculo auricolare pneumatico	19
BRUENINGS Tubi di prolungamento	175
BRUENINGS-BRUNK Divarcatore per seno mascellarare	94
BRYANT Pinza per medicatura	275
BÜCHS Divarcatore per guancia	152
BUCHWALD Spatola per lingua	129
BUCK Curetta auricolari	42
BUCK Pinza per corpi estranei	31
BUCKINGHAM Perforatori, MICRO OTOLOGIA	64
BUCKINGHAM Scalpello, MICRO OTOLOGIA	64
BUCKLEY Scalpelli	45
BUCKLEY Sgorbie	45
Bulldog, Pinze	256
BUNT Clip per sterilizzazione	301

Pagina

## B

CANFIELD Bisturi per tonsille	147
Cannula per aspirazione	95,96,297-298
Cannule aspiratrice, OTOLOGIA	26-30
Cannule irrigatrici per seno masellare	94
Cannule per iniezione per laringoscopi	193
Cannule per irrigazione e aspirazione	94
Cannule tracheali	206
CAPLAN Forbici per il setto nasale	92
CARPENTER Dissettori per tonsille	144
CARREL Pinza emostatiche	257
Casetta de selezione tharghette	311
Cassette per Micro-strumenti	316

	Pagina		Pagina
CASTELNUOVO Sonde per sino frontal	122	Cucchiaio per medicina	320
CASTROVIEJO Portaghi	284	Cuchiai taglienti, OTOLOGIA	42
CASTROVIEJO Portaghi PROMEDUR	284	Cuchiette auricolari, MICRO OTOLOGIA	65
Cesoie per osse	68-69	Curetta auricolari	42-44
Cestelli per sterilizzazione ALUMINIO	303,305,307,309,310	Curette auricolari	35
Cestelli piatti ALUMINIO	308	Curette per lupus	35
Cestelli rotondi per sterilizzazione	316	Curette per sino e anatro	121,122
CHAPUT Pinza per afferare tessuti	264	CUSHING Divaricatori	281
CHEATLE Pinza per la sterilizzazione	300	CUSHING Pinze anatomiche	246
CHEVALIER-JACKSON Pinze per Bronco-Esofagoscopia	177	CUSHING Pinze chirurgiche PROMEDUR	250
CICHERELLI Pinza-sgorbia	66	CUSHING-LANDOLT Specoli nasali	75
CINELLI Forbici nasale	90		
CINELLI Osteotomi, RINOPLASTICA	111	<b>D</b>	
Cirurgia Craneo-Maxillofaciale	151-169	DANDY Pinze emostatiche	260
CITELLI Pinze ossivori	87	DANDY-MOSQUITO Pinza emostatiche	260
CLAR lampada frontale LUCE FREDO	14	DANIELS Tonsillotomi	149
CLAR Specchi frontali	13	DAUGHTY (WÜRZBURG) Abassalingua	135
CLAUS-EICKEN Ago per legatura	145	DAVIS Pinze per la sterilizzazione	300
CLEVELAND Cesoie per osse	68	DAVIS-BOYLE Apribocca per narcosi	132
COAKLEY Curette per anatro	121	DAVIS-MEYER Apribocca per narcosi	133
COAKLEY Trequarto per tracheotomia	93	DAY Uncini auricliari	36
COLLER-CRILE Pinze emostatiche	261	DEAN Bisturi per tonsille	147
COLLIER Portaghi	291	DEAN Forbici nasali PROMEDUR	92,141
COLLIN Manici per bisturi	215,218	DEAN Forbici per tonsile	141
COLLIN Pinza tiralingua	138	DEBAKEY Pinze atraumatiche	248,249,251
COLLIN Pinze per afferare organi e tessuti	269	DEBAKEY Pinze atraumatiche TITANIO	248
Coltelli anulari per vegetazioni adenoide	124,125	DEBAKEY Pinze chirurgiche PROMEDUR	251
Coltelli per antrum	97	DEBAKEY-ADSON Pinze atraumatiche	241
Coltelli, MICRO OTOLOGIA	59,60,65	DEBAKEY-ADSON Pinze per disezione con denti	243
COLVER Pinze per tonsille	140	DEBAKEY-BABCOCK Pinze per afferare tessuti	268
Concotomi circolari per biopsia con irrigazione, RINOLOGIA	85	DEBAKEY-GERALD Pinze atraumatiche	246
Concotomi, RINOLOGIA	81	DEBAKEY-SELECT Portaghi DIAMANTE	287
CONVERSE Bisturi per rinoplastica	98	DENHARDT Apribocca	128
CONVERSE Divaricatore nasale	106	Depressore epiglottico	174
CONVERSE-ALAR Divaricatori	106	DERF Portaghi	291
COPE Divaricatore	281	DERF Portaghi PROMEDUR	285
Coperchi "Endoscopia"	310	Diagnostico	7-15
Coperchi per sterilizzazione	302,304,306,308,310,316	Diapasoni	20-22
CORDES Pinze intercambiabile	176	DIETER Pinze per testa del martelletto	52
COTTLE Divaricatore nasale	105	DIETRICH Pinze Bulldog	256
COTTLE (Millard) Uncino nasale	106	Dilatatori per seno frontale	94,296
COTTLE Coltelli per il setto nasale	98	Dilatatori tracheali	207
COTTLE Divaricatore bottonuta	105	DINGMAN Apribocca	134
COTTLE Divaricatore nasali	104	DINGMAN Elevatori per zigoma	161
COTTLE Elevatori nasali	101	DINGMAN Guancii per zigoma	160
COTTLE Martello	49, 114	Dissetto con aspirazione	103
COTTLE Osteotomi	108	Dissettori per tonsille	143,144
COTTLE Osteotomi, RINOPLASTICA	110	Dissettori, MICRO OTOLOGIA	63
COTTLE Periostotomo nasale	101	Distributori del cotone	317
COTTLE Pinza per comunella	78	Distributori di filtri	312
COTTLE Pinza per tessuto e cartilagine	78	Divaricatori	277-281
COTTLE Raspa nasale	118	Divaricatori a mano	278-281
COTTLE Specoli nasali	74	Divaricatori delicati	278-281
COTTLE Specoli nasali nero	74	Divaricatori di guance	131,152
COTTLE Strumento per cartilagine	107	Divaricatori per l'ugola	142
COTTLE torchio per cartilagine	107	Divaricatori per Ramo	154,155
COTTLE Uncini nasali	104,105	Divaricatori per seno mascellarare	94
COTTLE-BULLDOG Forbici nasali	90	Divaricatori per spina nasali	154
COTTLE-DORSAL Forbici nasali	90	Divaricatori per tessuti molli	153
COTTLE-DORSAL Forbici nasali SUPERCUT	90	Divaricatori per zigoma	152
COTTLE-KAZANJIAN Cesoia per ossa	68	Divaricatori autostatici	55-58
COTTLE-MASING Forbici nasali	91	DOCKHORN Divaricatori per guancia	152
COUPLAND Cannula per aspirazione	95,297	DOUGLAS Trequarto per seno mascellare	93
CRAIG Pinze per vomere e setto nasale	80	DOYEN Portaghi	291
CRILE Divaricatore	280	DOYEN Spatole per lingua	129
CRILE Pinze emostatiche	259	DOYEN-JANSEN Apribocca	128
CRILE Portaghi	292	DRAFFIN Bipod per apribocca	137
CRILE-BABY Pinze emostatiche	259	DUNHILL Pinze emostatiche	259
CRILE-COLLER Pinze emostatiche	261	DUPUY-WEISS Ago per tonsille	145
CRILE-MURRAY Portaghi	292	DUVAL Pinze per afferare organi e tessuti	269
CRILE-RANKIN Pinze emostatiche	261		
CRILE-WOOD Portaghi	292	<b>E</b>	
CRILE-WOOD Portaghi PROMEDUR	286	EICKEN-KILLIAN Cannule irrigatrici per seno masellare	94,95
CRILE-WOOD-BABY Portaghi PROMEDUR	286	Elevatori per fratture nasali	107
Cucchiai doppii, OTOLOGIA	42		

	Pagina
Elevatori per Microlaringologia	200
Elevatori per RINOPLASTICA	99-102
Elevatori per zigoma	161
Elevatori, MICRO OTOLOGIA	65
Elevatori, OTOLOGIA	39,40
EVES Serranode p. tonsille	148
EWALD Pinze anatomiche	241
EWALD Pinze con denti	242
EXTRA ORAL Separatori	159
<b>F</b>	
FALK Aghi per legatura e tonsille	146
FARABEUF Periostotomi	41
FARRELL Portacotone	25
FARRIOR Specoli auricolari	17
FARRIOR Specoli auricolari NERO	17
FAULKNER Curetta per antro	121
FAULKNER Sgorbia per cavita mascellare	110
Fermafiltri	312
Fili per osse SMO	166
Fili per serramodi	148
Fili per serranodi auricolari	37
Filo per serranodi nasali	76
Filo-puliere per FRAZIER/FERGUSON	30
Filo-puliere per MAGILL Cannule	96
Filtri, carta	312
Filtri, tessile	313
FINSEN Divoricatori autostatici	55
FISCH Micro Dissettori, MICRO OTOLOGIA	63
FISCH Perforatori, MICRO OTOLOGIA	64
FISCH Tubi per aspirazione e lavaggio	28
FISH Sonde esploratrici	25, 296
FOCUS Lampada frontale LUCE FREDDO	14
FOERSTER Pinze per tamponi e sponge	275
FOMON Bisturi per rinoplastica	97
FOMON Forbici nasale	90
FOMON Osteotomi, RINOPLASTICA	109
FOMON Raspe nasali	116
FOMON Raspe nasali PROMEDUR	117
FOMON Uncini nasali	105
FOMON-DORSAL Forbici nasali	89
Forbici	221-236
Forbici delicate	224-228,231-232
Forbici nasali	88-92
Forbici per chirurgia	226,227
Forbici per condotto saliva	126
Forbici per dissezione	226,228-236
Forbici per Face-Lift	141
Forbici per fili metallici	37,38
Forbici per gozzo	208
Forbici per MANO SINISTRA	224,228,229
Forbici per Micro-Endolaringea	198
Forbici per strabismo	225,231
Forbici PROMEDUR	231-236
Forbici SUPERCUT	224-226,228-229
Forchetta per Microlaringologia	200
FOSTER-GILLIES Portaghi PROMEDUR	288
FOWLER Bisturi per tonsille	147
FRAENKEL Pinza per polipi laringei	173,174
FRAENKEL Pinze intercambiabile	175
FRAZIER Tubi per aspirazione e lavaggio	29,30
FRAZIER Tubi per aspirazione isolare	29
FRAZIER Tubi per aspirazione, illuminazione allogena	29
FREER Coltelli per il setto nasale	99
FREER Coltello per mucosa	98
FREER Elevatori per il setto nasale	100
FREER Scalpelli, RINOLOGIA	108
FREER Sgorbie per setto nasale	108
FREER Uncino per mucosa	104
FREER-INGALS Coltello persubmucosa	98
FRIEDMANN Pinze-sgorbie	66
FRIEDMANN-MINI Pinze-sgorbie	66
FSHER Bisturi per tonsille	147
FULLER Pinza porta-introduci protesi	52

## G

GEMINI Pinze emostatiche	265
GEMINI-MINI Pinze emostatiche	265
GERALD Pinze anatomiche	246
GERALD Pinze chirurgiche	247
GERALD Pinze chirurgiche PROMEDUR	251
GERALD-DEBAKEY Pinze atraumatiche	246
GEUDEL-NEGUS laringoscopi a luce fredda	186
GILLIES Pinza chirurgiche PROMEDUR	251
GILLIES Elevatore	161
GILLIES Pinze de dissezione	243
GILLIES Portaghi	293
GILLIES Portaghi PROMEDUR	289
GILLIES-MINI Portaghi	293
GILLIES-MINI Portaghi PROMEDUR	289
GLASSMANN Pinze atraumatiche	249
GOLDMAN-FOX Forbici delicate PROMEDUR	231
GOLDMANN Elevatore per fratture nasali	107
GOOD Forbici per tonsile	141
GORNEY (Killian) Forbici per il setto nasale	92
GORNEY Dissetore a aspirazione	103
GORNEY Forbici per Face-Lift	141
GRAEFE Pinze delicate	238,239
GRAEFE Pinze delicate con denti	239
GRAEFE Pinze delicate TITANIO	238
GRAEFE-SELECT Pinze delicate	238,239
GRAZIL Forbici per chirurgia	227
GREVEN Pinza auricolare delicate	51
GROSS Cucchiai, Curette, Uncinetti auricolari	35
GROSS Pinze per medicature	276
GRUBER Specoli auricolari	16
GRUENWALD (Jansen) Pinze per medicature	78
GRUENWALD Pinze nasali	78
Guancio per mento	156
Guancio per zigoma	160
GUASTELLA-EY Osteotomi, RINOPLASTICA	109
GUILDORD Forbici para fili metallici nero	38
GUILLEN Raspatorio con aspiratore	95
GUNNAR-HEY Pinza per drenaggio	274

## H

HAJEK Martello	49, 113
HAJEK-BALLENGER Elevatori nasali	101
HAJEK-KOFLER Pinze sfenoidali	86
HALLE Elevatore nasale	100
HALSEY Portaghi	291
HALSEY Portaghi PROMEDUR	285
HALSEY-MICRO Portaghi PROMEDUR	285
HALSTED Pinze emostatiche	262
HALSTED-MOSQUITO Pinze emostatiche	258
HARRISON Pinze per la sterilizzazione	300
HARTMANN Cannule per lavaggio	27
HARTMANN Diapasoni	21
HARTMANN Pinza per ligature	257
HARTMANN Pinza per polipi auricolari	31
HARTMANN Pinze auricolari delicate	32
HARTMANN Pinze per tamponamento, RINOLOGIA	77
HARTMANN Pinze tagliante e tonsillari	84
HARTMANN Sonde auricolari	26
HARTMANN Spatola per lingua	130
HARTMANN Specoli auricolari	16
HARTMANN Specoli nasali	72
HARTMANN-HALLE Specoli nasali	72
HARTMANN-MICRO Pinze auricolari delicate	50
HARTMANN-MICRO Pinze emostatiche	257
HARTMANN-WULLSTEIN Pinze auricolari delicate	51
HARVEY Forbici per fili metallici	37
HASLINGER Retratore per velo pendulo	142
HEERMANN Manico per strumenti	201
HEISTER Atribocca	128
HENKE Dissettori per tonsille	143
HEUWIESER Pinze da presa per polipi seno mascellare	80
HEYMANN Forbici nasale	89
HEYMANN Pinze nasali tagliante	79



	Pagina		Pagina
Hipofaingscopio	192	KIRSTEIN Forbici nasale	89
HOFER Divaricatore per velo pendulo	142	KLAPP Divaricatori delicati	279
HOFFMANN Pinza auricolare	32	KLING-EX Levare-lame	219
HOKE Osteotomi, OTOLOGIA	47	KNIGHT Pinza per polipi nasali	77
HOLINGER Laringoscopio	194	KOCHER Pinze emostatiche	263
HOLTZHEIMER Divoricatori autostatici	56	KOCHER Sonde per gozzo	208
HOUSE Adattatore Luer/Luer con interruttore	28	KOCHER-FINO Pinze emostatiche	263
HOUSE Cucchiali, OTOLOGIA	42	KOENIG Diapason regolabili a109 - g	22
HOUSE Divaricatore delicate	280	KOENIG Elevatori, OTOLOGIA	39
HOUSE Sonde di misurazione	65	KOENIG Periototomo, OTOLOGIA	40
HOUSE Sonde, MICRO OTOLOGIA	65	KÖNIG Divaricatori delicati	279
HOUSE Tubi per aspirazione e lavaggio	28	KONRICH Cestelli rotondi per sterilizzazione	316
HOWARTH (Burton) Elevatore	102	KRAUSE Pinze intercambiabile	176
HUBER Manico universale	175	KRAUSE Serranode auricolare	37
HURD Aghi per legatura e tonsille	146	KRAUSE Serranode per polipi nasali	76
HURD Dissettori per tonsille	143	KRAUSE Trequarto	94
HYLIN Periototomi, OTOLOGIA	41	KRAUSE-VOSS Serranode per polipi nasali	76
		KROENIG Spatola per lingua	129
		KUHN-BOLGER Curette per sino	121
<b>I</b>		<b>L</b>	
Intranasal Portaghi PROMEDUR	290	LABORDE Dilatatore traqueale	207
Iris Forbici delicate PROMEDUR	231	Lacci auricolari	35
ITERSON Uncini tracheali	209	Lacci in acciaio per serranodi	148
		Lacci Preformati per serranodi auricolari	37
<b>J</b>		LACK Spatole per lingua	130
JACKSON Cannule tracheali	206	LA-FORCE Adenotomi	126
JACKSON Laringoscopi per operazione	194	LAHEY Pinze per presa gozzo	207
JACKSON Pinze laringei	173	LAHEY-METZENBAUM Forbici per dissezione	228
JACKSON Tubi per aspirazione	177	Lame per bisturi	213,217
JACKSON Uncini tracheali	209	Lame per Bisturi e Manici	212-219
JACOBSON-MICRO Pinze	258	LANDAU Trequarto nasale	93
JAKO Strumentario per endoscopia orale	201,202	LANDOLD Manici per bisturi	212
JAMESON Forbici nasali	88	LANE Pinze fissateli	273
JAMESON Forbici nasali SUPERCUT	88	LANGE Pinza per polipi laringei tondo	174
JAMESON-WERBER Forbici nasale	88	LANGE Pinza intercambiabile	175
JANSEN Cucchiali, OTOLOGIA	43	LANGENBECK laccio auricular	35
JANSEN Divoricatori autostatici	56	LANGENBECK Portaghi PROMEDUR	287
JANSEN-MIDDLETON Pinze per il setto nasale	81	LANGENBECK-MINI Divaricatori	281
JEFFERSON Pinze de dissezione	243	Laringo-Bronco-Esofagoscopia	171-195
JENNINGS Apribocca	132	Laringo-Broncoscopia	175-176
JOBSON-HORNE Portacotone	25	Laringo-Broncoscopia, Pinze	178
JONES Pinze fissateli	272	Laringologia	197-203
JOSEPH (Masing) Coltello per rinoplastica	98	Laringoscopi	179-194
JOSEPH Bisturi per rinoplastica	97,98	Laringoscopi per operazione	191-194
JOSEPH Elevatori per il setto nasale	101,102	Laringoscopi per operazione	191-194
JOSEPH Protettore guidasega	120	LAZAR Micro-Pinza per legature	253
JOSEPH Raspe nasali	115	LE MEE Spatola per lingua	130
JOSEPH Seghe nasali	120	LEMPERT Cuchiai taglienti, OTOLOGIA	44
JOSEPH Strumento di misura, RINOLOGIA	120	LEMPERT Elevatore, OTOLOGIA	39
JOSEPH Uncini nasali	104	LEMPERT Periototomi, OTOLOGIA	40
JOSEPH-MASING Elevatore	102	LEMPERT Pinze-sgorbie	67
JUDD-ALLIS Pinze per afferare tessuti	267	LERICHE Pinze emostatiche	260
JULIAN Portaghi PROMEDUR	287	LERMOYEZ Trequarti per seno mascellare	93
JURASZ Pinze per polipi laringei	173	Levare-lame	219
		LeVASSEUR-MERRILL Divaricatori extraorali	160
<b>K</b>		LEWIS Raspe nasali	118
KABIERSKE Polverizzatori	24	LEXER-BABY Forbici delicate PROMEDUR	231
KANTROWITZ Pinze emostatiche	265	LEXER-MINI Osteotomi, OTOLOGIA	48
KAYE Portaghi PROMEDUR	289,290	LEXER-MINI Sgorbie, OTOLOGIA	48
KAYE-MILLARD "Facelift" Divaricatore	106	LEYLA Portaspeculi auricolari e accessori	18
KELLY Forbici per chirurgia	226	LICHTWITZ Trequarto per tracheotomia	93
KELLY Pinze emostatiche	259	LICHTWITZ-BIER Aghi per trequarti	93
KELLY-RANKIN Pinze emostatiche	261	Ligature, Micro-Pinze per	253,257
KELSEY-FRY Punteruoli	166	LISTER-SINUS Pinze per medicatura	275
KERRISON Pinze ossivore, RINOLOGIA	86	LITTAUER Pinza per polipi nasali	77
KILLIAN Cannula irrigatrice	96	LITTAUER Pinza per tamponamento dell' orecchio	31
KILLIAN Elevatori nasali	102	LITTAUER-LISTON Cesoa per ossa	68
KILLIAN Specoli nasali	73	LITTLEWOOD Pinza per afferare tessuti	267
KILLIAN-Claus Sgorbia per setto nasale	108	LOCKLIN Forbici nasali	89
KILNER Divaricatori nasali	106	LOCKLIN Forbici nasali PROMEDUR	92
KILNER Forbici per operazione e preparazione	91	LOPEZ-REINKE Dissetto per tonsille	144
KILNER Portaghi	285	LORNA Pinze fissateli	273
KILNER Portaghi PROMEDUR	291	LOVE Divaricatori per l'ugola	142
KILNER-DAUGHTY Apribocca	135		

	Pagina		Pagina
LOVELACE Pinze emostatiche	260	Micro-Endolaringea	198-202
LUBET-BARBON Pinza per polipi nasali	77	Micro-Forbici auricolari	53-54
LUC Pinze taglienti	80	MICRO-HALSEY Portaghi PROMEDUR	285
LUCAE Aghi per paracentesi	34	MICRO-HARTMANN Pinze emostatiche	257
LUCAE Diapason regolabili a h	22	MICRO-JACOBSON Pinze emostatiche	258
LUCAE Martelli	49, 114	MICRO-MOSQUITO Pinze emostatiche	258
LUCAE Pinze a fomre di baionetta	33	MICRO-Pinze con denti	239
LUCAE Uncini auricolari	36	Micro-Portaghi	284
LUCAS Osteotomi	46, 110	MILLER laringoscopi a luce fredda	189,190
LUCAS Sgorbie	46, 110	MILLER Raspe nasali	119
LUCE FREDO lampada frontale CLAR	14	MILLER Raspe nasali PROMEDUR	119
LUER Cannule tracheali	206	MILLER-BABY laringoscopia	182,184
LUER Cannule tracheali per parlare	206	MILLER-BABY Spatole a luce fredda	190
LUER Divaricatore	280	MILLESI Micro Forbici	223
LUER Pinze-sgorbie	66	Mini-Coperchi ALUMINIO	308
LUKENS Uncino per il timo	210	MINI-GEMINI Pinze emostatiche	265
LUNIATSCHEK Tamponatore	144	MINI-LANGENBECK Divaricatori	281
		Misurine graduati	318
<b>M</b>		MIXTER Forbici delicate	226
MAGILL Cannule per aspirazione, RINOLOGIA	96	MIXTER-BABY Pinze emostatiche	266
MAGILL Pinze per intubazione	138	MOBERG Divaricatori	279
MALTZ Coltello per rinoplastica	98	MOBERG Osteotomi, RINOPLASTICA	111
MALTZ Divaricatore nasale bottonuta	105	Mobilizzatore	168
MALTZ Raspe nasali	115	MOLDENHAUER Leva auricolari	35
MALTZ-TC Raspe nasali PROMEDUR	115	MOLLISON Divaricatori autostatici	57
Manici per bisturi	214-216,218-219	MOSQUITO Pinze emostatiche	258
Manici per Micro-bisturi	212	MOSQUITO-MICRO Pinze emostatiche	258
Manici per specchietti laringei	172	MYLES Pinze nasali tagliente	81
MANICO per fissare strumenti	201		
MANO SINISTRA, Forbici	224,228,229	<b>N</b>	
MANO SINISTRA, Pinze emostatiche	258	NAGER Ago per legatura	145
MANO SINISTRA, Portaghi	285,286	NAGER Divaricatore per velo pendulo	142
Martelli	49,113-114	NEGUS Pinze per tonsille	139
MARTIN Pinza per rifiuti	300	NEGUS Supporto de petto p.apribocca	137
MARTINI Cuchia taglienti, OTOLOGIA	42	NEIVERT Divaricatori nasale	105
MASING Elevatore nasale	101	NEIVERT Portaghi	286
MASTIN Pinza muscolare	207	NEIVERT Portaghi PROMEDUR	292
MATHIEU Divaricatori delicati	280	NEIVERT-ANDERSON Osteotomi, RINOPLASTICA	109
MATHIEU Portaghi	293	NEUROTONE-5 Diapason	22
MATHIEU Portaghi PROMEDUR	288	NEW ORLEANS Portaghi PROMEDUR	287
MATHIEU-KOCHER Portaghi PROMEDUR	288	NEWS Uncino tracheale	210
MATHIEU-SLIM Portaghi	293	NOYES Pinza per polipi nasali	77
MAUNDER Apribocca legno	128		
MAYFIELD Pinza sgorbia	67	<b>O</b>	
MAYO Clips per sterilizzazione	301	OBWEGESER Divaricatori per tessuti molli	153
MAYO Spatola per lingua	129	OBWEGESER Guancio per mento	156
MAYO-HABERISSER Pinze per ritorcere fili	167	OBWEGESER Osteotomi	165
MAYO-HEGAR Portaghi	292	OBWEGESER Periostotomi	162
MAYO-HEGAR Portaghi PROMEDUR	286	OBWEGESER Pinza perocchio in filo	166
McDONALD Dissettore doppio	101	OBWEGESER Punteruoli per mandibole	166
McGEE Pinze-piegare fili metallici	52	OBWEGESER Punteruolo per zigomi	166
McGEE Uncini, MICRO OTOLOGIA	61	OBWEGESER Separatore per ramo	154
McINDOE Cesoaia per ossa	69	OBWEGESER Separatori mandibolulari	156
McINDOE Pinza anatomiche PROMEDUR	251	OBWEGESER Separatori per ramo	154
McINDOE Scalpelli, RINOPLASTICA	111	OBWEGESER Separatori per spina nasali	154
McINTOSH laringoscopi	179,180	OBWEGESER-FREER Elevatori Maxillo-Facciale	161
McINTOSH laringoscopi a luce fredda	187-189	OCHSNER (Kocher) Pinze emostatiche	263
McIVOR Apribocca	134	OEHLER Pinze chirurgiche PROMEDUR	252
McKENTY Elevatori nasali	100	Olio per strumenti chirurgici	317
MERSHON preminastro	161	OLSEN-HEGAR Portaghi PROMEDUR	289
METZENBAUM Forbici per dissezione	228,229,232-236	OLSEN-HEGAR Portaghi	293
METZENBAUM Forbici per dissezione PROMEDUR	232-233	ORINGER Separatori per labbra	131
METZENBAUM Portaghi	292	ORL Set per diagnostica	8
METZENBAUM-BABY Forbici per dissezione	228	Osteotomi per ramo	164,165
METZENBAUM-FINO Forbici per dissezione	230,232,236	Osteotomi, MICRO OTOLOGIA	64
METZENBAUM-FINO Forbici per dissezione PROMEDUR	234,236	Osteotomi, OTOLOGIA	45,46,47,48
METZENBAUM-LAHEY Forbici per dissezione	228	Osteotomi, RINOLOGIA	108-112
METZENBAUM-X-FINO Forbici per dissezione PROMEDUR	235	Osteotomi, RINOPLASTICA	109
MICHEL Specchi per rinoscopia	172	OSTROEM Pinze per antro	84
Micro Lame per bisturi	212	OTOLOGIA	15-69
MICRO Pinze per dissezione	240	Oto-Oftalmoscopii	8-12
Micro Tijeras	222-223	Otoscopii	8-12
MICRO-ADSON Pinze anatomiche	241		
MICRO-ADSON Pinze con denti	242		

	Pagina		Pagina
<b>P</b>			
Padelle reniforme	319	Pinze per setto nasali e etmoidali	81,83
Panni di sterilizzazione verde	313	Pinze per spugni e tamponi	275-276
PAREL Intranasal Portaghi PROMEDUR	290	Pinze per tamponamento	31,77,78
PARTSCH Martelli	49, 113	Pinze per tamponi e medicature	275-276
PARTSCH Scalpelli	46	Pinze per testa del martelletto	52
PARTSCH Sgorbie	46	Pinze per tonsille	139-140
PASSOW Scalpelli per emostasi	45	Pinze per vomere e setto nasale	80
PEAN-FINO Pinze emostatiche	263	Pinze serratubi	274
PEARSON Pinza-sgorbia	66	Pinze sfenoidali	86
PECK-JOSEPH Forbici nasali	88	Pinze taglienti, RINOLOGIA	80-87
PEERS Pinza fissateli	272	Pinze tagliente e tonsillari	84
PELKMAN Pinze per tamponi e medicature	276	Pinze tendifili	167
PENNINGTON Elevatore per il setto	102	Pinze tiralingua	138
PENNINGTON Pinze per afferare argani	264	Pinze-sgorbie	66-67
Perforatori, MICRO OTOLOGIA	64	Pinzette	237-253
Periostotom per fessura del palato	163	PLESTER Cannule aspiratrice	26
Periostotomi Maxillo-Facciale	162	PLESTER Coltello per lobi	59
Periostotomi nasali	103	PLESTER Divoricatori autostatici	56,58
Periostotomi, OTOLOGIA	40,41	PLESTER Forchetta de sutura	62
PERKINS-R Divoricatori autostatici	58	PLESTER Raschiatoio	62
PERWITZSCHKY Forbici per condotto saliva	126	PLESTER Uncino per la platina dello stae	62
PETRI Scodella	318	POLITZER (Buck) bisturi falciformi	34
PIERCE Elevatore per il setto	102	POLITZER Agho per paracentesi	34
PIERCE Tre quarti per tracheotomia	93	POLITZER Specoli auricolari	16
PIFFARD curette per lupus	35	Polverizzatore	24
Pinza "Bulldog"	256	POOLE Tubi d'aspirazione	298
Pinza apri flebo	301	Portacotone	25
Pinza muscolare	207	Portaghi	284-283
Pinza per comunella	78	Portaghi per MANO SINISTRA	285,286,
Pinza per fissaggio impianti nasali	107	Portaghi per Micro-Endolaringea	199
Pinza per tessuti e cartilagine	78	Porte luce fredda per spatole	193
Pinza porta-introduci protesi	52	POTTS-SMITH Pinze anatomiche	246
Pinze anatomiche	244	POTTS-SMITH Pinze chirurgiche	248
Pinze anatomiche delicate	244	POTTS-SMITH Pinze chirurgiche PROMEDUR	250
Pinze anatomiche modello USA	244	PRATT Curetta per antro	121
Pinze anatomiche PROMEDUR	250	PRESBYTERIAN Pinze serratubi	274
Pinze atraumatiche	241,244,246,248-251	PRINCE Forbici per tonsile	141
Pinze auricolari delicate	32,50-52	Proiettore Luce Fredda Alogeno	14
Pinze chirurgiche	245,247,248,250-252	PRO-MED Pinza per fissaggio impianti nasali	107
Pinze chirurgiche modello USA	245	PRO-MED Portaghi mod. Svedese PROMEDUR	290
Pinze da presa per polipi seno mascellare	80	Protettore guidasega	120
Pinze delicate	238-243	PROVIDENCE-HOSPITAL Pinze emostatiche	259
Pinze delicate, Micro-chirurgia	239,240	Punteruoli	166
Pinze di fillaggio per teli	314	Punteruolo per mascelle	166
Pinze emostatiche	257-266		
Pinze emostatiche e per preparazione	255-269	<b>Q</b>	
Pinze fissateli	272-273	QUIRE Pinza per corpi estranei	31
Pinze fissateli per fazzoletti di carta	273		
Pinze intercambiabile per Laringo-Broncoscopia	175,176	<b>R</b>	
Pinze laringei	173	RAGNELL (Kilner) Forbici delicate PROMEDUR	231
Pinze nasali tagliente	79	RAGNELL Divaricatore delicate	280
Pinze ossivori	86,87	RANKIN-CRILE Pinze emostatiche	261
Pinze per afferare organi e tessuti	267-269	RANKIN-KELLY Pinze emostatiche	261
Pinze per afferare tessuti	264,267-269	Raspe nasali	115-119
Pinze per antro	84	Recipienti cilindrice	320
Pinze per bendaggi con recipiente	319	Recipienti per cotone usato	317
Pinze per Bronco-Esofagoscopia	177	REICHERT Depressore epiglottico	174
Pinze per corpi estranei	31	REINER-ALEXANDER Siringhe auricolari	24
Pinze per drenaggio	274	Retrattori per velo pendulo	142
Pinze per il setto nasale	79,81,123	REYNOLDS Forbici nasali	88
Pinze per intubazione	138	REYNOLDS Forbici nasali SUPERCUT	88
Pinze per la sterilizzazione	300,301	RICHNAU-HOLMGREN Specoli auricolari	17
Pinze per Laringo-Broncoscopia	178,203	RING Abassalingua	136
Pinze per legature	253,257	RINOLOGIA	71-126
Pinze per medicature, RINOLOGIA	78	RITTER-HALLE Dilatatori per seno frontale	94,296
Pinze per Micro-Endolaringea	198,199	ROCHESTER-PEAN Pinze emostatiche	263
Pinze per orologioia	240	ROEDER Serranode per tonsille	148
Pinze per piegare fili metallici	52	ROGER Elevatore tagliente	100
Pinze per polipi laringei	173,174	ROGGE Pinza per la sterilizzazione	300
Pinze per polipi nasali	77	ROSE Uncino tracheale	210
Pinze per presa gozzo	207	ROSEN Agho, MICRO OTOLOGIA	62
Pinze per rifiuti	300	ROSEN Cannule aspiratrice	27
Pinze per riposizione	169	ROSEN Coltelli, MICRO OTOLOGIA	59
Pinze per ritorcere fili	167	ROSEN Cucchiaio, MICRO OTOLOGIA	65

	Pagina		Pagina
ROSEN Elevatori, MICRO OTOLOGIA	65	Sonde di misurazione, MICRO OTOLOGIA	65
ROSEN Micro-Coltello	65	Sonde esploratrici	25, 296
ROSEN Mobilizzatore	65	Sonde per gozzo	208
ROSENBERG Pinza intercambiabile	176	Sonde per seno frontal	122
ROSER-KOENIG Apribocca	128	Sopporti per petto per laringoscopios	195
ROWE Pinze per riposizione	169	Spatole per apriboca	132-136
RUBIN Osteotomi, RINOPLASTICA	110	Spatole per lingua	128-131
RUBIN Pinza per setto nasale	123	Specchi frontali	13-14
RUMEL Pinze emostatiche	265	Specchi per rinoscopia	172
RUSSEL-DAVIS Abassalingua	136	Specchietti e manici laringei	172
RUSSEL-DAVIS Abassalingua	136	Specilli	296
RYDEL-SEIFFER Diapason	22	Specoli auricolari	16-19
		Specoli nasali	72-75
<b>S</b>		SPRAGUE Astuccio auricolare	34
SAUERBRUCH Pinza per rifiuti	300	ST.CLAIR-THOMSON Coltelli per vegetazioni adenoide	125
SAUERBRUCH Scatola per aghi	318	STACKE Sonda bottonuta, OTOLOGIA	25, 296
SAWTELL Pinze per tonsille	139	STAMMBERGER concotomi circolari, RINOLOGIA	85
Scalpelli OTOLOGIA	45,46,47,48	STEINHÄUSER Divaricatori per zigoma	152
Scalpelli per emostasi	45	STEINHÄUSER Osteotomi per ramo	164
Scalpelli per emostasi	45	STEINHÄUSER Scalpelli per ramo	164
Scalpelli per ramo	164,165	STELLBRINK Pinze-sgorbie	67
Scalpelli, RINOLOGIA	108	STERILIZZAZIONE	299-321
Scalpelli, RINOLPLASTICA	111	STERNBERG Separatori per labbra	131
Scatole per aghi	317,318	STEVENS Forbici delicate	226
Scatole per strumenti	321	STILLE Pinze anatomiche	244
SCHAEDEL Pinza fissateli	272	Strabismo, Forbici PROMEDUR	231
SCHEINMANN Pinze intercambiabile	175	STRANDELL-STILLE Divaricatori delicati	279
SCHIMMELBUSCH Cestelli rotondi per sterilizzazione	316	STRINGER stanghette per strumenti	301
SCHMEDEN Pinze nasali tagliente	81	Strisce per assicurare	314
SCHNIDT Pinze per tonsille	139	STRUEMPPEL Pinze auricolari delicate	32
SCHOEMAKER Forbici per gozzo	208	STRUMECTOMIA	207-208
SCHOENBORN divaricatore per tiroide	210	Strumentario per endoscopia orale	200-202
SCHUKNECHT Coltelli rotondi, MICRO OTOLOGIA	59	Strumenti Generali per ORL	211-298
SCHUKNECHT Divaricatore autostatico	58	Strumenti per fili d'acciaio, Cirugia Maxillo-Facciale	166
SCHUMACHER Pinza intercambiabile	176	Strumenti per Strumectomia	207-208
Scodella, PETRI	318	Strumento di misura, RINOLOGIA	120
Scodelle rotonde	319	Strumento per cartilagine	107
SEBILEAU Elevatore, OTOLOGIA	39	STRUYCKEN Pinze nasali tagliente	81
Seghe nasali	120	Supporti a molle	314
SEIFFERT Pinza intercambiabile	175	SUTURA	283-293
SEIFFERT Sonda per condotta saliva	94		
SELDIN Elevatore	161	<b>T</b>	
SEMKEN Pinze chirurgiche PROMEDUR	250	TABB Coltello per senecchia	59
SEMKEN Pinze de disezione	243	TAKAHASHI Pinze per setto nasali e etmoidali	83
SENN-GREEN Divaricatori	281	Tamponatore	144
SENN-MILLER Divaricatori	280	Tapetti porta-strumenti in silicone	313
SENN-MILLER-BABY Divaricatori delicati	280	Targhette di identificazione	311
Separatori extraorali	159	Targhette, carte con indicatore chimico	311
Separatori extraorali con luce fredda	160	TAYLOR Pinze anatomiche	247
Separatori intraorali	157,158,160	TAYLOR Pinze chirurgiche	248
Separatori mandibolulari	156	TAYLOR-CUSHING Pinze anatomiche	247
Separatori per labbra	131	TAYLOR-CUSHING Pinze chirurgiche	248
Serranodi auricolari	37	Telaio per sterilizzazione per Micro strumenti	315
Serranodi per polipi nasali	76	Tenaglia tagliafilii laterale	38,166
Serranodi per tonsille	148	Tendifili, Pinze	167
SEXTON bisturi per il timpano	34	Terminali laringei per Laringo-Broncoscopia	175,176
Sgorbie, OTOLOGIA	45,46,47,48	TESSIER Mobilizzatori	168
Sgorbie, RINOLOGIA	108,110	TESSIER Osteotomi	165
SHAMBAUGH-DERLACKI Elevatore, OTOLOGIA	39	TESSIER Periostotomi	162
SHAPLEIGH Curette auricolari	35	THIESS Martelli	49, 113
SHEA Cuchiette auricolari, MICRO OTOLOGIA	65	THUDICUM Specoli nasali	75
SHEA Separatore multiuso	160	TIECK-HALLE Specoli nasali	73
SHEA-BELLUCCI Micro-Forbici auricolari	54	TILLEY Pinza per tamponamento del orecchio	31
SHEEHAN Osteotomi, RINOLPLASTICA	112	TILLEY-HENCKEL Pinza etmoidale	84
SIEBENMANN Cannule irrigatrici	96	TIVNEN-TYDING Pinze per tonsille	140
SIEGLE Specolo auricolare pneumatico	19	TOBOLD Spatola per lingua	129
Sigilli di sicurezza	311	TOENNIS-ADSON Forbici delicate PROMEDUR	232
Silicone tapetti porta-strumenti	313	TOHOKU Pinze fissateli	273
SILVER Osteotomi, RINOPLASTICA	109	Tonsillotomi	149
Siringhe auricolari	24	TOYNBEE Specoli auricolari	16
Siringhe per irrigazione	23	TRAQUETOMIA, BOCIO	205-210
SLUDER-BALLENGER Tonsillotomo	149	Trasformatore per specchi frontali	13
Sonda per laringe	200	Trequarti per seno mascellare	93
Sonde auricolari	26	Trequarti per tracheotomia	93



	Pagina		Pagina
TROELTSCH Pinze angolate	33	WULLSTEIN Pinze auricolari delicate	50
TROELTSCH Pinze auricolari delicate	33	WULLSTEIN Pinze-cucchiaio	51
TROELTSCH Pinze per medicature	78	WULLSTEIN Tubi per aspirazione e lavaggio	29
TROELTSCH Sonde auricolari	26	WULLSTEIN-HARTMANN Pinze auricolari delicate	51
Tronchese per fili d'acciaio	38,166		
TROUSSEAU Dilatatore tracheale	207	<b>Y</b>	
Tubi d'aspirazione	297-298	YANKAUER Aghi per legatura	107
Tubi de aspirazione conico	27	YANKAUER Tubi d'aspirazione	297
Tubi di prolungamento per Laringo-Broncoscopia	175	YASARGIL Micro Forbici	223
Tubi per aspirazione e lavaggio, OTOLOGIA	26-30	YOUNG Pinza tiralingua	138
Tubi per aspirazione, Bronco-Esofagoscopia	177		
TUFFIER Pinza per tessuti e organi	264	<b>Z</b>	
TYDING Bisturi per tonsille	147	ZAUFAL Leva auricolare	35
TYDING Serranodo per tonsille	148	ZAUFAL Leva per corpi estranei	36
		ZAUFAL-JANSEN Pinza sgorbia	67
<b>U</b>		ZAUFAL-JANSEN Uncino auricolare	36
UCKERMANN Portacotone	25	ZIEGLER Specchi frontali	13
UCKERMANN Trequarto per tracheotomia	207	ZIEGLER tagliafilii PROMEDUR	167
Uncine per laringe	200	ZOELLNER Micro tubo aspiratrice	27
Uncini auricliari	36	ZOELLNER Specoli auricolari	17
Uncini delicati	278-281		
Uncini delicati, RINOLOGIA	104-106		
Uncini per Microlaringologia	200		
Uncini tracheali	209-210,278		
Uncini, MICRO OTOLOGIA	61,62		
UNIV.MINNESOTA Spatola per lingua	129		
UNIVERSAL Forbici per fili metallici PROMEDUR	37		
UNIVERSAL tenaglia tagliafilii	38		
USA-MODELO Pinze serratubi	274		
<b>V</b>			
VANNAS Micro Forbici	223		
Vassoi per strumenti	321		
VISE Micro-Pinze per legature	253		
VOLKMANN Cuchiaii taglienti, OTOLOGIA	44		
<b>W</b>			
WAGENER Uncini auricliari	36		
WALKER Forbici delicate	225		
WALSHAM Pinze per il setto nasale	123		
WALTER Divaricatore nasale	106		
WALTER Osteotomi, RINOPLASTICA	110		
WALTER Sgorbie, RINOPLASTICA	110		
WALTON Pinze per tamponi e medicature	275		
WANGENSTEEN Pinza chirurgiche PROMEDUR	250		
WATSON-CHEYNE Elevatore nasale	101		
WATSON-CHEYNE Sonde nasali	102		
WATSON-WILLIAMS Concotomi	81		
WATSON-WILLIAMS Pinza per afferare	79		
WATSON-WILLIAMS Pinze nasali tagliante	79		
WAUGH Pinze anatomiche	247		
WEBSTER Portaghi	291		
WEBSTER Portaghi PROMEDUR	285		
WEIL-BLAKESLEY Pinze per setto nasali e etmoidali	82,83		
WHITE Pinze per tonsille	139		
WHITEHEAD Apribocca	132		
WIBERG Periostotomi	103		
WIEDER Spatole per lingua	130		
WIENER Raspe per antro	118		
WIENER Specoli nasali	72		
WILDE Pinza angolate	33		
WILDE Serranode auricolare	37		
WILDE Serranode per polipi nasali	76		
WILLIGER Cuchiaii taglienti, OTOLOGIA	43		
WILLIGER Elevatore, OTOLOGIA	39		
WILLIGER Martello	49, 113		
WILLIGER Periostotomi, OTOLOGIA	40		
WILLIGER Uncini auricolari	36		
WISCONSIN-FOREGGER laringoscopi	185		
WULLSTEIN Cannule aspiratrice	26		
WULLSTEIN Divoricatori autostatici	57		
WULLSTEIN Manici d'aspirazione	26,29		
WULLSTEIN Micro-Forbici auricolari	53		

Kat.Nr. Cat.No. No. Réf. No. Ref. No. Ref.	Seite Page Page Página Pagina	Kat.Nr. Cat.No. No. Réf. No. Ref. No. Ref.	Seite Page Page Página Pagina	Kat.Nr. Cat.No. No. Réf. No. Ref. No. Ref.	Seite Page Page Página Pagina	Kat.Nr. Cat.No. No. Réf. No. Ref. No. Ref.	Seite Page Page Página Pagina
<b>10...</b>		11.1131.....	186	12.0113.....	215	13.0070.....	226
10.0102.....	8	11.1132.....	186	12.0114.....	219	13.0071.....	226
10.0105.....	9	11.1133.....	186	12.0115.....	216	13.0076.....	226
10.0106.....	10	11.1134.....	186	12.0117.....	219	13.0077.....	226
10.0108.....	10	11.2003.....	187	12.0123.....	216	13.0078.....	226
10.0110.....	11	11.2004.....	187	12.0125.....	216	13.0079.....	226
10.0120.....	11	11.2016.....	187,188, 189,190	12.0127.....	215	13.0080.....	226
10.0135.....	12	11.2018.....	188,190	12.0133.....	216	13.0080SC.....	226
10.0137.....	12	11.2020.....	188	12.0153.....	212	13.0081.....	226
10.0700.....	13	11.2021.....	187,188	12.0157.....	212	13.0081SC.....	226
10.0707.....	13	11.2022.....	187,188	12.0163.....	216	13.0082.....	226
10.0709.....	13	11.2023.....	187,188	12.0173.....	216	13.0082SC.....	226
10.0730.....	13	11.2024.....	187,188	12.0174.....	219	13.0083.....	226
10.0731.....	13	11.2063.....	189	12.0180.....	212	13.0083SC.....	226
10.0737.....	13	11.2064.....	189	12.0182.....	212	13.0130.....	226
10.0739.....	13	11.2070.....	190	12.0184.....	212	13.0131.....	226
10.0750.....	13	11.2071.....	189,190	12.0186.....	212	13.0140.....	226
10.0760.....	14	11.2072.....	189,190	12.0188.....	212	13.0140SC.....	226
10.0761.....	14	11.2073.....	189,190	12.0190.....	214	13.0141.....	226
10.0762.....	14	11.2074.....	189,190	12.0191.....	214	13.0141SC.....	226
10.0763.....	14			12.0192.....	214	13.0146.....	226
10.0769.....	14			12.0195.....	214	13.0147.....	226
10.0790.....	14	<b>12...</b>		12.0196.....	214	13.0152.....	227
10.2000.....	14	12.0010.....	213	12.0197.....	214	13.0153.....	227
		12.0011.....	213			13.0154.....	227
<b>11...</b>		12.0012.....	213	<b>13...</b>		13.0155.....	227
11.0100.....	138	12.0013.....	213	13.0010.....	224	13.0162.....	227
11.0110.....	138	12.0014.....	213	13.0010SC.....	224	13.0163.....	227
11.0119.....	138	12.0015.....	213	13.0011.....	224	13.0164.....	227
11.0300.....	138	12.0016.....	213	13.0011SC.....	224	13.0165.....	227
11.0302.....	138	12.0017.....	213	13.0012.....	224	13.0172.....	227
11.0304.....	138	12.0018.....	217	13.0012L.....	224	13.0173.....	227
11.1002.....	179	12.0019.....	217	13.0012LSC.....	224	13.0174.....	227
11.1003.....	179	12.0020.....	217	13.0012SC.....	224	13.0175.....	227
11.1004.....	180	12.0021.....	217	13.0013.....	224	13.0594.....	228
11.1005.....	180	12.0022.....	217	13.0013L.....	224	13.0594SC.....	228
11.1016.....	181,184	12.0023.....	217	13.0013LSC.....	224	13.0595.....	228
11.1017.....	181	12.0024.....	217	13.0013SC.....	224	13.0595SC.....	228
11.1018.....	181	12.0025.....	217	13.0014.....	224	13.0596.....	228
11.1019.....	181	12.0034.....	217	13.0014SC.....	224	13.0597.....	228
11.1020.....	182	12.0036.....	217	13.0015.....	224	13.0597SC.....	228
11.1021.....	182	12.0042.....	217	13.0015SC.....	224	13.0598.....	228
11.1022.....	182	12.0044.....	217	13.0016.....	224	13.0598SC.....	228
11.1023.....	182	12.0045.....	217	13.0017.....	224	13.0599.....	228
11.1024.....	182	12.0046.....	217	13.0018.....	224	13.0599SC.....	228
11.1027.....	179,187	12.0060.....	217	13.0019.....	224	13.0600.....	228
11.1028.....	180	12.0061.....	212	13.0022.....	224	13.0600L.....	228
11.1029.....	180	12.0062.....	212	13.0023.....	224	13.0600SC.....	228
11.1052.....	182	12.0062S.....	212	13.0032.....	225	13.0601.....	228
11.1063.....	183	12.0064.....	212	13.0033.....	225	13.0601L.....	228
11.1070.....	182,184	12.0065.....	212	13.0041.....	225	13.0601SC.....	228
11.1071.....	182,184	12.0067.....	212	13.0043.....	225	13.0602.....	229
11.1072.....	184	12.0069.....	212	13.0043SC.....	225	13.0602L.....	229
11.1073.....	184	12.0070.....	219	13.0045.....	225	13.0602SC.....	229
11.1074.....	184	12.0101.....	215	13.0051.....	225	13.0603.....	229
11.1103.....	185	12.0102.....	218	13.0053.....	225	13.0603L.....	229
11.1104.....	185	12.0103.....	215	13.0055.....	225	13.0603SC.....	229
11.1111.....	185	12.0104.....	218	13.0060.....	225	13.0604.....	229
11.1112.....	185	12.0105.....	218	13.0060SC.....	225	13.0604SC.....	229
11.1113.....	185	12.0106.....	215	13.0061.....	225	13.0605.....	229
11.1114.....	185	12.0107.....	215	13.0061SC.....	225	13.0605SC.....	229
11.1123.....	186	12.0108.....	215	13.0062.....	225	13.0606.....	229
11.1124.....	186	12.0109.....	218	13.0063.....	225	13.0606SC.....	229

Kat.Nr. Cat.No. No. Réf. No. Ref.	Seite Page Page Página Pagina	Kat.Nr. Cat.No. No. Réf. No. Ref.	Seite Page Page Página Pagina	Kat.Nr. Cat.No. No. Réf. No. Ref.	Seite Page Page Página Pagina	Kat.Nr. Cat.No. No. Réf. No. Ref.	Seite Page Page Página Pagina
13.0607	229	13.0676	230	13.5000	231	14.0107	244
13.0607SC	229	13.0677	230	13.5001	231	14.0108	244
13.0608	229	13.0683	230	13.5007	231	14.0111	244
13.0608SC	229	13.0685	230	13.5010	231	14.0112	244
13.0609	229	13.0687	230	13.5011	231	14.0113	244
13.0609L	229	13.0693	230	13.5020	231	14.0114	244
13.0609SC	229	13.0695	230	13.5021	231	14.0115	244
13.0610	229	13.0697	230	13.5030	231	14.0116	244
13.0610SC	229	13.0752	228	13.5031	231	14.0117	244
13.0611	229	13.0753	228	13.5041	231	14.0120	244
13.0611SC	229	13.0770	88	13.5291	232	14.0121	244
13.0612	229	13.0770SC	88	13.5298	232	14.0122	244
13.0612SC	229	13.0771	88	13.5299	232	14.0123	244
13.0613	229	13.0771SC	88	13.5300	232	14.0124	244
13.0613SC	229	13.0772	88	13.5301	232	14.0125	244
13.0620	228	13.0773	88	13.5304	234	14.0127	244
13.0621	228	13.0775	88	13.5305	234	14.0128	244
13.0622	229	13.0779	88	13.5308	235	14.0142	244
13.0623	229	13.0780	88	13.5309	235	14.0143	244
13.0624	229	13.0780SC	88	13.5310	233	14.0144	244
13.0625	229	13.0781	88	13.5311	233	14.0151	244
13.0626	229	13.0781SC	88	13.5313	236	14.0152	244
13.0627	229	13.0790	88	13.5314	234	14.0153	244
13.0628	229	13.0791	88	13.5315	234	14.0154	244
13.0629	229	13.0792	88	13.5317	236	14.0155	244
13.0630	229	13.0793	88	13.5318	235	14.0157	244
13.0631	229	13.0840	89	13.5319	235	14.0158	244
13.0642	229	13.0842	89	13.5320	233	14.0181	244
13.0643	229	13.2400	37	13.5321	233	14.0182	244
13.0644	229	13.2401	37	13.5323	236	14.0183	244
13.0644SC	229	13.2404	38	13.5324	234	14.0184	244
13.0645	229	13.2420	38	13.5325	234	14.0187	244
13.0645SC	229	13.2421	38	13.5327	236	14.0188	244
13.0646	229	13.2424	38	13.5328	235	14.0202	244
13.0647	229	13.2425	38	13.5329	235	14.0204	244
13.0648	229	13.2700	89	13.5330	233	14.0207	244
13.0649	229	13.2705	89	13.5331	233	14.0220	244
13.0650	229	13.2726	89	13.5333	236	14.0300	244
13.0650SC	229	13.2726SC	89	13.5337	236	14.0301	244
13.0651	229	13.2739	90	13.5401	37	14.0310	246
13.0651SC	229	13.2740	90	13.5812	92	14.0311	246
13.0660	230	13.2750	90	13.5813	92	14.0320	246
13.0660SC	230	13.2750SC	90	13.5901	92,141	14.0321	246
13.0661	230	13.2750Z	90	13.5903	92,141	14.0325	246
13.0661SC	230	13.2757	90			14.0328	246
13.0662	230	13.2770	91	<b>14...</b>		14.0350	246
13.0662SC	230	13.2771	91	14.0010	238	14.0352	246
13.0663	230	13.2773	91	14.0011	238	14.0354	246
13.0663SC	230	13.2791	91	14.0013	238	14.0360	247
13.0664	230	13.2793	91	14.0026	241	14.0361	247
13.0664SC	230	13.2800	91	14.0028	241	14.0362	247
13.0665	230	13.2801	91	14.0030	241	14.0365	247
13.0665SC	230	13.2811	91	14.0032	241	14.0368	247
13.0666	230	13.2890	141	14.0040	241	14.0370	247
13.0666SC	230	13.2901	141	14.0042	241	14.0380	240
13.0667	230	13.2903	141	14.0049	241	14.0382	240
13.0667SC	230	13.2925	141	14.0050	241	14.0384	240
13.0670	230	13.2930	141	14.0100	244	14.0510	239
13.0671	230	13.2932	141	14.0101	244	14.0511	239
13.0672	230	13.2941	141	14.0102	244	14.0513	239
13.0673	230	13.3010	141	14.0103	244	14.0526	242
13.0674	230	13.3014	141	14.0104	244	14.0527	242
13.0675	230	13.3014SC	141	14.0105	244	14.0528	242

Kat.Nr. Cat.No. No. Réf. No. Ref. No. Ref.	Seite Page Page Página Pagina	Kat.Nr. Cat.No. No. Réf. No. Ref. No. Ref.	Seite Page Page Página Pagina	Kat.Nr. Cat.No. No. Réf. No. Ref. No. Ref.	Seite Page Page Página Pagina	Kat.Nr. Cat.No. No. Réf. No. Ref. No. Ref.	Seite Page Page Página Pagina
14.0530	242	14.0821	247	14.2123	250	15.0218	260
14.0532	242	14.0825	247	14.2125	250	15.0220	260
14.0540	242	14.0850	248	14.2127	250	15.0222	260
14.0541	242	14.0851	248	14.2128	250	15.0224	260
14.0542	242	14.0852	248	14.2170	251	15.0225	260
14.0543	242	14.0853	248	14.2200	251	15.0230	260
14.0545	242	14.0860	248	14.2202	251	15.0231	260
14.0546	241	14.0861	248	14.2210	251	15.0236	260
14.0547	241	14.0862	248	14.2212	251	15.0237	260
14.0548	243	14.0865	248	14.2230	251	15.0240	261
14.0549	242	14.1000	249	14.2232	251	15.0241	261
14.0550	243	14.1002	249	14.2240	251	15.0250	261
14.0554	243	14.1010	249	14.2242	251	15.0251	261
14.0556	243	14.1010T	249	14.2320	251	15.0252	261
14.0560	243	14.1012	249	14.2390	251	15.0253	261
14.0561	243	14.1012T	249	14.2570	251	15.0260	261
14.0562	243	14.1021	249	14.2623	252	15.0261	261
14.0563	243	14.1021T	249	14.2625	252	15.0262	261
14.0566	243	14.1023	249	14.2627	252	15.0263	261
14.0570	243	14.1023T	249	14.2628	252	15.0300	262
14.0600	245	14.1030	249	14.2820	251	15.0301	262
14.0601	245	14.1030T	249	14.2890	252	15.0302	262
14.0602	245	14.1032	249	14.2900	252	15.0303	262
14.0603	245	14.1032T	249			15.0306	262
14.0604	245	14.1060	248	<b>15...</b>		15.0307	262
14.0605	245	14.1060T	248	15.0098	257	15.0308	262
14.0607	245	14.1062	248	15.0100	257	15.0309	262
14.0608	245	14.1062T	248	15.0101	257	15.0310	262
14.0620	245	14.1070	249	15.0102	257	15.0311	262
14.0621	245	14.1072	249	15.0103	257	15.0313	262
14.0622	245	14.1100	253	15.0104	257	15.0315	262
14.0623	245	14.1102	253	15.0105	257	15.0316	262
14.0624	245	14.1110	253	15.0108	257	15.0317	262
14.0625	245	14.1112	253	15.0116	258	15.0450	263
14.0627	245	14.1113	253	15.0117	258	15.0451	263
14.0628	245	14.1120	253	15.0120	258	15.0452	263
14.0629	245	14.1121	253	15.0120L	258	15.0453	263
14.0653	245	14.1122	253	15.0121	258	15.0454	263
14.0657	245	14.1600	240	15.0121L	258	15.0455	263
14.0681	245	14.1602	240	15.0122	258	15.0458	263
14.0682	245	14.1603	240	15.0123	258	15.0459	263
14.0683	245	14.1604	240	15.0124	258	15.0460	263
14.0684	245	14.1605	240	15.0125	258	15.0461	263
14.0687	245	14.1607	240	15.0126	258	15.0462	263
14.0701	245	14.1614	240	15.0127	258	15.0463	263
14.0702	245	14.1617	240	15.0128	258	15.0463	263
14.0703	245	14.2000	250	15.0129	258	15.0464	263
14.0704	245	14.2001	250	15.0130	259	15.0465	263
14.0705	245	14.2002	250	15.0131	259	15.0600	263
14.0707	245	14.2005	250	15.0136	258	15.0601	263
14.0708	245	14.2007	250	15.0137	258	15.0602	263
14.0722	245	14.2010	250	15.0139	258	15.0603	263
14.0723	245	14.2020	250	15.0180	259	15.0604	263
14.0724	245	14.2021	250	15.0181	259	15.0605	263
14.0725	245	14.2023	250	15.0200	259	15.0606	263
14.0727	245	14.2049	250	15.0201	259	15.0607	263
14.0728	245	14.2050	250	15.0210	259	15.0608	263
14.0780	239	14.2070	250	15.0211	259	15.0609	263
14.0782	239	14.2103	250	15.0211	259	15.0731	265
14.0784	239	14.2105	250	15.0212	259	15.0732	265
14.0800	247	14.2107	250	15.0213	259	15.0733	265
14.0801	247	14.2108	250	15.0214	259	15.0734	265
14.0820	247	14.2122	250	15.0215	259	15.0741	265





Kat.Nr. Cat.No. No. Réf. No. Ref. No. Ref.	Seite Page Page Página Pagina	Kat.Nr. Cat.No. No. Réf. No. Ref. No. Ref.	Seite Page Page Página Pagina	Kat.Nr. Cat.No. No. Réf. No. Ref. No. Ref.	Seite Page Page Página Pagina	Kat.Nr. Cat.No. No. Réf. No. Ref. No. Ref.	Seite Page Page Página Pagina
18.1015	291	19.0710	297	23.1054	44	23.1497	47
18.1020	291	19.0715	297	23.1055	44	23.1498	47
18.1025	291	19.0720	298	23.1056	44	23.1499	47
18.1026	291	19.0721	298	23.1057	44	23.1630	48
18.1030	291	19.0726	298	23.1058	44	23.1631	48
18.1035	291	19.0727	298	23.1059	44	23.1632	48
18.1040	291	19.1050	93	23.1280	49, 113	23.1633	48
18.1050	292	19.1220	93	23.1281	49, 113	23.1634	48
18.1060	292	19.1300	93	23.1290	49, 113	23.1640	48
18.1065	292	19.1310	93	23.1300	49, 113	23.1641	48
18.1070	292	19.1311	93	23.1302	49, 113	23.1642	48
18.1072	292	19.1312	93	23.1304	49, 113	23.1643	48
18.1078	292	19.1320	94	23.1305	49, 114	23.1644	48
18.1080	292			23.1306	49, 114	23.1680	48
18.1082	292	<b>23...</b>		23.1310	49, 114	23.1681	48
18.1100	292	23.0020	39	23.1311	49, 114	23.1682	48
18.1250	293	23.0022	39	23.1315	49, 114	23.1683	48
18.1252	293	23.0028	39	23.1410	46	23.1684	48
18.1260	293	23.0029	39	23.1411	46	23.1685	48
18.1262	293	23.0030	39	23.1412	46	23.1902	45
18.1270	293	23.0421	41	23.1413	46	23.1903	45
18.1272	293	23.0500	40	23.1414	46	23.1904	45
18.1320	293	23.0502	40	23.1415	46	23.1912	45
18.1322	293	23.0505	40	23.1416	46	23.1913	45
18.1330	293	23.0506	41	23.1440	46	23.1914	45
18.1330L	293	23.0508	41	23.1441	46	23.2600	66
18.1332	293	23.0515	40	23.1442	46	23.2601	66
18.1334	293	23.0516	40	23.1443	46	23.2602	66
18.1336	293	23.0517	40	23.1444	46	23.2603	66
18.1800	284	23.0520	41	23.1445	46	23.2606	66
18.1801	284	23.0521	41	23.1446	46	23.2607	66
18.1802	284	23.0525	41	23.1458	47	23.2609	66
18.1803	284	23.0527	41	23.1459	47	23.2611	66
18.1810	284	23.0529	41	23.1460	47	23.2620	67
18.1811	284	23.0842	45	23.1461	47	23.2621	67
18.1812	284	23.0843	45	23.1462	47	23.2627	67
18.1813	284	23.0844	45	23.1463	47	23.2629	67
18.3160	107	23.0845	45	23.1464	47	23.2802	67
		23.0846	45	23.1468	47	23.2803	67
		23.0848	45	23.1469	47	23.2831	67
<b>19...</b>		23.0850	45	23.1470	47	23.2833	67
19.0249	25, 296	23.0860	45	23.1471	47	23.2835	67
19.0250	25, 296	23.0862	45	23.1472	47	23.3005	68
19.0252	25, 296	23.1020	44	23.1473	47	23.3020	68
19.0500	25	23.1021	44	23.1474	47	23.3050	68
19.0501	25	23.1022	44	23.1478	47	23.3052	68
19.0502	25	23.1023	44	23.1479	47	23.3054	68
19.0503	25	23.1025	44	23.1480	47	23.3056	68
19.0510	25	23.1026	44	23.1481	47	23.3100	69
19.0511	25	23.1027	44	23.1482	47	23.3101	69
19.0512	25	23.1028	44	23.1483	47	23.3111	69
19.0513	25	23.1030	42	23.1484	47	23.4004	166
19.0520	25	23.1031	42	23.1486	47	23.4005	166
19.0521	25	23.1032	42	23.1487	47	23.4130	38
19.0522	25	23.1036	43	23.1488	47	23.4135	38, 166
19.0523	25	23.1037	43	23.1489	47	23.4150	38
19.0530	25	23.1040	43	23.1490	47	23.4170	167
19.0531	25	23.1041	43	23.1491	47	23.4220	167
19.0532	25	23.1042	43	23.1492	47	23.4221	167
19.0533	25	23.1050	44	23.1493	47		
19.0540	25	23.1051	44	23.1494	47	<b>27...</b>	
19.0550	25	23.1052	44	23.1495	47	27.0070	28
19.0553	25	23.1053	44	23.1496	47	27.0071	28
19.0700	297						

Kat.Nr. Cat.No. No. Réf. No. Ref. No. Ref.	Seite Page Page Página Pagina	Kat.Nr. Cat.No. No. Réf. No. Ref. No. Ref.	Seite Page Page Página Pagina	Kat.Nr. Cat.No. No. Réf. No. Ref. No. Ref.	Seite Page Page Página Pagina	Kat.Nr. Cat.No. No. Réf. No. Ref. No. Ref.	Seite Page Page Página Pagina
27.0072	28	28.2720	223	32.0027	16	32.0129	17
27.0073	28	28.2721	223	32.0051	16	32.0129B	17
27.0074	28	28.2722	223	32.0052	16	32.0130	17
27.0075	28	28.2723	223	32.0053	16	32.0130B	17
27.0076	28			32.0054	16	32.0131	17
27.0077	28	<b>30...</b>		32.0056	16	32.0131B	17
27.0078	28	30.1700	296	32.0057	16	32.0132	17
27.0079	28	30.1701	296	32.0061	16	32.0132B	17
27.0089	28	30.1702	296	32.0062	16	32.0133	17
27.0090	29	30.1703	296	32.0063	16	32.0133B	17
27.0091	29	30.1704	296	32.0064	16	32.0134	17
27.0094	29	30.1705	296	32.0065	16	32.0134B	17
27.0096	29	30.1706	296	32.0071	16	32.0135	17
27.0098	29	30.1707	296	32.0072	16	32.0135B	17
27.0152	29	30.1708	296	32.0073	16	32.0136	17
27.0154	29	30.1738	296	32.0074	16	32.0136B	17
27.0156	29	30.1740	296	32.0075	16	32.0137	17
27.0170	29	30.1741	296	32.0076	16	32.0137B	17
27.0171	29	30.1742	296	32.0101	17	32.0138	17
27.0172	29	30.1743	296	32.0102	17	32.0138B	17
27.0173	29	30.1744	296	32.0103	17	32.0139	17
27.0174	29	30.1745	296	32.0104	17	32.0139B	17
27.0175	29	30.1746	296	32.0105	17	32.0140	17
27.0176	29	30.1747	296	32.0106	17	32.0140B	17
27.0176E	29	30.1748	296	32.0108	17	32.0141	17
27.0179	29	30.1760	296	32.0110	17	32.0141B	17
27.0180	30	30.1761	296	32.0110B	17	32.0142	17
27.0181	30	30.1762	296	32.0111	17	32.0142B	17
27.0181E	30	30.1763	296	32.0111B	17	32.0143	17
27.0182	30	30.1764	296	32.0112	17	32.0143B	17
27.0183	30	30.1765	296	32.0112B	17	32.0144	17
27.0183E	30	30.2000	238	32.0113	17	32.0144B	17
27.0184	30	30.2000T	238	32.0113B	17	32.0145	17
27.0185	30	30.2001	238	32.0114	17	32.0145B	17
27.0185E	30	30.2001T	238	32.0114B	17	32.0146	17
27.0186	30	30.2003	238	32.0115	17	32.0146B	17
27.0187	30	30.2003T	238	32.0115B	17	32.0147	17
27.0190	30	30.2004	238	32.0116	17	32.0147B	17
27.0191	30	30.2005	238	32.0116B	17	32.0148	17
27.0192	30	30.2007	238	32.0117	17	32.0148B	17
27.0193	30	30.2009	238	32.0117B	17	32.0149	17
27.0194	30	30.2010	239	32.0118	17	32.0149B	17
27.0195	30	30.2011	239	32.0118B	17	32.0150	17
27.0196	30	30.2013	239	32.0119	17	32.0151	17
27.0199	30	30.2014	239	32.0119B	17	32.0152	17
27.0705	18	30.2015	239	32.0120	17	32.0153	17
27.0708	18	30.2017	239	32.0120B	17	32.0200	19
				32.0121	17	32.0201	19
<b>28...</b>		<b>32...</b>		32.0121B	17	32.0202	19
28.2120	222	32.0001	16	32.0122	17	32.0203	19
28.2121	222	32.0002	16	32.0122B	17	32.0204	19
28.2122	222	32.0003	16	32.0123	17	32.0205	19
28.2123	222	32.0004	16	32.0123B	17	32.0206	19
28.2133	222	32.0005	16	32.0124	17	32.0210	19
28.2711	223	32.0006	16	32.0124B	17	32.0213	19
28.2712	223	32.0007	16	32.0125	17	32.0214	19
28.2713	223	32.0008	16	32.0125B	17	32.0215	19
28.2714	223	32.0009	16	32.0126	17	32.0216	19
28.2715	223	32.0021	16	32.0126B	17	32.0218	19
28.2716	223	32.0022	16	32.0127	17	32.0219	19
28.2717	223	32.0023	16	32.0127B	17	32.0220	18
28.2718	223	32.0024	16	32.0128	17	32.0229	18
28.2719	223	32.0026	16	32.0128B	17	32.0280	23

Kat.Nr. Cat.No. No. Réf. No. Ref.	Seite Page Page Página	Kat.Nr. Cat.No. No. Réf. No. Ref.	Seite Page Page Página	Kat.Nr. Cat.No. No. Réf. No. Ref.	Seite Page Page Página	Kat.Nr. Cat.No. No. Réf. No. Ref.	Seite Page Page Página
32.0281	23	32.0741	32	32.1115	42	32.1363	36
32.0282	23	32.0743	32	32.1128	42	32.1364	36
32.0283	23	32.0801	50	32.1129	42	32.1365	36
32.0284	23	32.0805	50	32.1130	42	32.1366	36
32.0285	23	32.0806	50	32.1131	42	32.1367	36
32.0286	23	32.0807	50	32.1132	42	32.1368	36
32.0287	23	32.0808	50	32.1133	42	32.1376	36
32.0288	23	32.0809	50	32.1134	42	32.1377	36
32.0289	23	32.0810	50	32.1135	42	32.1378	36
32.0296	23	32.0811	50	32.1150	42	32.1380	36
32.0297	23	32.0812	50	32.1151	42	32.1382	36
32.0301	24	32.0813	50	32.1152	42	32.1400	36
32.0302	24	32.0814	50	32.1153	42	32.1402	36
32.0303	24	32.0815	51	32.1160	26	32.1410	36
32.0320	24	32.0816	51	32.1161	26	32.1411	36
32.0340	24	32.0817	51	32.1162	26	32.1413	36
32.0400	20	32.0818	51	32.1163	26	32.1510	39
32.0401	20	32.0819	51	32.1166	26	32.1520	39
32.0402	20	32.0820	51	32.1167	26	32.1521	39
32.0403	20	32.0825	51	32.1168	26	32.1523	39
32.0404	20	32.0826	51	32.1169	26	32.1530	40
32.0409	20	32.0830	52	32.1170	27	32.1531	40
32.0410	21	32.0832	52	32.1171	27	32.1532	40
32.0411	21	32.0840	52	32.1172	27	32.1533	40
32.0412	21	32.0850	52	32.1173	27	32.1534	40
32.0413	21	32.0852	52	32.1174	27	32.1535	40
32.0414	21	32.0860	52	32.1175	27	32.1537	40
32.0415	21	32.0900	53	32.1177	27	32.1700	37
32.0419	21	32.0901	53	32.1178	27	32.1706	37
32.0424	22	32.0902	53	32.1179	27	32.1707	37
32.0426	22	32.0903	53	32.1180	27	32.1709	37
32.0430	22	32.0905	53	32.1181	27	32.1710	37
32.0431	22	32.0906	53	32.1185	27	32.2500	59
32.0434	22	32.0907	53	32.1187	27	32.2501	59
32.0450	22	32.0908	53	32.1188	27	32.2511	59
32.0600	31	32.0910	54	32.1189	27	32.2521	59
32.0610	31	32.0911	54	32.1190	27	32.2531	59
32.0612	31	32.0912	54	32.1191	27	32.2540	59
32.0615	31	32.0913	54	32.1193	27	32.2544	59
32.0620	31	32.1001	26	32.1194	27	32.2545	59
32.0630	31	32.1002	26	32.1195	27	32.2550	60
32.0636	35	32.1003	26	32.1200	34	32.2551	60
32.0640	33	32.1004	26	32.1201	34	32.2552	60
32.0641	33	32.1005	26	32.1202	34	32.2553	60
32.0642	33	32.1021	26	32.1204	34	32.2554	60
32.0644	33	32.1022	26	32.1212	34	32.2555	60
32.0650	33	32.1023	26	32.1214	34	32.2556	60
32.0660	33	32.1024	26	32.1220	34	32.2560	59
32.0662	33	32.1025	26	32.1250	34	32.2561	60
32.0700	32	32.1100	44	32.1300	35	32.2563	60
32.0701	32	32.1101	44	32.1302	35	32.2564	60
32.0702	32	32.1102	44	32.1304	35	32.2566	60
32.0705	32	32.1103	44	32.1310	35	32.2750	61
32.0706	32	32.1104	44	32.1315	35	32.2751	61
32.0707	32	32.1105	44	32.1320	35	32.2752	61
32.0710	32	32.1106	44	32.1350	35	32.2760	61
32.0712	32	32.1108	42	32.1351	35	32.2761	61
32.0714	32	32.1109	42	32.1352	35	32.2762	61
32.0715	32	32.1110	42	32.1356	35	32.2763	61
32.0720	32	32.1111	42	32.1357	35	32.2764	61
32.0730	32	32.1112	42	32.1360	35	32.2765	61
32.0735	32	32.1113	42	32.1361	36	32.2766	61
32.0740	32	32.1114	42	32.1362	36	32.2770	61



Kat.Nr. Cat.No. No. Réf. No. Ref. No. Ref.	Seite Page Page Página Pagina	Kat.Nr. Cat.No. No. Réf. No. Ref. No. Ref.	Seite Page Page Página Pagina	Kat.Nr. Cat.No. No. Réf. No. Ref. No. Ref.	Seite Page Page Página Pagina	Kat.Nr. Cat.No. No. Réf. No. Ref. No. Ref.	Seite Page Page Página Pagina
32.2771.....	61	<b>33...</b>		33.0467.....	78	33.0757.....	85
32.2772.....	61	33.0010.....	72	33.0600.....	79	33.0762.....	83
32.2773.....	61	33.0011.....	72	33.0601.....	79	33.0763.....	83
32.2774.....	61	33.0012.....	72	33.0602.....	79	33.0764.....	83
32.2775.....	61	33.0015.....	72	33.0603.....	79	33.0765.....	83
32.2776.....	61	33.0016.....	72	33.0610.....	79	33.0800.....	86
32.2781.....	61	33.0017.....	72	33.0611.....	79	33.0801.....	86
32.2782.....	61	33.0020.....	72	33.0612.....	79	33.0802.....	86
32.2800.....	61	33.0021.....	72	33.0615.....	79	33.0803.....	86
32.2801.....	61	33.0022.....	72	33.0616.....	79	33.0810.....	86
32.2802.....	61	33.0025.....	72	33.0617.....	79	33.0812.....	86
32.2805.....	61	33.0030.....	73	33.0618.....	79	33.0815.....	86
32.2806.....	61	33.0032.....	73	33.0620.....	80	33.0817.....	86
32.2807.....	61	33.0035.....	73	33.0621.....	80	33.0830.....	87
32.2811.....	61	33.0040.....	73	33.0625.....	80	33.0840.....	87
32.2813.....	61	33.0041.....	73	33.0626.....	80	33.0841.....	87
32.2816.....	61	33.0042.....	73	33.0640.....	80	33.0842.....	87
32.2818.....	61	33.0043.....	73	33.0641.....	80	33.0850.....	87
32.2830.....	62	33.0051.....	73	33.0643.....	80	33.1000.....	76
32.2837.....	62	33.0052.....	73	33.0650.....	80	33.1005.....	76
32.2840.....	62	33.0053.....	73	33.0651.....	80	33.1010.....	76
32.2850.....	62	33.0055.....	74	33.0652.....	80	33.1093.....	76
32.2851.....	62	33.0055S.....	74	33.0653.....	80	33.1094.....	76
32.2852.....	62	33.0056.....	74	33.0680.....	81	33.1095.....	76
32.2855.....	62	33.0056S.....	74	33.0690.....	81	33.1096.....	76
32.2856.....	62	33.0057.....	74	33.0700.....	81	33.1100.....	93
32.2857.....	62	33.0057S.....	74	33.0710.....	81	33.1101.....	93
32.2860.....	62	33.0058.....	74	33.0711.....	81	33.1102.....	93
32.2861.....	62	33.0058S.....	74	33.0715.....	81	33.1103.....	93
32.2862.....	62	33.0059.....	74	33.0716.....	81	33.1104.....	93
32.2865.....	62	33.0060.....	74	33.0717.....	81	33.1115.....	94
32.2866.....	62	33.0061.....	74	33.0718.....	81	33.1120.....	94,296
32.2867.....	62	33.0081.....	75	33.0719.....	81	33.1122.....	94,296
32.2871.....	62	33.0082.....	75	33.0721.....	82	33.1124.....	94,296
32.2872.....	62	33.0083.....	75	33.0722.....	82	33.1125.....	94,296
32.2900.....	63	33.0084.....	75	33.0723.....	82	33.1130.....	94
32.2901.....	63	33.0085.....	75	33.0724.....	82	33.1131.....	94
32.2902.....	63	33.0086.....	75	33.0725.....	82	33.1132.....	94
32.2903.....	63	33.0087.....	75	33.0726.....	82	33.1135.....	94
32.2910.....	64	33.0090.....	75	33.0727.....	82	33.1136.....	94
32.2911.....	64	33.0091.....	75	33.0728.....	82	33.1137.....	94
32.2912.....	64	33.0092.....	75	33.0729.....	82	33.1151.....	94
32.2918.....	64	33.0100.....	75	33.0730.....	82	33.1152.....	94
32.2920.....	64	33.0101.....	75	33.0732.....	83	33.1153.....	94
32.2923.....	64	33.0102.....	75	33.0733.....	83	33.1154.....	95
32.2924.....	64	33.0222.....	92	33.0734.....	83	33.1155.....	95
32.2925.....	64	33.0250.....	92	33.0735.....	83	33.1156.....	95
32.2926.....	64	33.0400.....	77	33.0737.....	83	33.1160.....	95,297
32.2927.....	64	33.0402.....	77	33.0739.....	83	33.1161.....	95
32.2928.....	64	33.0410.....	77	33.0741.....	82	33.1162.....	95
32.2950.....	65	33.0420.....	77	33.0742.....	82	33.1164.....	95
32.2951.....	65	33.0424.....	77	33.0743.....	82	33.1170.....	95
32.2952.....	65	33.0430.....	77	33.0744.....	82	33.1180.....	96
32.2953.....	65	33.0432.....	77	33.0745.....	82	33.1190.....	93
32.2955.....	65	33.0440.....	78	33.0749.....	84	33.1191.....	93
32.2960.....	65	33.0446.....	78	33.0750.....	84	33.1192.....	93
32.2961.....	65	33.0448.....	78	33.0751.....	84	33.1198.....	94
32.2970.....	65	33.0450.....	78	33.0752.....	84	33.1204.....	96
32.2971.....	65	33.0452.....	78	33.0753.....	84	33.1205.....	96
32.2972.....	65	33.0460.....	78	33.0754.....	85	33.1214.....	96
32.2973.....	65	33.0461.....	78	33.0754.....	85	33.1215.....	96
32.2974.....	65	33.0462.....	78	33.0755.....	85	33.1220.....	96
32.2975.....	65	33.0465.....	78	33.0756.....	85	33.1221.....	96

Kat.Nr. Cat.No. No. Réf. No. Ref. No. Ref.	Seite Page Page Página Pagina	Kat.Nr. Cat.No. No. Réf. No. Ref. No. Ref.	Seite Page Page Página Pagina	Kat.Nr. Cat.No. No. Réf. No. Ref. No. Ref.	Seite Page Page Página Pagina	Kat.Nr. Cat.No. No. Réf. No. Ref. No. Ref.	Seite Page Page Página Pagina
33.1222	96	33.1912	104	33.2055	109	33.2225	116
33.1223	96	33.1915	104	33.2056	109	33.2226	116
33.1400	97	33.1917	104	33.2057	109	33.2230	117
33.1401	97	33.1920	104	33.2060	109	33.2231	117
33.1500	97	33.1921	104	33.2061	109	33.2232	117
33.1506	97	33.1922	104	33.2062	109	33.2233	117
33.1507	97	33.1923	104	33.2063	109	33.2234	117
33.1508	97	33.1924	104	33.2064	109	33.2250	118
33.1509	97	33.1925	104	33.2065	109	33.2255	118
33.1510	97	33.1926	104	33.2066	109	33.2260	118
33.1520	98	33.1927	104	33.2067	109	33.2265	118
33.1530	98	33.1929	105	33.2070	46, 110	33.2270	118
33.1532	98	33.1930	105	33.2072	46, 110	33.2275	118
33.1535	98	33.1932	105	33.2076	46, 110	33.2281	118
33.1537	98	33.1935	105	33.2078	46, 110	33.2310	119
33.1540	98	33.1938	105	33.2085	108	33.2311	119
33.1550	98	33.1940	105	33.2088	110	33.2312	119
33.1552	98	33.1950	105	33.2090	110	33.2320	119
33.1560	99	33.1952	105	33.2091	110	33.2322	119
33.1562	99	33.1960	105	33.2093	110	33.2400	120
33.1603	99	33.1962	105	33.2094	110	33.2401	120
33.1604	99	33.1964	106	33.2095	110	33.2404	120
33.1605	99	33.1966	106	33.2096	110	33.2410	120
33.1613	99	33.1968	106	33.2097	110	33.2411	120
33.1614	99	33.1970	106	33.2110	110	33.2415	120
33.1615	99	33.1972	106	33.2112	110	33.2450	120
33.1620	99	33.1975	106	33.2114	110	33.2500	121
33.1800	100	33.1976	106	33.2116	110	33.2510	121
33.1802	100	33.1978	106	33.2120	111	33.2511	121
33.1804	100	33.1981	107	33.2122	111	33.2512	121
33.1805	100	33.1982	107	33.2124	111	33.2513	121
33.1808	100	33.1983	107	33.2126	111	33.2514	121
33.1810	100	33.1984	107	33.2130	111	33.2515	121
33.1813	100	33.1985	107	33.2132	111	33.2516	121
33.1815	100	33.1986	107	33.2134	111	33.2520	121
33.1816	100	33.1987	107	33.2136	111	33.2522	121
33.1818	100	33.1988	107	33.2140	111	33.2524	121
33.1820	101	33.1989	107	33.2141	111	33.2526	122
33.1830	101	33.1990	107	33.2142	111	33.2527	122
33.1832	101	33.1992	107	33.2143	111	33.2531	121
33.1835	101	33.1994	107	33.2150	112	33.2532	121
33.1836	101	33.1996	107	33.2151	112	33.2533	121
33.1840	101	33.2000	108	33.2152	112	33.2534	121
33.1842	101	33.2001	108	33.2153	112	33.2535	121
33.1844	101	33.2002	108	33.2154	112	33.2536	122
33.1845	101	33.2003	108	33.2155	112	33.2600	123
33.1847	101	33.2004	108	33.2156	112	33.2610	123
33.1850	102	33.2005	108	33.2157	112	33.2612	123
33.1853	102	33.2006	108	33.2158	112	33.2614	123
33.1860	102	33.2007	108	33.2200	115	33.2630	123
33.1862	102	33.2015	108	33.2201	115	33.2639	123
33.1865	102	33.2017	108	33.2210	115	33.2691	124
33.1866	102	33.2018	108	33.2211	115	33.2692	124
33.1867	102	33.2019	108	33.2212	115	33.2693	124
33.1870	102	33.2020	108	33.2213	115	33.2694	124
33.1875	102	33.2021	108	33.2214	115	33.2695	124
33.1880	103	33.2022	108	33.2215	115	33.2696	124
33.1881	103	33.2024	110	33.2216	115	33.2701	124
33.1882	103	33.2025	110	33.2217	115	33.2702	124
33.1883	103	33.2026	110	33.2218	115	33.2703	124
33.1890	103	33.2027	110	33.2219	115	33.2704	124
33.1910	104	33.2028	108	33.2220	115	33.2705	124
33.1911	104	33.2054	109	33.2224	116	33.2706	124

Kat.Nr. Cat.No. No. Réf. No. Ref. No. Ref.	Seite Page Page Página Pagina	Kat.Nr. Cat.No. No. Réf. No. Ref. No. Ref.	Seite Page Page Página Pagina	Kat.Nr. Cat.No. No. Réf. No. Ref. No. Ref.	Seite Page Page Página Pagina	Kat.Nr. Cat.No. No. Réf. No. Ref. No. Ref.	Seite Page Page Página Pagina
33.2710.....	125	34.0080.....	131	34.0259.....	136	34.1117.....	149
33.2711.....	125	34.0100.....	132	34.0290.....	137	34.1121.....	149
33.2712.....	125	34.0101.....	132	34.0299.....	137	34.1122.....	149
33.2713.....	125	34.0102.....	132	34.0301.....	139	34.1123.....	149
33.2714.....	125	34.0103.....	132	34.0303.....	139	34.1127.....	149
33.2720.....	125	34.0120.....	132	34.0305.....	139	34.1128.....	149
33.2721.....	125	34.0121.....	132	34.0307.....	139	34.1129.....	149
33.2722.....	125	34.0122.....	132	34.0309.....	139	34.1205.....	84
33.2723.....	125	34.0123.....	132	34.0311.....	139	34.1207.....	84
33.2724.....	125	34.0140.....	132	34.0313.....	139	34.1209.....	84
33.2801.....	126	34.0141.....	132	34.0321.....	139	34.1211.....	84
33.2802.....	126	34.0142.....	132	34.0323.....	139	34.1213.....	84
33.2803.....	126	34.0143.....	132	34.0327.....	140	34.1215.....	84
33.2804.....	126	34.0144.....	132	34.0329.....	140	34.1217.....	84
33.2805.....	126	34.0145.....	132	34.0330.....	140	34.4020.....	152
33.2811.....	126	34.0146.....	132	34.0331.....	140	34.4022.....	152
33.2812.....	126	34.0148.....	132	34.0333.....	140	34.4030.....	152
33.2813.....	126	34.0149.....	132	34.0335.....	140	34.4040.....	152
33.2814.....	126	34.0150.....	133	34.0342.....	140	34.4042.....	152
33.2815.....	126	34.0151.....	133	34.0343.....	140	34.4100.....	153
33.2901.....	126	34.0152.....	133	34.0370.....	142	34.4102.....	153
		34.0153.....	133	34.0372.....	142	34.4104.....	153
		34.0154.....	133	34.0374.....	142	34.4106.....	153
<b>34...</b>		34.0155.....	133	34.0380.....	142	34.4108.....	153
34.0001.....	128	34.0156.....	133	34.0500.....	143	34.4110.....	153
34.0004.....	128	34.0157.....	133	34.0502.....	143	34.4120.....	153
34.0005.....	128	34.0158.....	133	34.0504.....	144	34.4122.....	153
34.0010.....	128	34.0159.....	134	34.0510.....	143	34.4124.....	153
34.0011.....	128	34.0160.....	134	34.0512.....	143	34.4126.....	153
34.0016.....	128	34.0161.....	134	34.0516.....	144	34.4128.....	153
34.0019.....	128	34.0162.....	134	34.0517.....	144	34.4130.....	153
34.0020.....	128	34.0163.....	134	34.0520.....	142	34.4140.....	154
34.0021.....	128	34.0164.....	134	34.0530.....	142	34.4145.....	154
34.0024.....	129	34.0170.....	134	34.0540.....	144	34.4146.....	154
34.0025.....	129	34.0171.....	134	34.0660.....	148	34.4148.....	154
34.0027.....	129	34.0172.....	134	34.0662.....	145	34.4150.....	155
34.0028.....	129	34.0173.....	134	34.0664.....	145	34.4152.....	155
34.0029.....	129	34.0174.....	134	34.0670.....	145	34.4154.....	155
34.0031.....	129	34.0180.....	135	34.0671.....	145	34.4156.....	155
34.0033.....	129	34.0181.....	135	34.0672.....	146	34.4160.....	156
34.0036.....	129	34.0182.....	135	34.0673.....	146	34.4170.....	156
34.0044.....	129	34.0183.....	135	34.0674.....	146	34.4172.....	156
34.0045.....	130	34.0184.....	135	34.0675.....	146	34.4200.....	157
34.0046.....	130	34.0190.....	135	34.0800.....	147	34.4202.....	157
34.0047.....	130	34.0191.....	135	34.0806.....	147	34.4205.....	157
34.0050.....	130	34.0192.....	135	34.0810.....	147	34.4207.....	157
34.0051.....	130	34.0193.....	135	34.0820.....	147	34.4210.....	159
34.0052.....	130	34.0194.....	135	34.0825.....	147	34.4215.....	159
34.0053.....	130	34.0231.....	136	34.0830.....	147	34.4220.....	158
34.0054.....	130	34.0232.....	136	34.0850.....	147	34.4225.....	158
34.0055.....	131	34.0233.....	136	34.0860.....	147	34.4250.....	160
34.0056.....	131	34.0234.....	136	34.0861.....	147	34.4252.....	160
34.0057.....	131	34.0235.....	136	34.1000.....	148	34.4255.....	160
34.0058.....	131	34.0236.....	136	34.1005.....	148	34.4260.....	160
34.0059.....	131	34.0237.....	136	34.1007.....	148	34.4265.....	160
34.0060.....	131	34.0238.....	136	34.1008.....	148	34.4275.....	160
34.0061.....	131	34.0251.....	136	34.1009.....	148	34.4300.....	161
34.0062.....	131	34.0252.....	136	34.1010.....	148	34.4310.....	161
34.0063.....	131	34.0253.....	136	34.1050.....	148	34.4320.....	161
34.0064.....	131	34.0254.....	136	34.1113.....	149	34.4325.....	161
34.0065.....	131	34.0256.....	136	34.1114.....	149	34.4390.....	161
34.0066.....	131	34.0257.....	136	34.1115.....	149	34.4501.....	162
34.0070.....	131,152	34.0258.....	136	34.1116.....	149	34.4503.....	162
34.0076.....	131						

Kat.Nr. Cat.No. No. Réf. No. Ref. No. Ref.	Seite Page Page Página Pagina	Kat.Nr. Cat.No. No. Réf. No. Ref. No. Ref.	Seite Page Page Página Pagina	Kat.Nr. Cat.No. No. Réf. No. Ref. No. Ref.	Seite Page Page Página Pagina	Kat.Nr. Cat.No. No. Réf. No. Ref. No. Ref.	Seite Page Page Página Pagina
34.4506	162	35.0031	172	35.0624	177	35.3060	198
34.4507	162	35.0032	172	35.0625	177	35.3070	199
34.4509	162	35.0033	172	35.0626	177	35.3071	199
34.4511	162	35.0034	172	35.0643	177	35.3072	199
34.4525	163	35.0035	172	35.0644	177	35.3073	199
34.4527	163	35.0036	172	35.0645	177	35.3074	199
34.4529	163	35.0037	172	35.0646	177	35.3075	199
34.4540	163	35.0038	172	35.0653	177	35.3101	203
34.4542	163	35.0039	172	35.0654	177	35.3102	203
34.4561	161	35.0040	172	35.0655	177	35.3103	203
34.4563	161	35.0045	172	35.0656	177	35.3104	203
34.4570	162	35.0047	172	35.0663	177	35.3105	203
34.4702	164	35.0050	172	35.0664	177	35.3106	203
34.4704	164	35.0051	172	35.0665	177	35.3107	203
34.4706	164	35.0052	172	35.0666	177	35.3108	203
34.4707	164	35.0053	172	35.0703	177	35.3109	203
34.4710	164	35.0054	172	35.0704	177	35.3110	203
34.4715	164	35.0100	173	35.0705	177	35.3111	203
34.4716	164	35.0105	173	35.0706	177	35.3121	203
34.4717	164	35.0110	173	35.0713	177	35.3122	203
34.4730	165	35.0120	173	35.0714	177	35.3123	203
34.4743	165	35.0121	173	35.0715	177	35.3124	203
34.4750	165	35.0122	173	35.0716	177	35.3125	203
34.4760	165	35.0123	173	35.0750	177	35.3126	203
34.4761	165	35.0125	174	35.0752	177	35.3127	203
34.4770	165	35.0127	174	35.0754	177	35.3128	203
34.4772	165	35.0130	174	35.0756	177	35.3129	203
34.5000	166	35.0200	175	35.0760	177	35.3130	203
34.5010	166	35.0220	175	35.0762	177	35.3131	203
34.5012	166	35.0230	175	35.0764	177	35.3500	200
34.5020	166	35.0240	175	35.2000	191	35.3501	200
34.5030	166	35.0250	175	35.2002	191	35.3502	200
34.5100	166	35.0260	175	35.2004	191	35.3504	200
34.5120	167	35.0320	175	35.2006	191	35.3506	200
34.5122	167	35.0400	175	35.2008	192	35.3507	200
34.5124	167	35.0405	175	35.2010	192	35.3508	200
34.5126	167	35.0420	175	35.2012	192	35.3509	200
34.5200	168	35.0430	175	35.2020	195	35.3510	200
34.5202	168	35.0440	175	35.2025	195	35.3511	200
34.5300	169	35.0442	175	35.2030	193	35.3513	200
34.5302	169	35.0444	175	35.2032	193	35.3515	200
34.5304	169	35.0445	175	35.2034	193	35.3530	201
34.5310	169	35.0446	175	35.2040	193	35.3532	201
34.5312	169	35.0448	175	35.2050	193	35.3560	202
34.5314	169	35.0450	175	35.2100	194	35.3561	202
		35.0452	175	35.2102	194	35.3562	202
		35.0460	176	35.2104	194	35.3563	202
		35.0461	176	35.2120	194	35.3564	202
		35.0465	176	35.3000	198	35.3570	201
		35.0468	176	35.3002	198	35.3571	201
		35.0485	176	35.3004	198	35.3600	178
		35.0486	176	35.3006	198	35.3601	178
		35.0487	176	35.3008	198	35.3602	178
		35.0488	176	35.3030	198	35.3603	178
		35.0489	176	35.3032	198	35.3604	178
		35.0490	176	35.3034	198	35.3605	178
		35.0491	176	35.3036	198	35.3606	178
		35.0495	176	35.3038	198	35.3607	178
		35.0603	177	35.3050	198	35.3608	178
		35.0604	177	35.3052	198	35.3609	178
		35.0605	177	35.3054	198	35.3610	178
		35.0606	177	35.3056	198	35.3611	178
		35.0623	177	35.3058	198	35.3612	178
<b>35...</b>							
35.0008	172						
35.0009	172						
35.0010	172						
35.0011	172						
35.0012	172						
35.0013	172						
35.0014	172						
35.0015	172						
35.0016	172						
35.0017	172						
35.0018	172						
35.0019	172						
35.0020	172						
35.0028	172						
35.0029	172						
35.0030	172						



Kat.Nr. Cat.No. No. Réf. No. Ref.	Seite Page Page Página Pagina	Kat.Nr. Cat.No. No. Réf. No. Ref.	Seite Page Page Página Pagina	Kat.Nr. Cat.No. No. Réf. No. Ref.	Seite Page Page Página Pagina	Kat.Nr. Cat.No. No. Réf. No. Ref.	Seite Page Page Página Pagina
35.3620	178	36.0327	208	80.2031	318	80.4004	316
35.3621	178	36.0400	208	80.2032	318	80.4006	316
35.3622	178	36.0500	209	80.2060	318	80.4008	316
35.3623	178	36.0502	209	80.2070	318	80.4010	316
35.3624	178	36.0503	209	80.2072	318	80.4012	316
35.3625	178	36.0504	209	80.2074	318	80.4014	316
35.3626	178	36.0510	209	80.2076	318	80.4040	316
35.3627	178	36.0511	209	80.2078	318	80.4042	316
35.3628	178	36.0512	209	80.2090	318	80.4044	316
35.3629	178	36.0513	209	80.2100	319	80.4046	316
35.3630	178	36.0530	209	80.2101	319	80.4048	316
35.3631	178	36.0531	209	80.2102	319	80.4050	316
35.3632	178	36.0550	210	80.2104	319	80.4052	316
35.3640	178	36.0560	210	80.2200	319	80.4100	321
35.3641	178	36.0600	210	80.2202	319	80.4101	321
35.3642	178	36.0650	210	80.2204	319	80.4102	321
35.3643	178			80.2206	319	80.4103	321
35.3644	178	<b>41...</b>		80.2208	319	80.4104	321
35.3645	178	41.0030	256	80.2210	319	80.6001	302
35.3646	178	41.0031	256	80.2240	319	80.6002	302
35.3647	178	41.0032	256	80.2242	319	80.6003	302
35.3648	178	41.0033	256	80.2244	319	80.6004	302
35.3649	178	41.0034	256	80.2246	319	80.6005	302
		41.0035	256	80.2248	319	80.6006	302
<b>36...</b>		41.0037	256	80.2250	319	80.6011	302
36.0010	206			80.2252	319	80.6012	302
36.0011	206	<b>48...</b>		80.2254	319	80.6013	302
36.0012	206	48.0004	264	80.2256	319	80.6014	302
36.0013	206	48.0006	264	80.2258	319	80.6015	302
36.0014	206	48.0010	264	80.2260	319	80.6016	302
36.0015	206	48.0011	264	80.2262	319	80.6021	302
36.0016	206	48.0014	264	80.2270	319	80.6022	302
36.0017	206	48.0020	267	80.2272	319	80.6023	302
36.0018	206	48.0024	267	80.2280	320	80.6024	302
36.0019	206	48.0030	267	80.2282	320	80.6025	302
36.0050	206	48.0032	267	80.2284	320	80.6026	302
36.0051	206	48.0034	267	80.2286	320	80.6031	302
36.0052	206	48.0035	267	80.2288	320	80.6032	302
36.0053	206	48.0036	267	80.2290	320	80.6033	302
36.0054	206	48.0062	268	80.2292	320	80.6034	302
36.0055	206	48.0064	268	80.2300	320	80.6035	302
36.0056	206	48.0072	268	80.2302	320	80.6036	302
36.0057	206	48.0082	268	80.2310	320	80.6041	302
36.0058	206	48.0086	268	80.2315	320	80.6042	302
36.0059	206	48.0089	269	80.2400	321	80.6043	302
36.0060	206	48.0090	269	80.2401	321	80.6044	302
36.0061	206	48.0092	269	80.2402	321	80.6045	302
36.0062	206	48.0094	269	80.2406	321	80.6046	302
36.0063	206	48.0098	269	80.2407	321	80.6203	303
36.0064	206	48.0099	269	80.2408	321	80.6205	303
36.0065	206			80.2430	321	80.6207	303
36.0100	207	<b>80...</b>		80.2432	321	80.6210	303
36.0110	207	80.0010	317	80.2434	321	80.6231	303
36.0120	55,207	80.0012	317	80.2436	321	80.6232	303
36.0150	207	80.0014	317	80.2438	321	80.6240	303
36.0152	207	80.1000	317	80.3112	316	80.6301	304
36.0300	207	80.1002	317	80.3114	316	80.6302	304
36.0310	207	80.1010	317	80.3116	316	80.6303	304
36.0312	207	80.1012	317	80.3162	316	80.6304	304
36.0320	208	80.2000	317	80.3164	316	80.6305	304
36.0322	208	80.2009	317	80.3166	316	80.6306	304
36.0324	208	80.2020	318	80.3190	315	80.6311	304
36.0325	208	80.2030	318	80.4002	316	80.6312	304

Kat.Nr. Cat.No. No. Réf. No. Ref. No. Ref.	Seite Page Page Página Pagina
80.6313.	304
80.6314.	304
80.6315.	304
80.6316.	304
80.6321.	304
80.6322.	304
80.6323.	304
80.6324.	304
80.6325.	304
80.6326.	304
80.6503.	305
80.6505.	305
80.6507.	305
80.6510.	305
80.6531.	305
80.6532.	305
80.6540.	305
80.6541.	305
80.6601.	306
80.6602.	306
80.6603.	306
80.6604.	306
80.6605.	306
80.6606.	306
80.6611.	306
80.6612.	306
80.6613.	306
80.6614.	306
80.6615.	306
80.6616.	306
80.6621.	306
80.6622.	306
80.6623.	306
80.6624.	306
80.6625.	306
80.6626.	306
80.6631.	306
80.6632.	306
80.6633.	306
80.6634.	306
80.6635.	306
80.6636.	306
80.6641.	306
80.6642.	306
80.6643.	306
80.6644.	306
80.6645.	306
80.6646.	306
80.6803.	307
80.6805.	307
80.6807.	307
80.6810.	307
80.6813.	307
80.6815.	307
80.6817.	307
80.6820.	307
80.6841.	307
80.6842.	307
80.6850.	307
80.6851.	307
80.7001.	308
80.7002.	308
80.7003.	308

Kat.Nr. Cat.No. No. Réf. No. Ref. No. Ref.	Seite Page Page Página Pagina
80.7004.	308
80.7005.	308
80.7006.	308
80.7011.	308
80.7012.	308
80.7013.	308
80.7014.	308
80.7015.	308
80.7016.	308
80.7301.	308
80.7302.	308
80.7303.	308
80.7304.	308
80.7305.	308
80.7306.	308
80.7311.	308
80.7312.	308
80.7313.	308
80.7314.	308
80.7315.	308
80.7316.	308
80.7321.	308
80.7322.	308
80.7323.	308
80.7324.	308
80.7325.	308
80.7326.	308
80.7410.	309
80.7420.	309
80.7431.	309
80.7501.	310
80.7503.	310
80.7504.	310
80.7511.	310
80.7513.	310
80.7514.	310
80.7551.	310
80.7552.	310
80.7553.	310
80.7901.	311
80.7902.	311
80.7903.	311
80.7904.	311
80.7905.	311
80.7906.	311
80.7911.	311
80.7912.	311
80.7913.	311
80.7914.	311
80.7915.	311
80.7916.	311
80.7950.	311
80.7960.	311
80.7962.	311
80.7980.	311
80.8000.	312
80.8010.	312
80.8050.	312
80.8052.	312
80.8054.	312
80.8060.	313
80.8062.	313
80.8064.	313

Kat.Nr. Cat.No. No. Réf. No. Ref. No. Ref.	Seite Page Page Página Pagina
80.8100.	313
80.8105.	313
80.8110.	313
80.8115.	313
80.8120.	313
80.8131.	313
80.8132.	313
80.8133.	313
80.8140.	314
80.8141.	314
80.8142.	314
80.8150.	314
80.8160.	314
80.8161.	314
80.8162.	314
80.8163.	314
80.8164.	314
80.8191.	314
80.8192.	314
80.8201.	315
80.8202.	315
80.8211.	315
80.8212.	315
80.8213.	315
80.8214.	315
80.8221.	315
80.8222.	315
80.8223.	315
80.8224.	315

